

elco

HEATING

CATALOGUE



elco

HEATING

CATALOGUE

THE COMPANY	_____	p. 4
RANGE OVERVIEW	_____	p. 16
GAS BURNERS	_____	p. 26
DUAL FUEL BURNERS	_____	p. 154
LIGHT OIL BURNERS	_____	p. 180
BIOFUEL BURNERS	_____	p. 216
KIT & OPTIONS	_____	p. 218



CUTTING-EDGE BURNERS FOR HEATING AND INDUSTRIAL APPLICATIONS

OUR COMPANY

Since its foundation in 1928, ELCO has always been a specialist in burners conception and manufacturing. By linking a strong innovative ability to a continued developing drive, ELCO has designed high performing and reliable burners as well as corresponding services throughout the years, and is today one of the leaders in the field of combustion technology.



OUR MISSION

ELCO always looks for the best technologies and continues to develop new ones to improve the efficiency of its solutions.

Our R&D Laboratories are committed to develop innovative technological solutions allowing to:

- optimise the running of the installations lowering costs;
- offer service friendly products easy to maintain;
- preserve the environment lowering acoustic and pollutant emissions.



OUR KNOWLEDGE

Your contacts at ELCO and its partners are recognised experts with years of experience. Our worldwide support starts from concept creation to planning, design and project management up to commissioning and on-going operation of the plant throughout its life cycle.

As an ELCO customer, you can count on us for products that guarantee reliability, quality and high performance in any application and working condition.



OUR SERVICE NETWORK

Taking advantage of a staff composed of technicians and engineers with a long experience, ELCO is able to provide professional support to the customer in order to define together the best solution and to develop and manage the project through its entire life-cycle.

ELCO Service activities define the standards in the market and each customer can rely on high performance and reliable products.



OUR INNOVATIVE SOUL

A perfect mix of experience and spirit of innovation gives ELCO the push to constantly refine its products and develop new ones to respond to market demands, in particular those related to the reduction of polluting emissions.

The growing attention to issues related to the environment has led to the development of advanced combustion technologies that use alternative fuels, as happens for example with hydrogen burners, a product of the future that ELCO is already able to offer today.



OUR PRODUCT RANGE

Our experience at combustion technology available in a complete range of burners from 11 kW to 80 MW:

Monoblock range:



VECTRON
11 - 2300 kW
 Gas
 Light oil
 Dual fuel
 Biofuel



PROTRON
15 - 550 kW
 Gas
 Light oil



EK-TRON
340 - 6050 kW
 Gas



NEXTRON
250 - 11200 kW
 Gas
 Light oil
 Dual fuel



EK EVO
250 - 13500 kW
 Gas
 Light oil
 Dual fuel



N
1300 - 22000 kW
 Gas
 Light oil
 Dual fuel



HO-TRON
68 - 17000 kW
 Heavy oil



GHO-TRON
414 - 17000 kW
 Heavy oil
 Dual fuel

Duoblock range:



D-TRON
230 - 34000 kW
 Gas
 Light oil
 Gas / light oil
 Heavy oil
 Gas / heavy oil



EK-DUO
600 - 16000 kW
 Gas
 Light oil
 Dual fuel

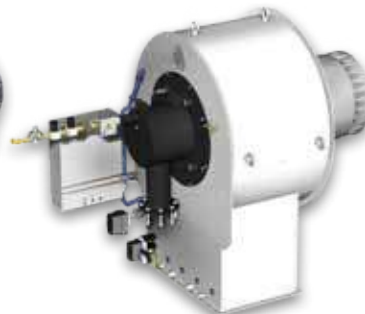

RPD N
3000 - 80000 kW
 Gas



RPD
500 - 80000 kW
 Gas
 Light oil
 Gas / light oil
 Heavy oil
 Gas / heavy oil

ALTERNATIVE FUELS AND SUSTAINABLE PRODUCTS

The development of products suitable to work with alternative fuels has recently become one of the main focuses in the heating business and, consequently, also involves the burner sector.

Fuels such as biofuels, HVO, etc., are receiving particular attention because they represent a real alternative to traditional liquid fuels without implying expensive modifications to existing plants and equipments:



BIOFUEL

Biofuels such as biodiesel (made primarily from oily plants) and bioethanol (made by fermenting starch or sugar) are liquid or gaseous fuels made from biomass.

Liquid biofuels are of particular interest because they are nearly identical to the petroleum-based fuels they are designed to replace, so they can be blended with traditional liquid fuels and are compatible with today's engines, pumps, and other infrastructure.



HVO

HVO stands for "Hydrotreated Vegetable Oil", sometimes known as Renewable Diesel.

This type of fuel is produced from waste, residue oils and fats, such as used cooking oil.

It is also specially formulated to deliver a cleaner burn, and produces significantly lower NOx and particulate matter.

HVO fuel comes in all kinds of blends and it can be used pure (100% concentration) or blended in any ratio with e.g. fossil diesel.



GTL

GTL stands for "Gas to Liquid" and is a synthetic diesel alternative made from natural gas. It is a non-toxic paraffin free of unwanted sulphur, metals and aromatics, and is readily biodegradable, representing a clean fuel with limited environmental impact. It is considered a direct drop-in alternative to conventional diesel, since it doesn't imply additional investment or modifications to existing infrastructure.



BIOGAS

Biogas is one of the most used alternative sources for renewable energy production.

It is a mixture of gases with high calorific power, primarily consisting of methane, carbon dioxide and hydrogen sulphide, result of the fermentation, in the absence of oxygen and at controlled temperature, of substances of organic origin such as agricultural waste, manure, municipal waste, plant material, sewage, green waste and food waste.

ELCO has decades of experience in the design of low emission burners thanks to its advanced combustion technologies and recently has been committed to the development of products capable of operating efficiently and reliably with these new fuels: the goal is to become a supplier not only of high performance products but also of solutions capable to reduce their environmental impact and help create a more sustainable future.

See page 216 to discover our new range of **VECTRON BIO** models developed to work with **Biofuel F30**, and contact us to find out more about all the products working with alternative fuels that we can offer.



ELCO SYSTEMS AND TECHNOLOGIES

To constantly improve its products, ELCO is committed to develop innovative technological solutions allowing to optimise the running of the installations, to ease technicians work, and naturally to preserve the environment. In order to provide quick responses to its market's demands, the range of ELCO burners is entirely conceived around a consistent combination of Systems.

MDE2 SYSTEM

Permanent communication of information easy to use



Equipped with the MDE2 System, the universal language Elcogram and the 5-button keypad, ELCO burners adjust themselves and constantly communicate to the technicians and operators:

- real time information about each ignition and during the running;
- statistical information about the burner operations recorded during the whole year before the maintenance operations.

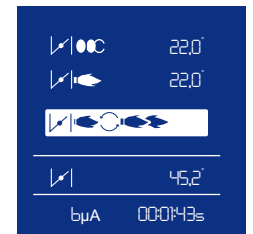
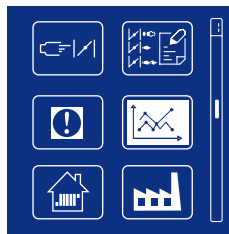
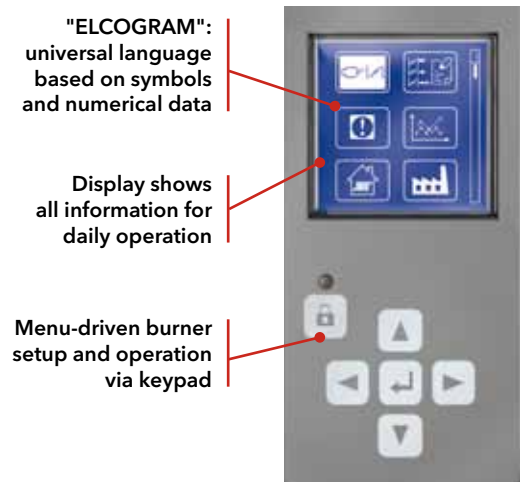

Elcogram, a universal language
As ELCO products are distributed worldwide, the company has developed a universal language composed of pictograms and numerical data. The pictograms use the majority of the symbols used on the wiring diagrams which are recognised and understood by all Nations. This ensures that information is easier to read than ever before.

GEM SYSTEM

Electronic burner control: high safety and low costs



The use of electronic technologies in burner control systems helps to reduce running costs, improve reliability of operation and lower pollutant emissions. The electronic combustion manager used on ELCO burners are responsible not only for the burner control (formerly the task of the traditional automatic combustion control unit) but also for fuel/air regulation. Data stored electronically has replaced the mechanical characteristic curve and help to achieve an unprecedented level of precision in air/fuel ratio regulation across the burner's entire control range, a prerequisite for efficient, energy- and cost-saving operation.

The GEM System controls the position of one or more activators simultaneously.

The servomotors of the air flow and oil components are controlled by a microprocessor which contains set points defined for each load curve. An additional advantage of the GEM is that it provides specific information on all the commands and current situation of the overall system: these can be accessed directly or by remote control.

The digital programming is user-friendly, it is carried out through the display of the MDE2 System or through a PC by using a simple procedure facilitated by easy instructions in a clear language.

ELCO SYSTEMS AND TECHNOLOGIES

AGP SYSTEM

An outstanding technology for gas burners



Developed and produced by ELCO, the AGP System (proportional air-gas) provides:

- perfect stability of the air-gas mixture;
- a constantly high CO₂ content over the whole burner power range;
- precise control of air excess, which is important for high-efficiency operation, in particular for condensing generators.

The AGP measures: the gas pressure downstream of the gas train, the air pressure behind the flame holder and the furnace backpressure.

Any variations in the three pressures are immediately and simultaneously recorded by the system which automatically restores the correct gas/combustion air ratio.

AGP maintains a constant gas/combustion air ratio even in the presence of:

- positive or negative variations in the gas pressure;
- variations in air flow due to changes in the electrical supply voltage or fouling of the ventilation system;
- variations in the furnace and flue draft pressure on start-up and during load changes.

VARIATRON

Speed regulation: noise reduction and energy saving



To improve the performance of heating or industrial systems, ELCO applies Variatron (fan speed control).

Conventionally, the air in modulating burners is regulated by an air flap. In the partial load range, a large amount of the air pressure generated by the ventilator goes to waste.

With speed regulation, the speed of the combustion-air fan is varied continuously depending on the burner output required. Full speed is reached only at maximum burner output. In the predominant partial load range, lower speed translates into significant reductions in power consumption and noise emissions.

The Variatron operates in step with the air damper both with the GEM System and with the AGP System, which guarantees a combustion with minimum air excess by continuously monitoring all operating conditions.

Application of the Variatron to ELCO burners results in:

- electrical consumption savings in the order of 50%;
- turndown ratio of up to 1:10, resulting in perfect adaptation to system requirements and improvement in average seasonal efficiency, in particular with condensing or low-temperature boilers or specific processes;
- silent start-up and average overall noise reduction between 2 dB(A) (at maximum power) and 12 dB(A) (at minimum power).

LOW NOISE SYSTEM

Increase the comfort in-use and protect the environment



Among all the harmful things that people have to bear with every day life, the most annoying is noise, which is difficult to reduce and expensive to reduce.

This is the reason why ELCO has developed quiet burners both by selecting sound absorbent materials, and by treating each noise sources internally. The main noise comes from the air intake and the air mixing in the fan wheel: all the ELCO burners are equipped with a sound trap on the air intake channel leading to the fan.

This brings the acoustic level to an acceptable value in respect of the environment.

COMBUSTION TECHNOLOGIES

DIAMOND HEAD

Low emissions and reliable operation



The principle of the Diamond Head technology is based on the internal recirculation of the combustion flue gases. The gases are partially drawn into the base of the flame via triangular openings placed at the end of the combustion head.



The position and geometry of the gas injectors are such that a significant quantity of combustion flue gas is drawn in and rapidly mixed with air and gas at the root of the flame. This mixture crosses the main reaction area, slowing the combustion, which resulted in lowering the main flame temperature. The result of this staging combustion is a significant reduction in the formation of thermal nitrogen oxides. The advantage of this technique is an automatic adjustment to the quantity of recycled combustion flue gases: the volume of the flame is always as low as possible, which has a very minor effect on the nominal power of the generator, unlike external recirculation systems.

FREE FLAME

The pinnacle of low-polluting burner engineering



The Free Flame combustion technology is based on the internal recirculation of the flue gas, combined with high speed flow of the fuel air mixture. The flame stabilizes at a certain distance from the combustion head, thus leaving space for the mixture of reagents and flue gas. This phenomenon greatly reduces NOx emissions.

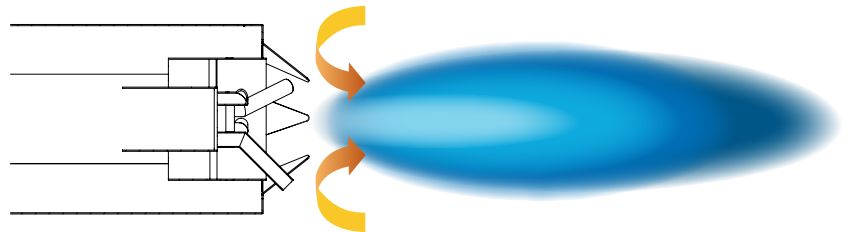

The flame seems to float in the furnace, thus giving the system its name: "Free Flame".

FGR SYSTEM

Ultra low NOx solutions to reach emissions of less than 30 mg/kWh



ELCO offers a wide range of products which use the external FGR technology to reduce NOx emissions and satisfy even the most stringent regulations.

The principle of external flue gas recirculation consists in sending a mixture of comburent air and flue gas to the combustion head, thus reducing the NOx emissions. The gases are mixed upline of the combustion process by the burner fan (for mono-block units) or by the external fan (in case of duoblock burners). This technology enables ELCO to guarantee emissions of less than 30 mg/kWh, a value which is hard to obtain with conventional combustion systems, and offer cutting-edge products which satisfy the requirements of any current regulations.

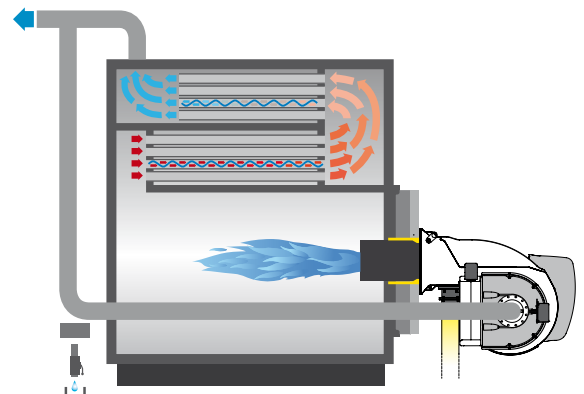

WORLDWIDE NETWORK

Capitalising on more than 90 years of work experience, ELCO has been capable to build up loyal partnerships and today can count on reliable Partners all over the World.

Combining an instinctively global perspective with a genuinely multicultural approach ELCO today offers you skilled and experienced experts available in more than 70 Countries.

In Europe

3 production plants
6 commercial branches
Strong commercial presence
through a network of reliable
dealers and partners

Worldwide

2 Sales Offices in Russia and China
Distribution in over 70 Countries



Service Network

In Western Europe, ELCO has a well organised service network. Outside Western Europe ELCO uses a network of partners, consisting of well-trained local engineers, to carry out its service operations. These technicians are able to perform both commissioning and local service and they do it in a very professional and efficient way.

BURNER ACADEMY

In order to respond to the needs of our customers we created a Burner Academy, a real training school where the knowledge of our technicians is passed on to our trainees. We provide the opportunity for boiler room personnel, operators and engineers to attend a series of training sessions carried out on our test bench by highly qualified instructors, who hold the courses in English, German, French, Italian and Dutch language.

The Burner Academy uses various training locations where boilers are installed and where people can be trained in theory and in practice. We offer courses at different levels and also the possibility to handle all your needs in a customer-specific training.



RELIABLE SUPPLY OF SPARE PARTS

Spare parts have always had a great importance inside the ELCO world. Considering the high amount of parts involved in every single product, some of these parts might naturally need to be replaced. ELCO can count on an International network offering original spare parts in order to guarantee the highest quality, reliability and safe continued operation of the appliance.

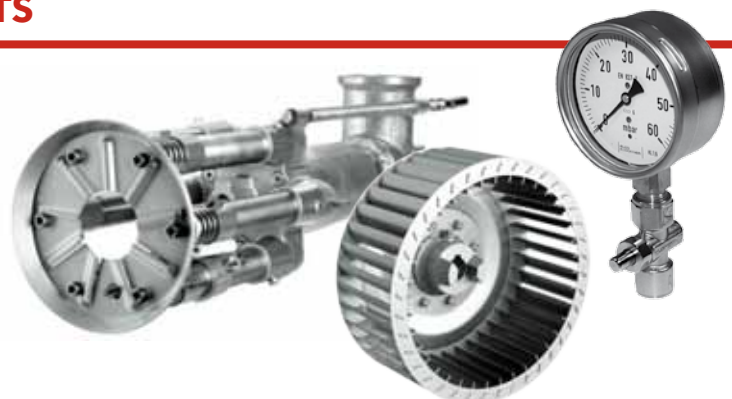

WORLDWIDE REFERENCES

Musselkanaal, The Netherlands

Fuel:

Natural gas

Total nominal output:

1600 kW

Burners:

2x VG4.610 M



Altchemnitz, Germany

Fuel:

Natural gas

Total nominal output:

132 MW

Burners:

6x N11.22000 G-EU1



Velikiye Luki, Russia

Fuel:

Natural gas and dual fuel (gas/light oil)

Total nominal output:

13 MW

Burners:

2x EK EVO 7.3600 G-E

1x EK EVO 7.4500 GL-EZ3



WORLDWIDE REFERENCES

Vries, The Netherlands

Fuel:
Natural gas

Total nominal output:
350 kW

Burners:
1x VG3.350 D E



Beijing, China

Fuel:
Natural gas

Total nominal output:
180 MW

Burners:
4x RPD 100 G-EU



Seoul, South Korea

Fuel:
Natural gas

Total nominal output:
50 MW

Burners:
7x N8.7100 G-EU3



WORLDWIDE REFERENCES

Beijing, China

Fuel:

Natural gas

NOx emissions:

Installation with FGR system to reach
NOx levels below 30 mg/kWh

Burners:

1x EK EVO 8.5800 G-EU3 FGR
2x EK EVO 8.7100 G-EU3 FGR



Bialystok, Poland

Fuel:

Natural gas

Total nominal output:

41 MW

Burners:

2x RPD 70 G-EU2



Seoul, South Korea

Fuel:

Natural gas and dual fuel

Total nominal output:

80 MW

Burners:

3x N10.16000.45 G-EU2 FGR
1x N10.12000.37 GL-EUF



WORLDWIDE REFERENCES

Monza, Italy

Fuel:
Natural gas

NOx emissions:
Installation with FGR system to reach
Ultra NOx emission levels

Burners:
1x N11.19000 G-EU2



Stavanger, Norway

Location:
District heating plant

Fuel:
Natural gas

Burners:
2x EK-DUO 4.1600 G-E



Beijing, China

Fuel:
Natural gas

NOx emissions:
Installation with FGR system to reach
NOx levels below 30 mg/kWh

Burners:
2x N10.16000 G-EU2 FGR



VECTRON



MAIN FEATURES

- Fuels: natural gas (G20/G25, $H_u = 8,83...10,35 \text{ kWh/m}^3$) and LPG (G31, $H_u = 25,89 \text{ kWh/m}^3$).
light oil and biofuel (viscosity $6 \text{ mm}^2/\text{s}$ at 20°C , $H_u = 11,86 \text{ kWh/kg}$)
- Cubic type architecture allowing optimal accessibility, maximum compactness, minimum weight.
- Complete electrical equipment in the body of the burner with MDE2 System and display: this ensures that information is easier to read than ever before, constantly giving real-time information to professional operators, during the commissioning, the operation and at each operation cycle.
- Quiet ventilation and reduced electrical consumption.
- Closing of the air flap at burner shut-down.
- Maintenance operation are simplified: the combustion parts can be quickly removed, easily cleaned and, even when they are disassembled, they easily get back to their position after all the servicing work.
- Gas train factory assembled and tested for tightness and electrical security.
- All products are in compliance with EN676 and EN267 European standards and with the following directives:
 - 2014/35/EU Low Voltage Directive
 - 2014/30/EU EMC Directive
 - 2016/426/EU Gas Appliance Regulation
 - 2006/42/EC Machine Directive
- All products up to VG4.440 and VL4.440 D are in compliance with ErP Directive

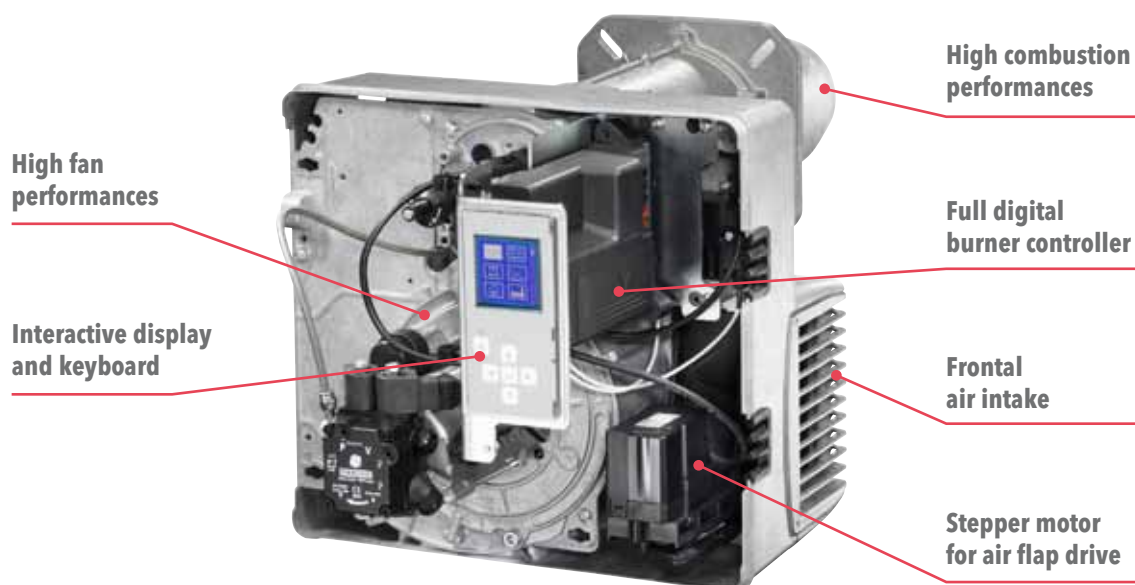

EK EVO**MAIN FEATURES**

EK EVO 4 and 5 are two stage progressive/modulating forced draught burners, working with light oil and equipped with low emission combustion technology, that makes these burner series able to outperform the most rigid regulation in terms of pollutant emissions.

- Fuel: light oil (viscosity 6 mm²/s at 20°C, Hu = 11,86 kWh/kg)
- Fully electronic modulation system for a smooth and efficient operation of the burner (GEM System)
- Low NO_x class 3 combustion head providing NO_x values well below the limit of 120 mg/kWh imposed by the EN267/2020 Directive
- Simple and intuitive switch cabinet to meet the majority of the application requirements
- Backlit display with a 5-buttons keyboard on the switch cabinet providing real-time information on the operation of the burner through ELCOGRAM, the ELCO universal language based on symbols and numerical data
- Burner control, power regulator and all other options can be installed on the switch cabinet thanks to a modular concept design
- Easily adjustable sliding combustion head with dedicated servomotor assuring high adaptability to varying boiler situations and required emission level
- Secured burner head adjustments for easy and fast maintenance operations (RTC System)
- Closing of the air damper on burner shut-down
- Versions for continuous operation available (PED configuration)
- All products are in compliance with EN267 European standards and with the following directives:
 - 2014/35/EU Low Voltage Directive
 - 2014/30/EU EMC Directive
 - 2006/42/EC Machine Directive

NO_x EMISSION VALUES

The EK EVO 4 and 5 are equipped with Low NO_x combustion head that makes these burners able to work below 80 mg/kWh, well below the limit of 120 mg/kWh imposed by the EN267/2020 Directive.

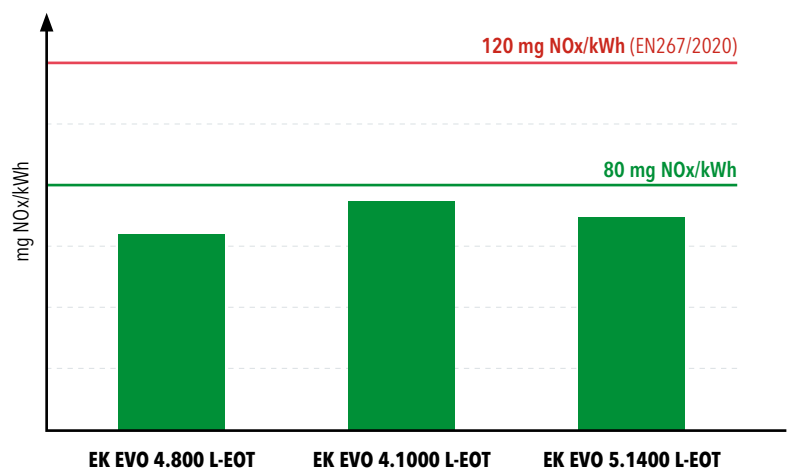

BURNERS

FUEL AND COMBUSTION TYPE

- G** = Natural gas
- GL** = Dual fuel (natural gas/light oil)
- L** = Light oil standard
- B** = Light oil Low NOx Blue flame
- E** = Light oil Low NOx Yellow flame

ERP COMPLIANCE

- = not compliant
- E** = compliant (for gas only)

ADDITIONAL EQUIPMENT

- /TC** = Tightness control
- /PED** = PED equipped
- /FGR** = FGR equipped

HEAD LENGTH

- KN** = short
- KM** = medium
- KL** = long

ELECTRICAL SUPPLY

- = 230V / 50Hz
- 6H** = 230V / 60Hz
- 110** = 110-120 V/50-60 Hz

VG3.290 M E /TC KN 6H

PLATFORM

From **1** to **6**

SIZE

Max power (kW)

OPERATION TYPE

- = 1 stage
- P** = 1 stage standard with pre-heater (light oil)
- D** = 2 stages
- DP** = 2 stage progressive/modulating pneumatic Low NOx (gas) / 3 stages (light oil)
- DP R** = 2 stage progressive/modulating pneumatic
- V** = 2 stage progressive/modulating pneumatic + fan speed control
- VD** = 2 stages PWM Low NOx (light oil)
- M** = 2 stage progressive/modulating electronic Low NOx
- M R** = 2 stage progressive/modulating electronic
- M V** = 2 stage progressive/modulating electronic Low NOx + fan speed control
- M V R** = 2 stage progressive/modulating electronic + fan speed control

RANGE

EK EVO
Platform **4** and **5**

OPERATION TYPE

E = 2 stage progressive/
modulating electronic

COMBUSTION TYPE

OT = Low NOx class 3 (according to EN267)
with optimisation of air flow rate

EK EVO 4.1000 L-EOT /BT3 /PED

SIZE

Approximate
power (kW)

FUEL

L = Light oil

ELECTRICAL
EQUIPMENT

/BT3 = BT300

OPTIONAL CONFIGURATIONS

/PED = continuous operation

GAS TRAINS

VALVE MANUFACTURER

d = Dungs
s = Siemens
k = Kromschröder
h = Honeywell

VALVE NOMINAL DIAMETER

1/2" ... 2" or 50 ... 100 mm

GAS TRAIN CONNECTION DIAMETER

Rp1/2" ... Rp2" (when threaded) or DN50 ... 100 (when flanged)

d335 - 1"1/2 - Rp2" /TC 110

OPERATION TYPE

1 = 1 stage
2 = 2 stages
3 = Pneumatic
4 = Electronic

SERIES

Progressive number

ADDITIONAL EQUIPMENT

/TC = Tightness control

ELECTRICAL SUPPLY

- = 230V / 50Hz
110 = 110-120 V/50-60 Hz

OTHER BURNER VERSIONS

- 60 60 Hz version
- TC Version with tightness control
- Ver Versions for continuous ventilation and post-ventilation
- PED PED version for continuous operation
- ErP ErP compliant

ONE STAGE / Low NOx

VG1.40 E /TC	60	VENT	ErP	15 ... 41 kW		p. 26
VG1.55 E /TC	60	VENT	ErP	35 ... 55 kW		p. 26
VG1.105 E /TC	60	VENT	ErP	50 ... 105 kW		p. 26
VG2.140 E	60	VENT	ErP	80 ... 140 kW		p. 28
VG2.205 E	60	VENT	ErP	130 ... 205 kW		p. 28

TWO STAGES / Low NOx

VG1.105 D E	60	VENT	ErP	37 ... 105 kW		p. 30
VG2.90 D E	60	VENT	ErP	20 ... 90 kW		p. 32
VG2.120 D E	60	VENT	ErP	40 ... 120 kW		p. 32
VG2.160 D E	60	VENT	ErP	50 ... 160 kW		p. 32
VG2.205 D E	60	VENT	ErP	65 ... 205 kW		p. 32
VG3.290 D E	60	TC	VENT	ErP	95 ... 290 kW	p. 36
VG3.350 D E	60	TC	VENT	ErP	105 ... 350 kW	p. 36
VG4.440 D E	60	TC	VENT	ErP	110 ... 440 kW	p. 40
VG4.460 D	60	TC	VENT	150 ... 460 kW		p. 44









































TWO STAGE PROGRESSIVE/MODULATING PNEUMATIC / Low NOx

VG2.90 DP E	60	VENT	ErP	20 ... 90 kW		p. 48
VG2.120 DP E	60	VENT	ErP	40 ... 120 kW		p. 48
VG2.160 DP E	60	VENT	ErP	50 ... 160 kW		p. 48
VG2.205 DP E	60	VENT	ErP	65 ... 205 kW		p. 48
VG3.290 DP E	60	TC	VENT	ErP	95 ... 290 kW	p. 52
VG3.350 DP E	60	TC	VENT	ErP	105 ... 350 kW	p. 52
VG4.440 DP E	60	TC	VENT	ErP	110 ... 440 kW	p. 56
VG4.460 DP	60	TC	VENT	100 ... 460 kW		p. 60
VG4.610 DP	60	TC	VENT	130 ... 610 kW		p. 60
VG5.750 DP	60	TC	VENT	160 ... 800 kW		p. 64
VG5.950 DP	60	TC	VENT	170 ... 950 kW		p. 68
VG5.1200 DP	60	TC	VENT	250 ... 1160 kW		p. 68
VG6.1600 DP /TC	60	VENT		300 ... 1600 kW		p. 72
VG6.2100 DP /TC	60	VENT		400 ... 1900 kW		p. 72















TWO STAGE PROGRESSIVE/MODULATING PNEUMATIC + fan speed control / Low NOx

VG2.205 V E		VENT	ErP	65 ... 205 kW		p. 76
VG3.290 V E	TC	VENT	ErP	95 ... 290 kW		p. 78
VG3.350 V E	TC	VENT	ErP	105 ... 350 kW		p. 78
VG4.440 V E	TC	VENT	ErP	110 ... 440 kW		p. 82
VG4.460 V	TC	VENT		100 ... 460 kW		p. 86
VG4.610 V	TC	VENT		130 ... 610 kW		p. 86















TWO STAGE PROGRESSIVE/MODULATING ELECTRONIC / Low NOx

VG2.90 M E /TC	 	20 ... 90 kW							p. 90
VG2.120 M E /TC	 	40 ... 120 kW							p. 90
VG2.160 M E /TC	 	50 ... 160 kW							p. 90
VG2.205 M E /TC	 	65 ... 205 kW							p. 90
VG3.290 M E /TC	 	95 ... 290 kW							p. 94
VG3.350 M E /TC	 	105 ... 350 kW							p. 94
VG4.440 M E /TC	 	110 ... 440 kW							p. 98
VG4.460 M /TC		86 ... 460 kW							p. 102
VG4.610 M /TC		90 ... 610 kW							p. 102
VG5.750 M /TC	 	160 ... 800 kW							p. 106
VG5.950 M /TC	 	160 ... 900 kW							p. 110
VG5.1200 M /TC	 	160 ... 1160 kW							p. 110
VG6.1600 M /TC	 	240 ... 1600 kW							p. 114
VG6.2100 M /TC	 	260 ... 1900 kW							p. 114













TWO STAGE PROGRESSIVE/MODULATING ELECTRONIC + fan speed control / Low NOx

VG5.750 M V /TC	 	160 ... 800 kW							p. 118
VG5.950 M V /TC	 	160 ... 900 kW							p. 122
VG5.1200 M V /TC	 	160 ... 1160 kW							p. 122
VG6.1600 M V /TC	 	240 ... 1600 kW							p. 126
VG6.2100 M V /TC	 	260 ... 1900 kW							p. 126













TWO STAGE PROGRESSIVE/MODULATING PNEUMATIC

VG5.950 DP R	  	150 ... 1000 kW							p. 130
VG5.1200 DP R	  	200 ... 1200 kW							p. 130
VG6.1600 DP R /TC	 	200 ... 1700 kW							p. 134
VG6.2100 DP R /TC	 	300 ... 2300 kW							p. 134





TWO STAGE PROGRESSIVE/MODULATING ELECTRONIC

VG5.950 M R /TC	 	150 ... 1000 kW							p. 138
VG5.1200 M R /TC	 	200 ... 1200 kW							p. 138
VG6.1600 M R /TC	 	200 ... 1700 kW							p. 142
VG6.2100 M R /TC	 	300 ... 2300 kW							p. 142





TWO STAGE PROGRESSIVE/MODULATING ELECTRONIC + fan speed control

VG5.950 M V R /TC	 	150 ... 1000 kW							p. 146
VG5.1200 M V R /TC	 	200 ... 1200 kW							p. 146
VG6.1600 M V R /TC	 	200 ... 1700 kW							p. 150
VG6.2100 M V R /TC	 	300 ... 2300 kW							p. 150





ONE STAGE in gas and in oil

VGL2.120		35 ... 120 kW		p. 154
VGL2.210		100 ... 190 kW		p. 154









TWO STAGES in gas and in oil / Low NOx

VGL3.290 D		95 ... 290 kW		p. 156
VGL3.360 D		120 ... 360 kW		p. 156









TWO STAGE PROGRESSIVE/MODULATING PNEUMATIC / Low NOx in gas / TWO STAGES in oil

VGL4.460 DP		168 ... 460 kW		p. 160
VGL4.610 DP		190 ... 610 kW		p. 160









TWO STAGE PROGRESSIVE/MODULATING ELECTRONIC / Low NOx in gas / THREE STAGES in oil

VGL5.700 M /TC		200 ... 700 kW		p. 164
VGL5.1000 M /TC		240 ... 1000 kW		p. 164
VGL6.1600 M /TC		300 ... 1600 kW		p. 168
VGL6.2100 M /TC		480 ... 2050 kW		p. 168

TWO STAGE PROGRESSIVE/MODULATING ELECTRONIC + fan speed control / Low NOx in gas / THREE STAGES in oil







VGL5.700 M V /TC		200 ... 700 kW		p. 172
VGL5.1000 M V /TC		240 ... 1000 kW		p. 172
VGL6.1600 M V /TC		300 ... 1600 kW		p. 176
VGL6.2100 M V /TC		480 ... 2050 kW		p. 176

ONE STAGE / Low NO_x, Yellow Flame

VE1.34	 	16 ... 34 kW		p. 180
VE1.50	 	28 ... 50 kW		p. 180
VE1.75	 	44 ... 75 kW		p. 180















0 20 40 60 80 100 kW

TWO STAGES / Low NO_x, Yellow Flame

VE2.100 D	 	50 ... 100 kW		p. 182
VE2.150 D	 	65 ... 150 kW		p. 182





















0 50 100 150 200 250 kW

ONE STAGE / Low NO_x, Blue Flame

VB1.20	 	11 ... 20 kW		p. 184
VB1.24	 	14 ... 24 kW		p. 184
VB1.28	 	20 ... 28 kW		p. 184
VB1.30	 	22 ... 30 kW		p. 184
VB1.35	 	25 ... 35 kW		p. 184



























0 10 20 30 40 50 kW

TWO STAGES PWM / Low NO_x, Blue Flame

VB2.38 VD	 	22 ... 38 kW		p. 186
VB2.45 VD	 	25 ... 45 kW		p. 186
VB2.54 VD	 	32 ... 54 kW		p. 186
VB2.66 VD	 	40 ... 66 kW		p. 186
VB2.77 VD	 	45 ... 77 kW		p. 188
VB2.85 VD	 	48 ... 85 kW		p. 188
VB2.95 VD	 	52 ... 95 kW		p. 188







0 20 40 60 80 100 kW

TWO STAGES / Low NO_x, Blue Flame

VB30.120 D	 	50 ... 120 kW		p. 190
VB30.190 D	 	68 ... 195 kW		p. 190
VB30.230 D	 	125 ... 240 kW		p. 190
VB35.320 D	 	120 ... 330 kW		p. 192
VB35.370 D	 	140 ... 375 kW		p. 192
VB40.420 D	 	135 ... 430 kW		p. 194
VB40.460 D	 	140 ... 470 kW		p. 194
VB40.590 D	 	230 ... 600 kW		p. 194
VB45.810 D	 	290 ... 825 kW		p. 194







0 200 400 600 800 1000 kW

TWO STAGE PROGRESSIVE/MODULATING ELECTRONIC / ULTRA Low NO_x















EK EVO 4.800 L-EOT		260 ... 870 kW		p. 196
EK EVO 4.1000 L-EOT		260 ... 1100 kW		p. 196
EK EVO 5.1400 L-EOT		500 ... 1450 kW		p. 196

0 400 800 1200 1600 2000 kW































ONE STAGE with pre-heater

VL1.40 P	 	18 ... 40 kW		p. 198
VL1.55 P	 	30 ... 55 kW		p. 198



















ONE STAGE

VL1.42	 	20 ... 42 kW		p. 198
VL1.55	 	30 ... 55 kW		p. 198
VL1.105	 	45 ... 105 kW		p. 198
VL2.140	 	80 ... 140 kW		p. 200
VL2.200	 	130 ... 200 kW		p. 200



TWO STAGES

VL2.120 D	 	60 ... 120 kW		p. 202
VL2.160 D	 	80 ... 160 kW		p. 202
VL2.210 D	 	100 ... 210 kW		p. 202
VL3.290 D	 	130 ... 290 kW		p. 204
VL3.360 D	 	170 ... 360 kW		p. 204
VL4.440 D	 	180 ... 440 kW		p. 204
VL4.460 D	 	180 ... 460 kW		p. 206
VL4.610 D	 	195 ... 610 kW		p. 206
VL5.950 D	 	260 ... 950 kW		p. 208
VL5.1200 D	 	400 ... 1186 kW		p. 208







THREE STAGES

VL4.460 DP	 	180 ... 460 kW		p. 210
VL4.610 DP	 	195 ... 610 kW		p. 210
VL5.950 DP	 	260 ... 950 kW		p. 212
VL5.1200 DP	 	400 ... 1186 kW		p. 212
VL6.1600 DP	 	320 ... 1600 kW		p. 214
VL6.2100 DP	 	400 ... 2080 kW		p. 214

ONE STAGE with pre-heater / Low NOx

VL1.40 BIO	 	16 ... 40 kW		p. 216
------------	---	--------------	--	--------

ONE STAGE / Low NOx

VL1.70 BIO	 	35 ... 70 kW		p. 216
VL1.100 BIO	 	60 ... 100 kW		p. 216

Modulation kit	p. 218
O₂/CO Trim	p. 220
Kit LCM for BT3xx	p. 221
Communication modules	p. 221
Display	p. 221
Remote software	p. 221
MDE2 System	p. 221
Cable for 0-10V load input	p. 221
Front boiler flange	p. 221
Sound proofing box	p. 222
External air intake connection kit	p. 222
External valve connection kit	p. 222
Maximum gas pressure switch	p. 222
Gas and air manometer with push button	p. 222
Gas filter	p. 222
Antivibration coupling - Compensator	p. 223
Ball valve	p. 223
Kit Variatron	p. 223
Kit remote reset	p. 223
Kit additional oil safety valve	p. 223
"Flame on" digital output	p. 223

VG1.40 E / VG1.55 E / VG1.105 E

15 ... 105 kW

One stage

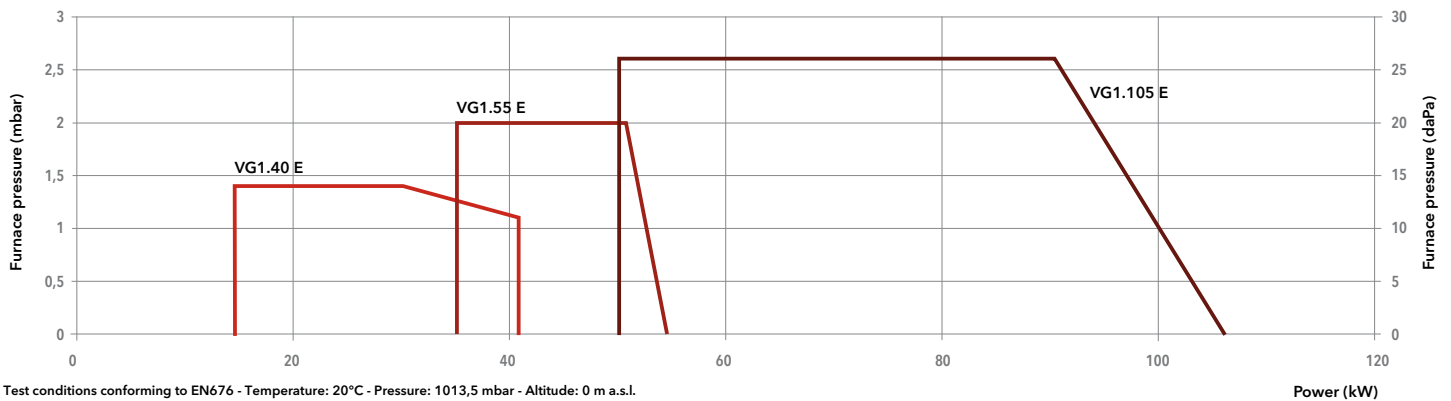

- **Fuels:** natural gas (G20/G25, $H_u = 8,83...10,35 \text{ kWh/m}^3$); LPG (G31, $H_u = 25,89 \text{ kWh/m}^3$)
- **Emissions:** $\text{NO}_x < 56 \text{ mg/kWh}$ (GCV), burners compliant with ErP Directive
- **Protection level:** IP 21

TECHNICAL DATA

Model	VG1.40 E /TC		VG1.55 E /TC		VG1.105 E /TC			
Operation range	15 - 41 kW		35 - 55 kW		50 - 105 kW			
Gas pressure	20 - 100 mbar		20 - 100 mbar		20 - 360 mbar			
Control box / flame detection	TCG1... / ionization		TCG1... / ionization		TCG1... / ionization			
Fan motor	230 V - 50 Hz - 85 W		230 V - 50 Hz - 85 W		230 V - 50 Hz - 85 W			
Electrical consumption (min/max/stand-by)	119 W / 137 W / 3 W		129 W / 131 W / 3 W		196 W / 212 W / 3 W			
Acoustic level (LpA)	55 dB(A)		55 dB(A)		61 dB(A)			
CE certificate	0476 CT 2423		0476 CT 2423		0476 CT 2423			
Head length	KN	KL	KN	KL	KN	KL		
Complete burner code	VR4625 MB-DLE 407	h3/8"-Rp1/2"/TC d3/4"-Rp3/4"/TC	3866346	3836506	3836347	3836517	- 3836348	- 3836518

OTHER AVAILABLE VERSIONS
 60 60 Hz version

 Vent Versions for continuous ventilation and post-ventilation
SCOPE OF SUPPLY

The burner is delivered in its package complete with:

- 1 gas connection flange
- 1 compact gas train with gas filter; the gas filter is built-in for threaded valves (up to 2") and separated for flanged ones (DN65/80/100)
- 1 burner flange with insulation
- 1 bag containing installation fittings
- 1 bag containing technical documentation (instruction manual, technical data, electrical diagram, exploded view and spare parts list)



DIMENSIONS (mm)

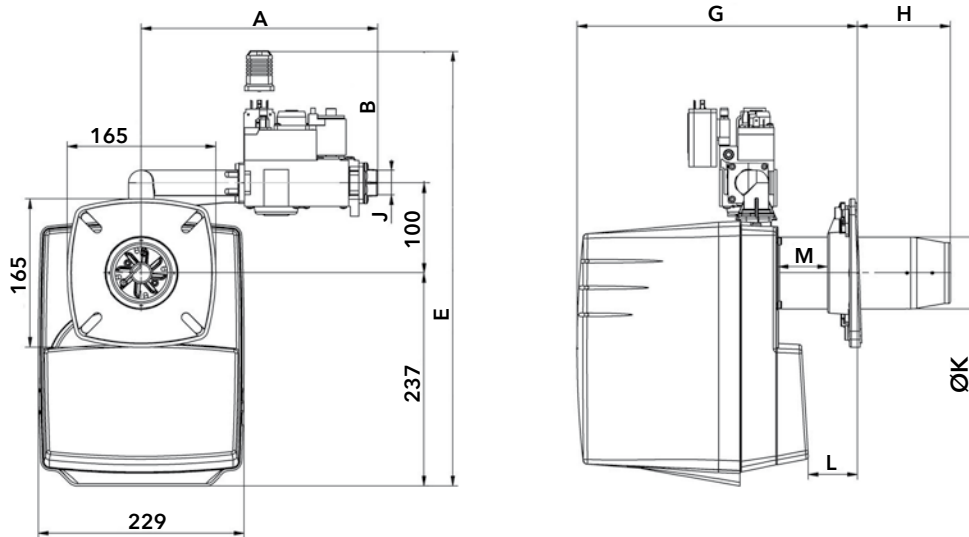

Model	A	B	E	G		H		J	Ø K	L		M
				KN	KL	KN	KL			min	max	
VG1.40/55 E	263	147	484	297...337	297...387	70...110	70...200	Rp1/2"	80	21	61	48
VG1.105 E	282	140	477	300...355	300...390	70...138	70...228	Rp3/4"	90	15	83	52

Connecting flange

Model	Øa (mm)	b (mm)	c	d
VG1.40/55 E	85-104	150-170	M8	45°
VG1.105 E	95-104	150-170	M8	45°

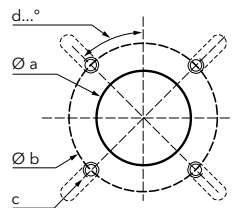

PACKAGING

The burner is delivered in a single package containing all the components

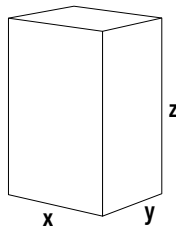

Burner	Dimensions (mm)			Gross weight (kg)
	X	Y	Z	
VG1.40 E	300	260	650	12
VG1.55 E	300	260	650	12
VG1.105 E	300	260	650	12

VG2.140 E / VG2.205 E80 ... 205 kW
One stage

- **Fuels:** natural gas (G20/G25, $H_u = 8,83...10,35 \text{ kWh/m}^3$); LPG (G31, $H_u = 25,89 \text{ kWh/m}^3$)
- **Emissions:** $\text{NO}_x < 56 \text{ mg/kWh (GCV)}$, burners compliant with ErP Directive
- **Protection level:** IP 21

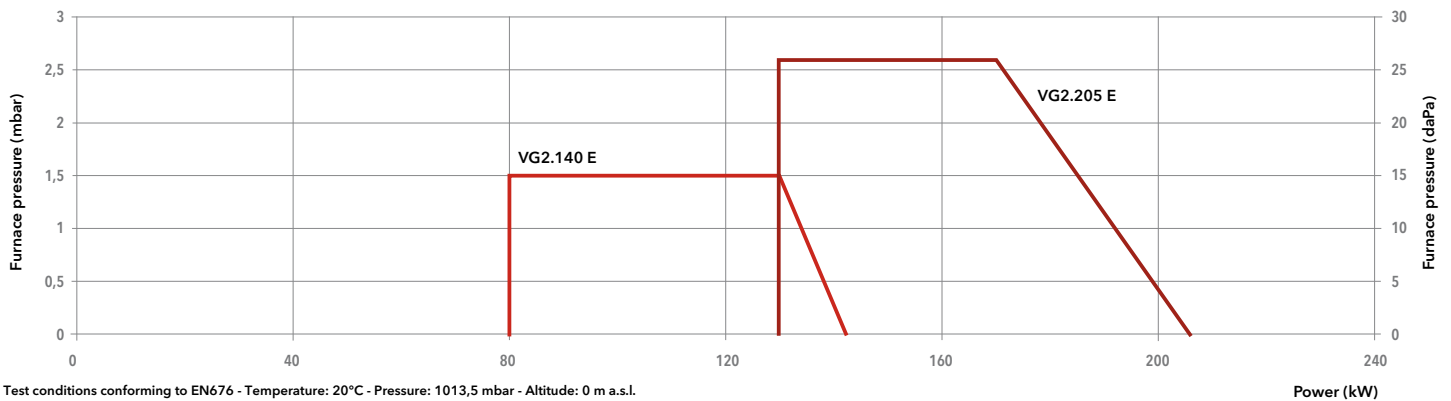
TECHNICAL DATA

Model	VG2.140 E		VG2.205 E	
Operation range	80 - 140 kW		130 - 205 kW	
Gas pressure	20 - 360 mbar		20 - 360 mbar	
Control box / flame detection	TCG1... / ionization		TCG1... / ionization	
Fan motor	230 V - 50 Hz - 100 W		230 V - 50 Hz - 130 W	
Electrical consumption (max/min/stand-by)	270 W / 230 W / 3 W		302 W / 267 W / 3 W	
Acoustic level (LpA)	62 dB(A)		65 dB(A)	
CE certificate	0476 CT 2423		0476 CT 2423	
Head length	KN	KL	KN	KL
Complete burner code	MB-DLE 412 MB-DLE 407	d1"1/4-Rp1"1/4 d3/4"-Rp3/4"	- 3836349	- 3836350
			3836351 3836353	3836352 3836354

OTHER AVAILABLE VERSIONS

- 60 60 Hz version
- Vent Versions for continuous ventilation and post-ventilation

SCOPE OF SUPPLY

The burner is delivered in its package complete with:

- 1 gas connection flange
- 1 compact gas train with gas filter; the gas filter is built-in for threaded valves (up to 2") and separated for flanged ones (DN65/80/100)
- 1 burner flange with insulation
- 1 bag containing installation fittings
- 1 bag containing technical documentation (instruction manual, technical data, electrical diagram, exploded view and spare parts list)



DIMENSIONS (mm)

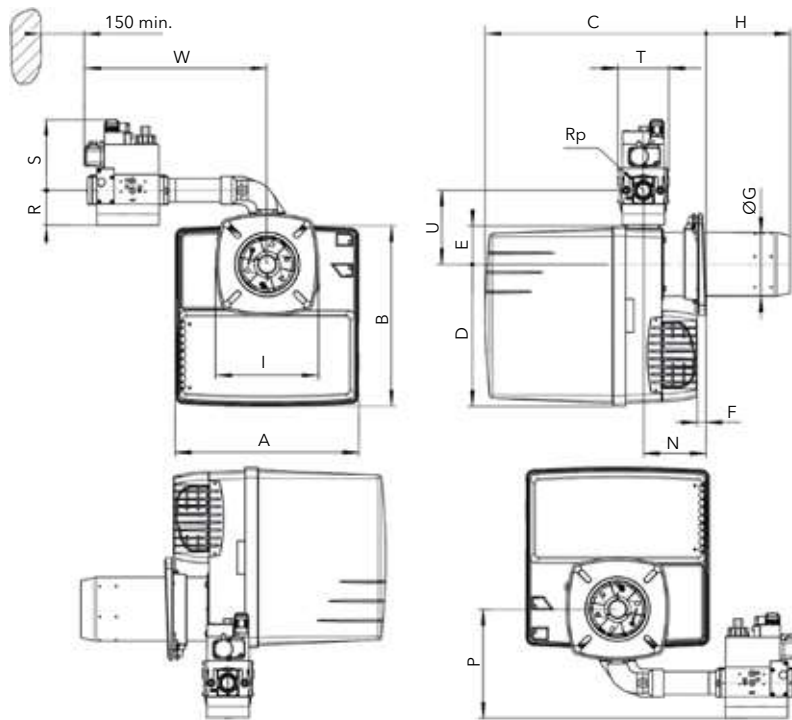

Model	Gas train	A	B	C		D	E	F min	ØG	H		I	N min	P	Rp	R	S	T	U	W
				KN	KL					KN	KL									
VG2.140	d3/4"-Rp3/4"	331	325	398...518	398...638	256	69	15	115	30...150	30...270	185	113	179	3/4"	70	140	120	133	345
VG2.205	d3/4"-Rp3/4"	331	325	398...518	398...638	256	69	15	125	30...150	30...270	185	113	179	3/4"	70	140	120	133	345
VG2.205	d1"1/4-Rp1"1/4	331	325	398...518	398...638	256	69	15	125	30...150	30...270	185	113	188	1"1/4	80	160	145	133	380

Connecting flange

Model	Øa (mm)	b (mm)	c	d
VG2.140	120-135	150-185	M8	45°
VG2.205	130-145	160-185	M8	45°

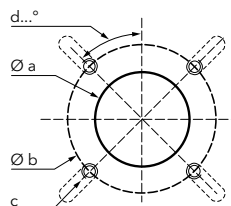

PACKAGING

The burner is delivered in a single package containing all the components

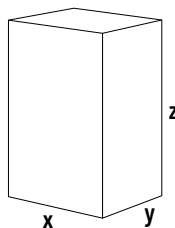

Burner	Dimensions (mm)			Gross weight (kg)
	X	Y	Z	
VG2.140	400	400	760	25
VG2.205	400	400	760	25

VG1.105 D E

37 ... 105 kW
Two stages

- **Fuels:** natural gas (G20/G25, $H_u = 8,83 \dots 10,35 \text{ kWh/m}^3$);
LPG (G31, $H_u = 25,89 \text{ kWh/m}^3$)
- **Emissions:** $\text{NO}_x < 56 \text{ mg/kWh}$ (GCV), burners compliant with ErP Directive
- **Protection level:** IP 21



TECHNICAL DATA

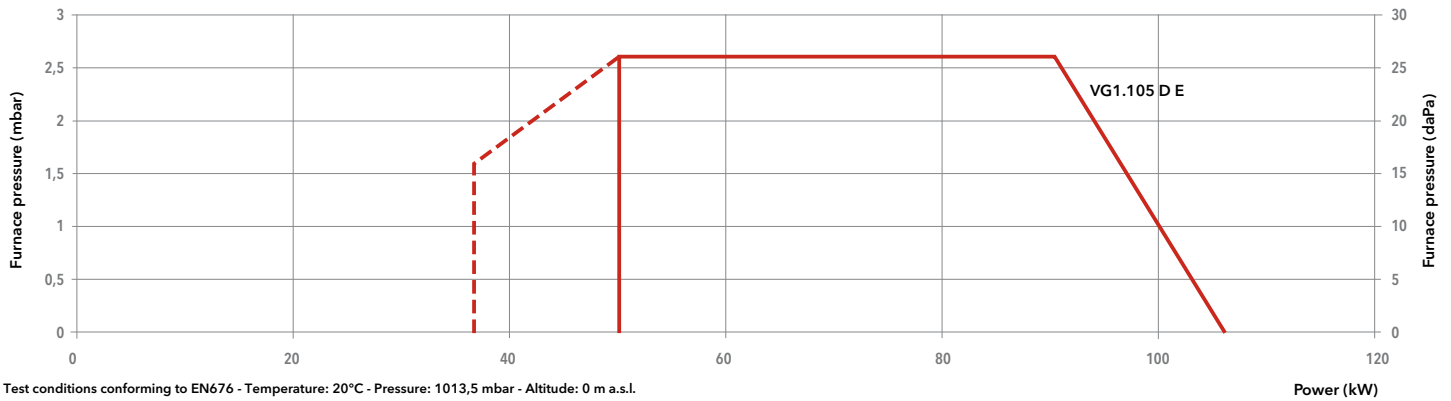

Model	VG1.105 D	
Operation range	(37) 50 - 105 kW	
Gas pressure	20 - 360 mbar	
Flame detection	Ionization	
Fan motor	230 V - 50 Hz - 85 W	
Electrical consumption (max/min/stand-by)	205 W / 200 W / 3 W	
Acoustic level (LpA)	60,5 dB(A)	
CE certificate	0476 CT 2423	
Head length	KN	KL
Complete burner code	MB-ZRDLE 407 d3/4"-Rp3/4" 3836355	3836519

OTHER AVAILABLE VERSIONS

- 60 60 Hz version
- V_{ent} Versions for continuous ventilation and post-ventilation

SCOPE OF SUPPLY

The burner is delivered in its package complete with:

- 1 gas connection flange
- 1 compact gas train with gas filter; the gas filter is built-in for threaded valves (up to 2") and separated for flanged ones (DN65/80/100)
- 1 burner flange with insulation
- 1 bag containing installation fittings
- 1 bag containing technical documentation (instruction manual, technical data, electrical diagram, exploded view and spare parts list)



DIMENSIONS (mm)

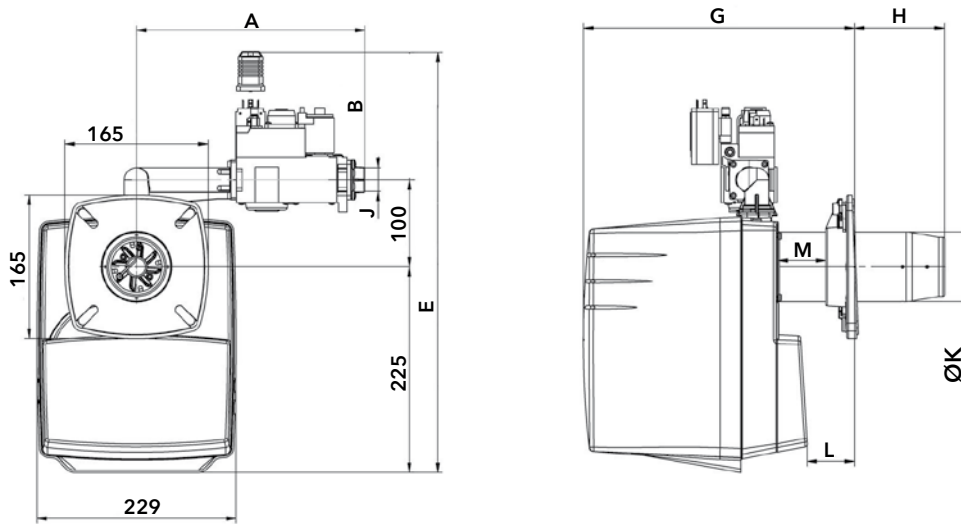

A	B	E	G		H		J	ØK	L		M
			KN	KL	KN	KL			min	max	
290	310	535	300...355	300...390	70...138	70...228	Rp3/4"	90	15	83	52

Connecting flange

Øa (mm)	b (mm)	c	d
95-104	150-170	M8	45°

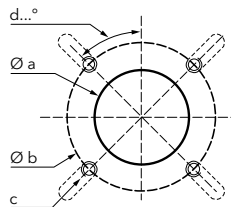

PACKAGING

The burner is delivered in a single package containing all the components

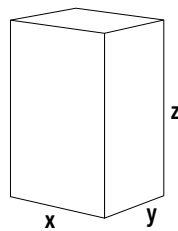

Dimensions (mm)			Gross weight (kg)
X	Y	Z	
300	260	650	12

VG2.90 D E / VG2.120 D E / VG2.160 D E / VG2.205 D E

20 ... 205 kW
Two stages



- **Fuels:** natural gas (G20/G25, $H_u = 8,83 \dots 10,35 \text{ kWh/m}^3$); LPG (G31, $H_u = 25,89 \text{ kWh/m}^3$)
- **Emissions:** $\text{NO}_x < 56 \text{ mg/kWh}$ (GCV), burners compliant with ErP Directive
- **Protection level:** IP 21

TECHNICAL DATA

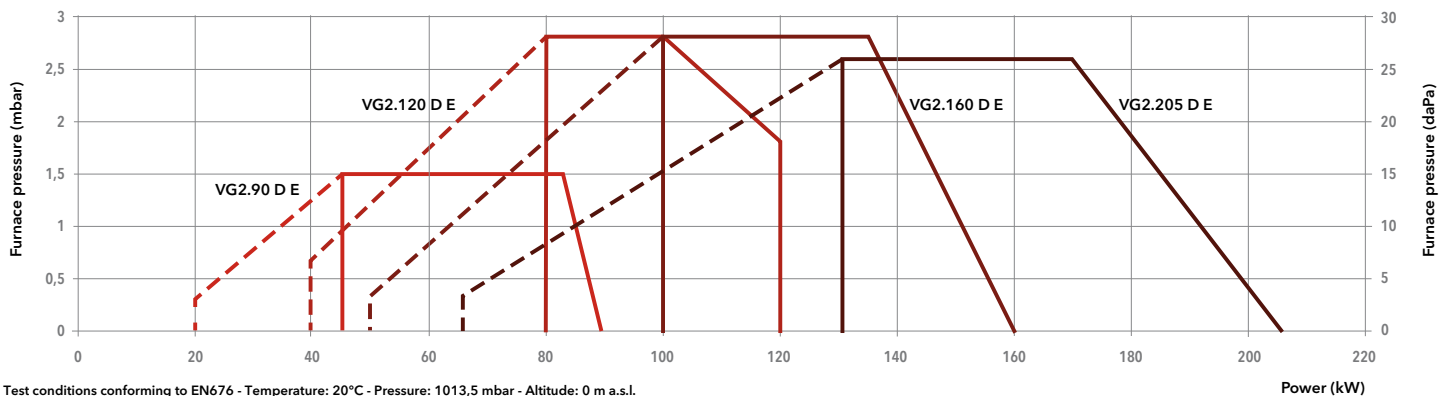

Model	VG2.90 D E		VG2.120 D E		VG2.160 D E		VG2.205 D E	
Operation range	(20) 45 - 90 kW		(40) 80 - 120 kW		(50) 100 - 160 kW		(60) 130 - 205 kW	
Gas pressure	20 - 360 mbar		20 - 360 mbar		20 - 360 mbar		20 - 360 mbar	
Control box / flame detection	TCG2... / ionization		TCG2... / ionization		TCG2... / ionization		TCG2... / ionization	
Fan motor	230 V - 50 Hz - 75 W		230 V - 50 Hz - 100 W		230 V - 50 Hz - 100 W		230 V - 50 Hz - 130 W	
Electrical consumption (min/max/stand-by)	140 W / 145 W / 4 W		239 W / 358 W / 4 W		285 W / 293 W / 4 W		302 W / 267 W / 4 W	
Acoustic level (LpA)	64 dB(A)		64 dB(A)		64 dB(A)		64 dB(A)	
CE certificate	0476 DN 1270		0476 CT 2423		0476 CT 2423		0476 CT 2423	
Head length	KN	KL	KN	KL	KN	KL	KN	KL
Complete burner code	MB-ZRDLE 412 d1"1/4-Rp1"1/4	-	-	-	-	-	3836360	3836361
	MB-ZRDLE 407 d3/4"-Rp3/4"	3837230	3837231	3836356	3836357	3836358	3836359	3836362
	MB-ZRDLE 405 d3/4"-Rp3/4"	3837228	3837229	-	-	-	-	3836363

OTHER AVAILABLE VERSIONS

- 60 60 Hz version
- Ver Versions for continuous ventilation and post-ventilation

SCOPE OF SUPPLY

The burner is delivered in its package complete with:

- 1 gas connection flange
- 1 compact gas train with gas filter; the gas filter is built-in for threaded valves (up to 2") and separated for flanged ones (DN65/80/100)
- 1 burner flange with insulation
- 1 bag containing installation fittings
- 1 bag containing technical documentation (instruction manual, technical data, electrical diagram, exploded view and spare parts list)



DIMENSIONS (mm)

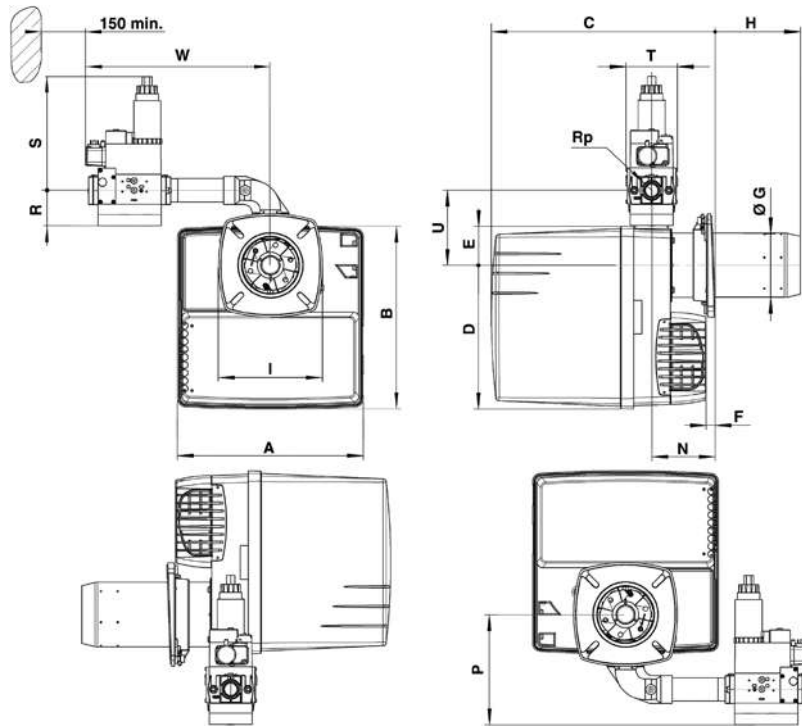

Model	Gas train	A	B	C		D	E	F min	ØG	H		I	N min	P	Rp	R	S	T	U	W
				KN	KL					KN	KL									
VG2.90	d3/4"-Rp3/4"	331	325	398...480	398...600	256	69	15	100	70...150	70...270	185	105	179	3/4"	70	160	120	133	345
VG2.120	d3/4"-Rp3/4"	331	325	398...518	398...638	256	69	15	115	30...150	30...270	185	113	179	3/4"	46	210	120	133	330
VG2.160	d3/4"-Rp3/4"	331	325	398...518	398...638	256	69	15	115	30...150	30...270	185	113	179	3/4"	46	210	120	133	330
VG2.205	d3/4"-Rp3/4"	331	325	398...518	398...638	256	69	15	125	30...150	30...270	185	113	179	3/4"	46	210	120	133	330
	d1"1/4-Rp1"1/4	331	325	398...518	398...638	256	69	15	125	30...150	30...270	185	113	188	1"1/4	55	260	145	133	360

Connecting flange

Model	Øa (mm)	b (mm)	c	d
VG2.90...160	120-135	150-185	M8	45°
VG2.205	130-145	160-185	M8	45°

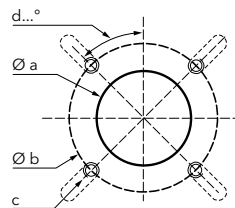

PACKAGING

The burner is delivered in a single package containing all the components

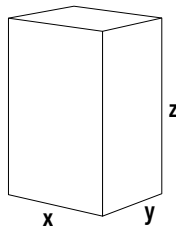

Burner	Dimensions (mm)			Gross weight (kg)
	X	Y	Z	
VG2.90	400	400	760	26
VG2.120	400	400	760	26
VG2.160	400	400	760	26
VG2.205	400	400	760	26

PRESSURE LOSS [BURNER HEAD + GAS TRAIN] (mbar)

VG2.90 D E

Burner output (kW)	Natural gas G20 Hi = 10,35 kWh/m ³		Natural gas G25 Hi = 8,83 kWh/m ³	
	MB-ZRDLE 405 / d3/4"-Rp3/4"	MB-ZRDLE 407 / d3/4"-Rp3/4"	MB-ZRDLE 405 / d3/4"-Rp3/4"	MB-ZRDLE 407 / d3/4"-Rp3/4"
30	3,5	3,5	4	4
50	7,2	6,5	9,5	8,2
70	12	10	16,8	13,7
90	17,9	14	26,3	20,5

Natural gas G20

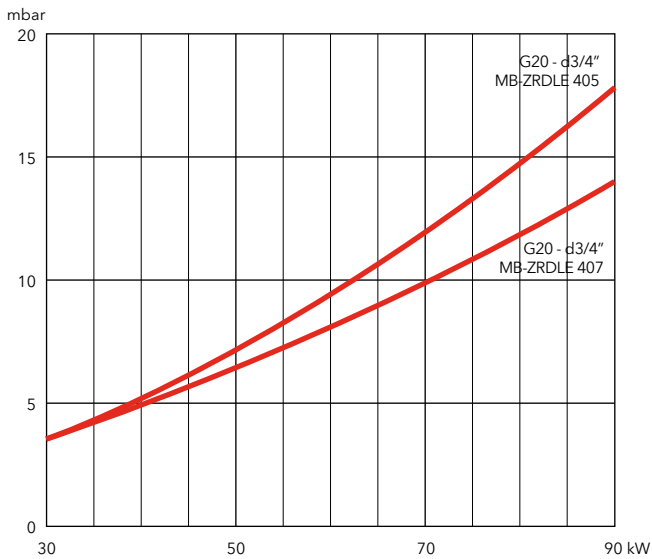

Natural gas G25

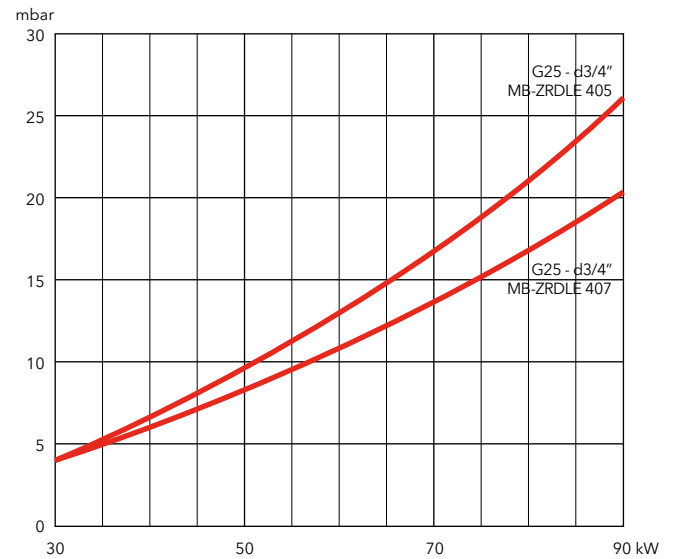



PRESSURE LOSS [BURNER HEAD + GAS TRAIN] (mbar)

VG2.90 D E

Burner output (kW)	LPG G31 Hi = 25,89 kWh/m ³	
	MB-ZRDLE 405 / d3/4"-Rp3/4"	MB-ZRDLE 407 / d3/4"-Rp3/4"
30	3,2	3,2
50	6	5,6
70	9,1	8,2
90	12,7	10,9

LPG

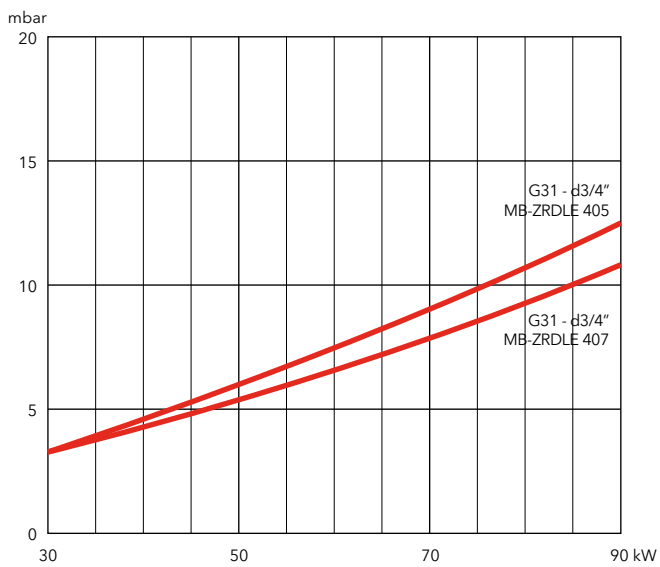

VG3.290 D E / VG3.350 D E

95 ... 350 kW
Two stages

- **Fuels:** natural gas (G20/G25, $H_u = 8,83...10,35 \text{ kWh/m}^3$); LPG (G31, $H_u = 25,89 \text{ kWh/m}^3$)
- **Emissions:** $\text{NO}_x < 56 \text{ mg/kWh}$ (GCV), burners compliant with ErP Directive
- **Protection level:** IP 21



TECHNICAL DATA

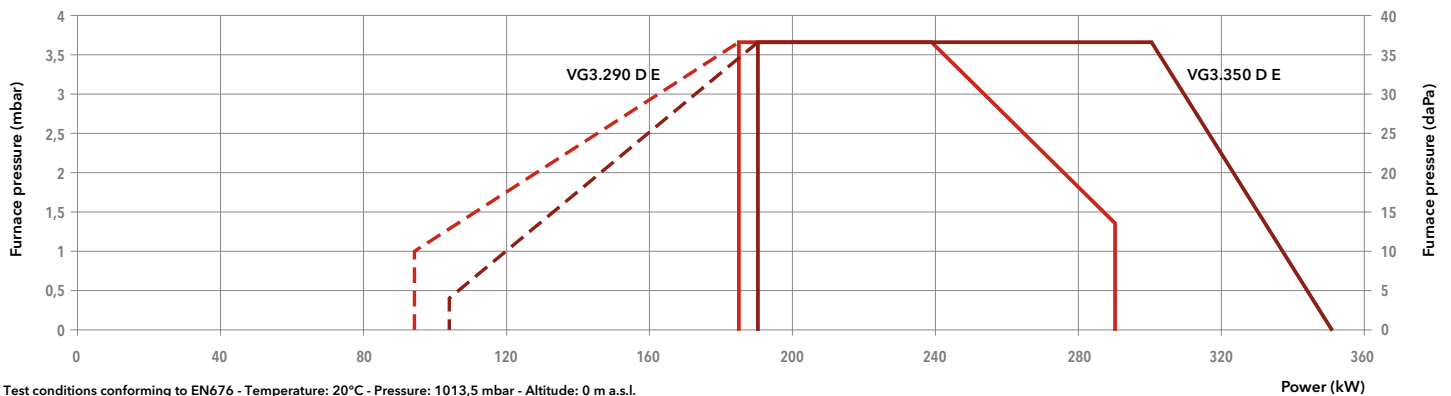

Model	VG3.290 D E		VG3.350 D E	
Operation range	(95) 185 - 290 kW		(105) 190 - 350 kW	
Gas pressure	20 - 360 mbar		20 - 360 mbar	
Control box / flame detection	TCG2... / ionization		TCG2... / ionization	
Fan motor	230 V - 50 Hz - 250 W		230 V - 50 Hz - 300 W	
Electrical consumption (max/min/stand-by)	465 W / 441 W / 4 W		583 W / 583 W / 4 W	
Acoustic level (LpA)	67 dB(A)		69 dB(A)	
CE certificate	0476 CT 2423		0476 CT 2423	
Head length	KN	KL	KN	KL
Complete burner code	MB-ZRDLE 420 d1"1/2-Rp2"	-	3836382	3836383
	MB-ZRDLE 412 d1"1/4-Rp1"1/4	3836378	3836384	3836385
	MB-ZRDLE 407 d3/4"-Rp3/4"	3836380	3836381	3836386

OTHER AVAILABLE VERSIONS

- 60 60 Hz version
- TC Version with tightness control
- V_{vent} Versions for continuous ventilation and post-ventilation

SCOPE OF SUPPLY

The burner is delivered in its package complete with:

- 1 burner head with flange seal and securing screws
- 1 compact gas train with gas filter; the gas filter is built-in for threaded valves (up to 2") and separated for flanged ones (DN65/80/100)
- 1 bag containing installation fittings
- 1 bag containing technical documentation (instruction manual, technical data, electrical diagram, exploded view and spare parts list)



DIMENSIONS (mm)

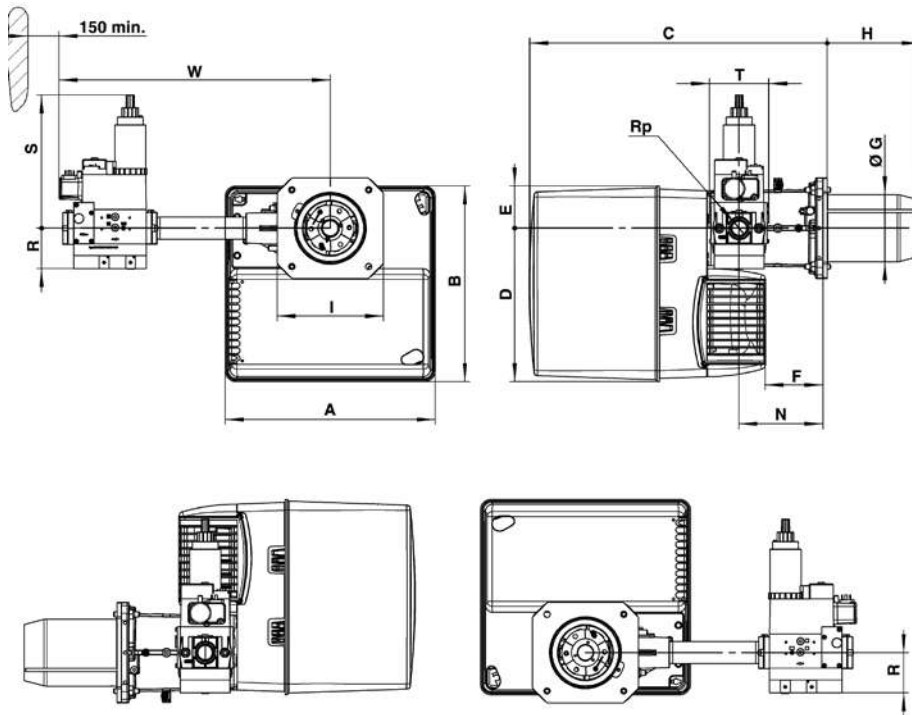

Gas train model	A	B	C	D	E	F	ØG	H		I	N	Rp	R	S	T	W
								KN	KL							
d1"1/2-Rp2"	406	379	576	297	82	120	130	180	320	195x205	170	2"	80	330	100	603
d1"1/4-Rp1"1/4	406	379	576	297	82	120	130	180	320	195x205	170	1"1/4	55	260	145	526
d3/4"-Rp3/4"	406	379	576	297	82	120	130	180	320	195x205	170	3/4"	46	210	120	479

Connecting flange

Øa (mm)	b (mm)	c	d
155-190	175-220	M10	45°

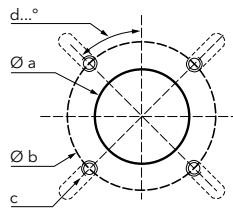

PACKAGING

The burner is delivered on a pallet in three packages containing:

- burner housing
- combustion head
- gas train and filter

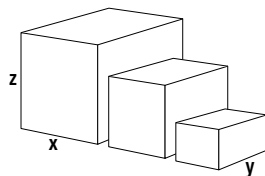

Component		Dimensions (mm)			Gross weight (kg)
		X	Y	Z	
Burner body	VG3.290 D E	440	400	520	21
	VG3.350 D E	440	400	520	21
Combustion head	KN	650	210	260	6
	KL	650	210	260	6
Gas train	d1"1/2-Rp2"	600	400	240	14
	d1"1/4-Rp1"1/4	440	320	240	10
	d3/4"-Rp3/4"	440	320	240	7

VG3.290 D E / VG3.350 D E

95 ... 350 kW
Two stages

PRESSURE LOSS [BURNER HEAD + GAS TRAIN] (mbar)

VG3.290 D E

Burner output (kW)	Natural gas G20 Hi = 10,35 kWh/m ³		Natural gas G25 Hi = 8,83 kWh/m ³		LPG G31 Hi = 25,89 kWh/m ³	
	d3/4"-Rp3/4"	d1"1/4-Rp1"1/4	d3/4"-Rp3/4"	d1"1/4-Rp1"1/4	d3/4"-Rp3/4"	d1"1/4-Rp1"1/4
190	22	10	29	12	13	7
210	24	10	33	13	14	7
230	27	11	38	15	15	7
250	31	12	43	16	16	7
270	36	14	49	18	18	8
290	41	15	56	20	21	9

Natural gas G20

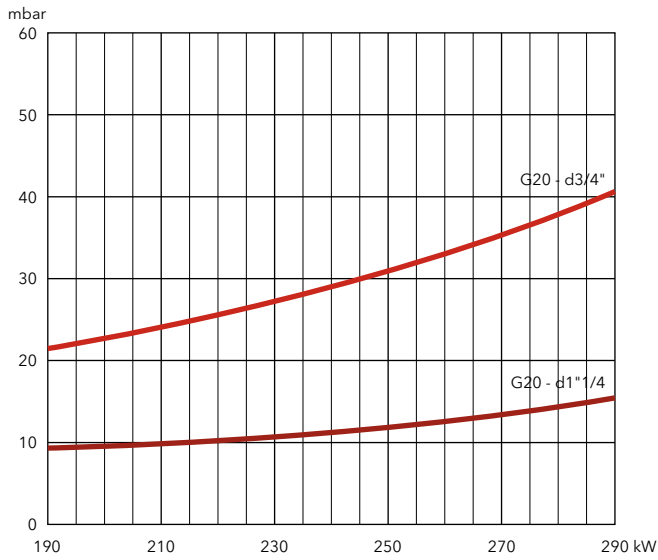

Natural gas G25

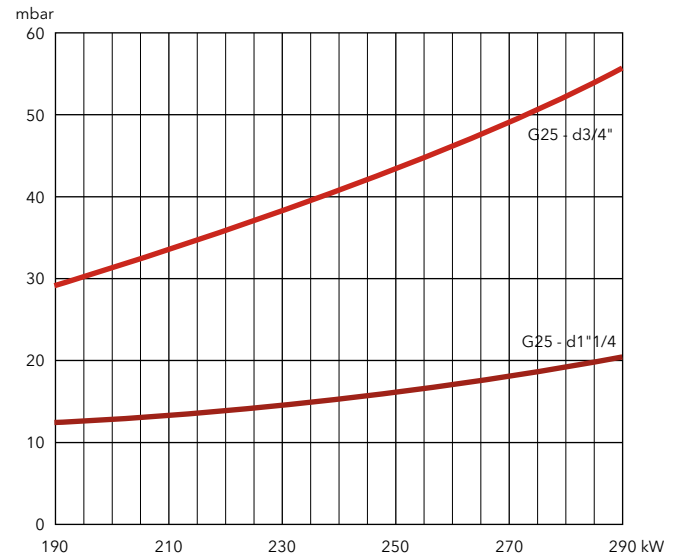

LPG

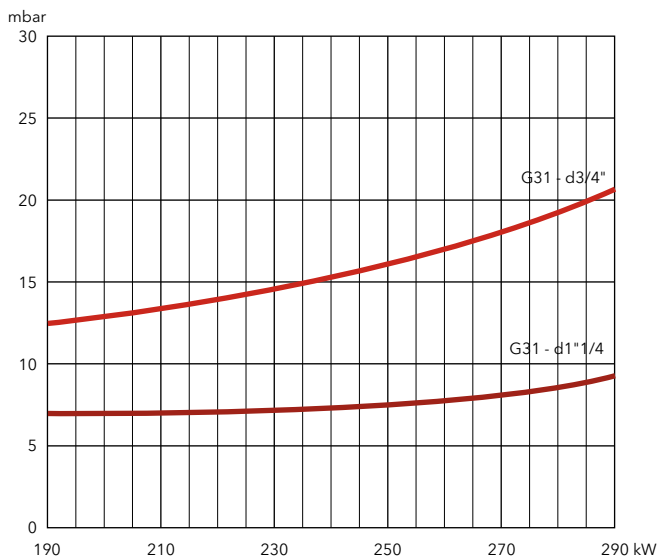



PRESSURE LOSS [BURNER HEAD + GAS TRAIN] (mbar)

VG3.350 D E

Burner output (kW)	Natural gas G20 Hi = 10,35 kWh/m ³		Natural gas G25 Hi = 8,83 kWh/m ³			LPG G31 Hi = 25,89 kWh/m ³
	d3/4"-Rp3/4"	d1"1/4-Rp1"1/4	d3/4"-Rp3/4"	d1"1/4-Rp1"1/4	d1"1/2-Rp2"	d3/4"-Rp3/4"
190	18	7	27	10	8	10
230	25	9	38	14	9	14
270	33	12	49	18	12	18
310	43	14	62	23	14	23
350	53	18	77	28	19	28

Natural gas G20

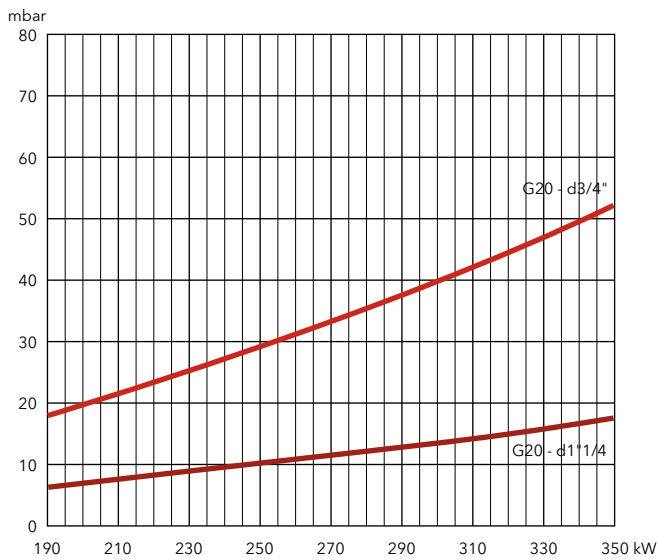

Natural gas G25

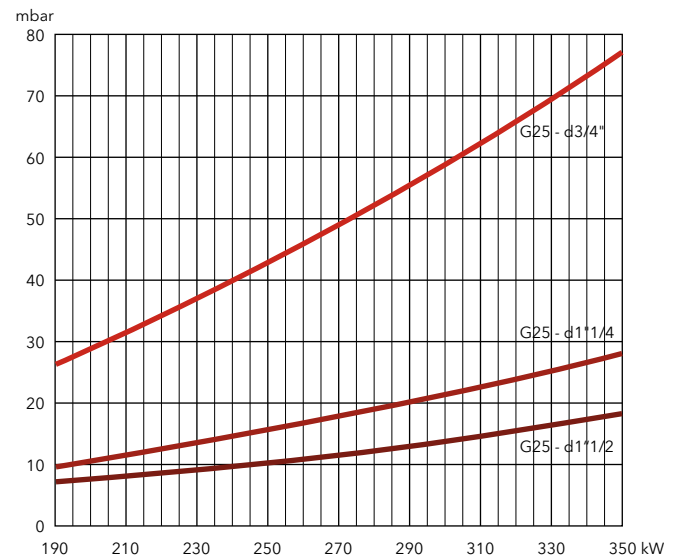

LPG

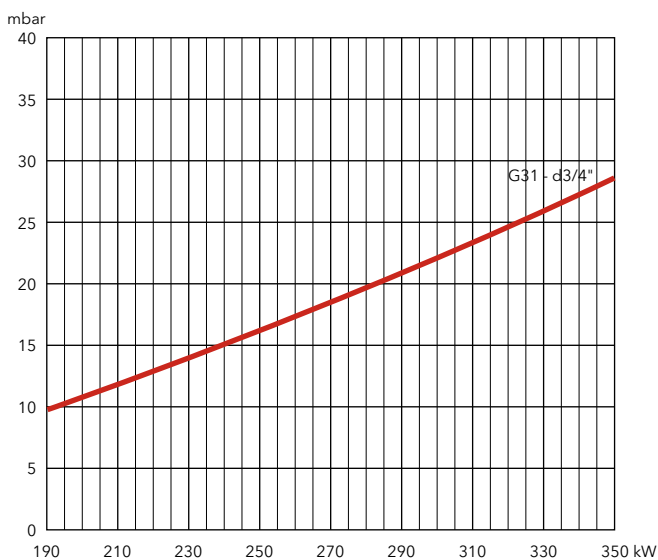

VG4.440 D E

110 ... 440 kW
Two stages

- **Fuels:** natural gas (G20/G25, $H_u = 8,83...10,35 \text{ kWh/m}^3$); LPG (G31, $H_u = 25,89 \text{ kWh/m}^3$)
- **Emissions:** $\text{NO}_x < 56 \text{ mg/kWh}$ (GCV), burners compliant with ErP Directive
- **Protection level:** IP 21



TECHNICAL DATA

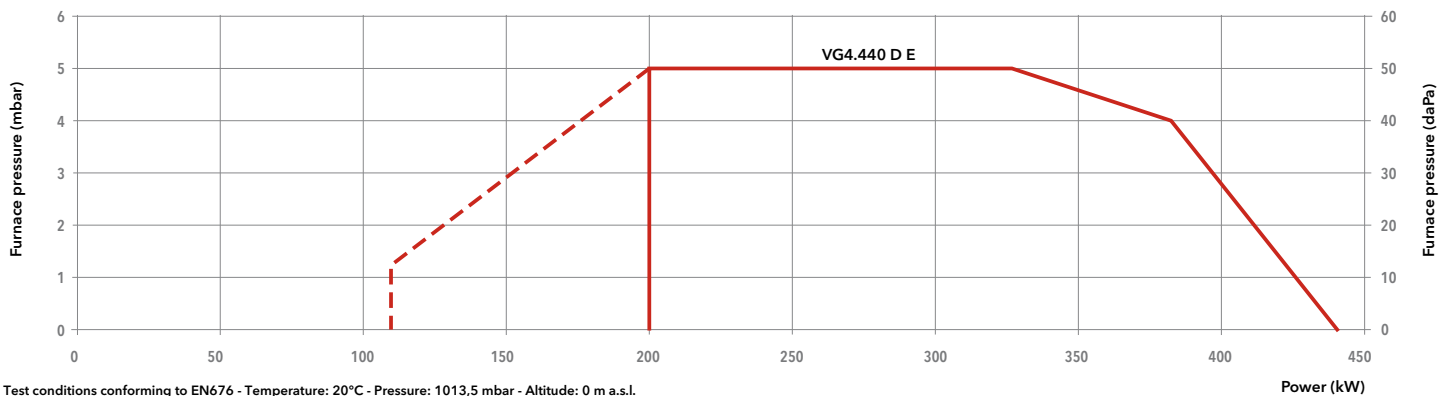

Model		VG4.440 D E	
Operation range		(110) 200 - 440 kW	
Gas pressure		20 - 360 mbar	
Control box / flame detection		TCG2... / ionization	
Fan motor		230 V - 50 Hz - 420 W	
Electrical consumption (max/min/stand-by)		606 W / 569 W / 4 W	
Acoustic level (LpA)		70 dB(A)	
CE certificate		0476 CT 2423	
Head length		KN	KL
Complete burner code	MB-ZRDLE 420 d1"1/2-Rp2"	3836398	3836399
	MB-ZRDLE 412 d1"1/4-Rp1"1/4"	3836400	3836401
	MB-ZRDLE 407 d3/4"-Rp3/4"	3836402	3836403

OTHER AVAILABLE VERSIONS

- 60 60 Hz version
- TC Version with tightness control
- V_{vent} Versions for continuous ventilation and post-ventilation

SCOPE OF SUPPLY

The burner is delivered in its package complete with:

- 1 burner head with flange seal and securing screws
- 1 compact gas train with gas filter; the gas filter is built-in for threaded valves (up to 2") and separated for flanged ones (DN65/80/100)
- 1 bag containing installation fittings
- 1 bag containing technical documentation (instruction manual, technical data, electrical diagram, exploded view and spare parts list)



DIMENSIONS (mm)

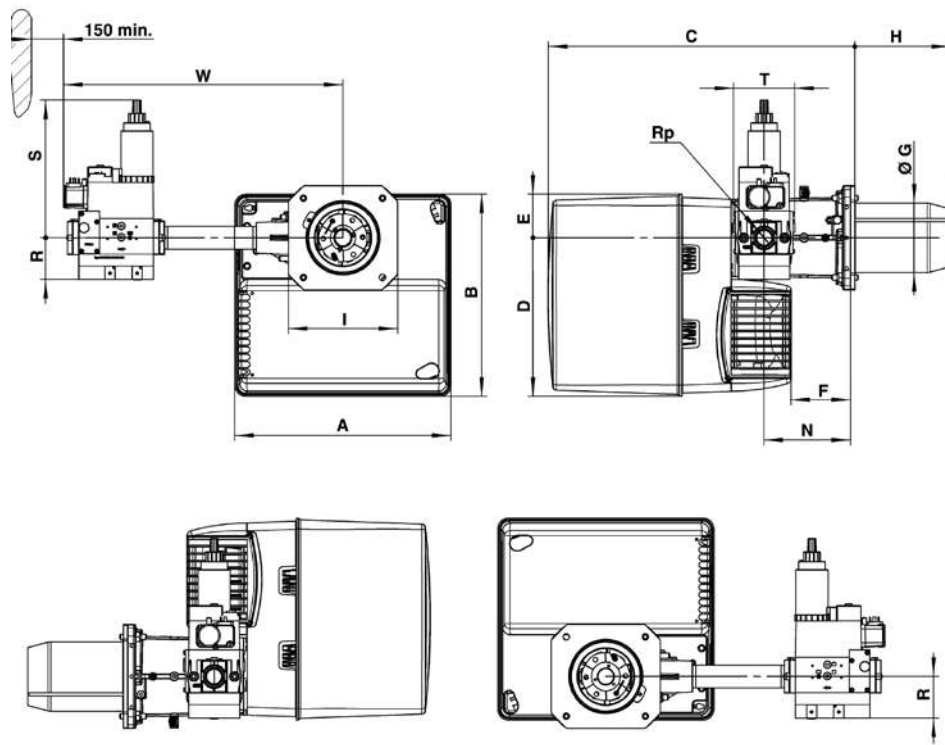

Gas train model	A	B	C	D	E	F	ØG	H		I	N	Rp	R	S	T	W
								KN	KL							
d1"1/2-Rp2"	465	475	640	377	97	149	157	212	352	245	195	2"	80	330	100	613
d1"1/4-Rp1"1/4	465	475	640	377	97	149	157	212	352	245	195	1"1/4	55	260	145	536
d3/4"-Rp3/4"	465	475	640	377	97	149	157	212	352	245	195	3/4"	46	210	120	489

Connecting flange

Øa (mm)	b (mm)	c	d
190-240	200-270	M10	45°

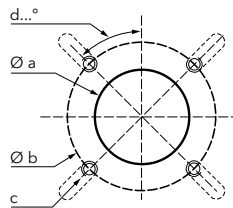

PACKAGING

The burner is delivered on a pallet in three packages containing:

- burner housing
- combustion head
- gas train and filter

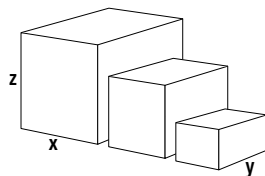

Component		Dimensions (mm)			Gross weight (kg)
		X	Y	Z	
Burner body	VG4.440 D E	490	490	590	28,7
	KN	750	260	295	8,9
Combustion head	KL	895	260	295	10,1
	d1"1/2-Rp2"	600	400	240	14
Gas train	d1"1/4-Rp1"1/4	440	320	240	10
	d3/4"-Rp3/4"	440	320	240	7

VG4.440 D E

110 ... 440 kW
Two stages

PRESSURE LOSS [BURNER HEAD + GAS TRAIN] (mbar)

VG4.440 D E

Burner output (kW)	Natural gas G20 Hi = 10,35 kWh/m ³			Natural gas G25 Hi = 8,83 kWh/m ³		
	d3/4"-Rp3/4"	d1"1/4-Rp1"1/4	d1"1/2-Rp2"	d3/4"-Rp3/4"	d1"1/4-Rp1"1/4	d1"1/2-Rp2"
240	27	9	6	39	13	9
280	35	12	6	50	16	10
320	43	14	7	62	20	11
360	53	17	9	76	24	14
400	64	20	11	91	29	17
440	76	24	13	107	34	19

Natural gas G20

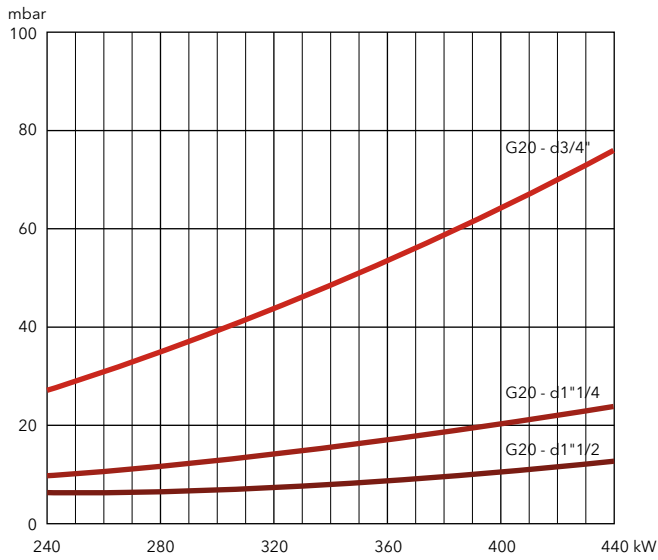

Natural gas G25

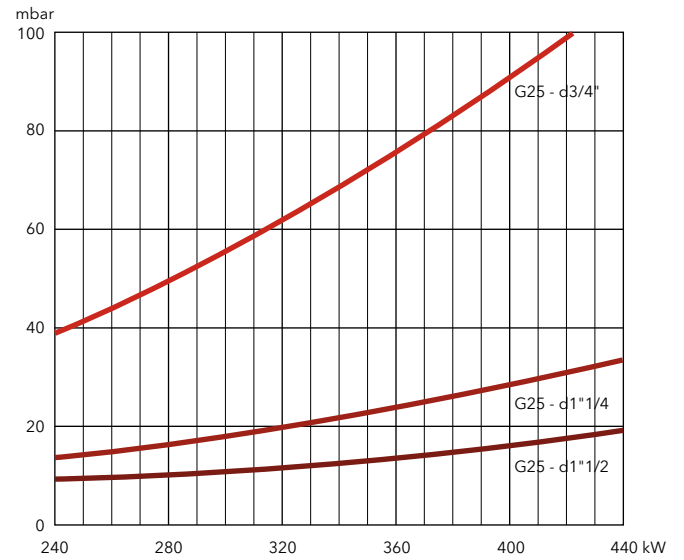



PRESSURE LOSS [BURNER HEAD + GAS TRAIN] (mbar)

VG4.440 D E

Burner output (kW)	LPG G31 Hi = 25,89 kWh/m ³	
	d3/4"-Rp3/4"	d1"1/4-Rp1"1/4
240	16	8
280	20	9
320	24	10
360	29	12
400	35	15
440	42	18

LPG

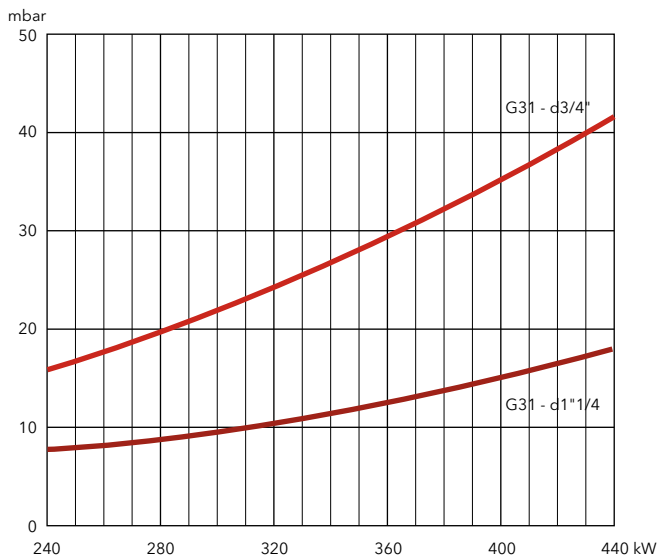

VG4.460 D

150 ... 460 kW
2 stages

- **Fuels:** natural gas, net calorific value 8,83...10,35 kWh/m³;
LPG, net calorific value 25,89 kWh/m³
- **Emissions:** NOx < 70 mg/kWh (NCV), Low NOx class 3 burners according to EN676
- **Protection level:** IP 41



TECHNICAL DATA

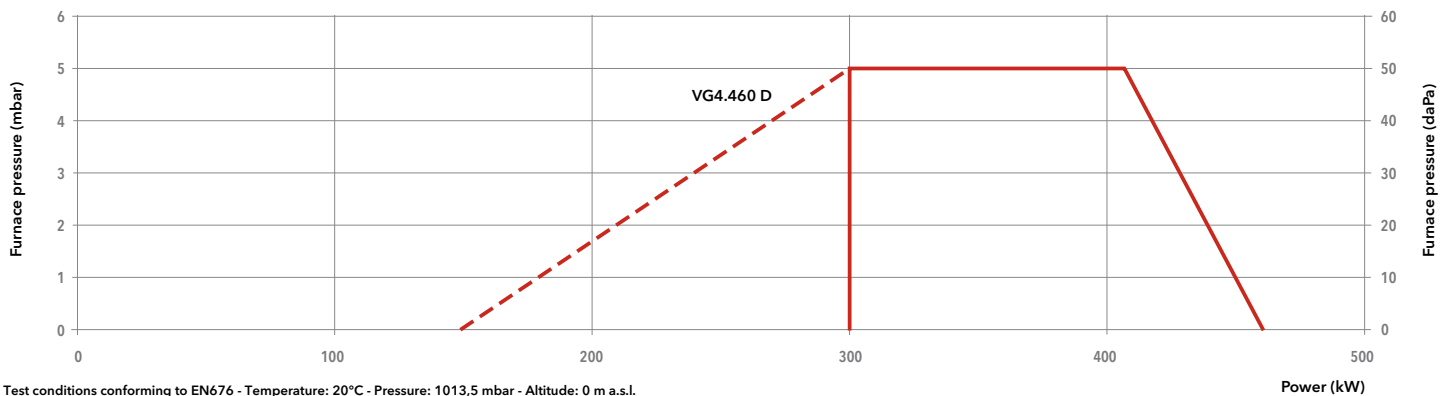

Model		VG 4.460 D	
Operation range		(150) 300 - 460 kW	
Gas pressure		20 - 300 mbar	
Control box / flame detection		TCG2... / ionization	
Fan motor		230 V - 50 Hz - 420 W	
Electrical consumption		595 W	
Acoustic level (LpA)		70 dB(A)	
CE certificate		1312 CL 5412	
Head length		KN	KL
Complete burner code	MB-ZRDLE 420 d1"1/2-Rp2"	3833399	3833400
	MB-ZRDLE 412 d1"1/4-Rp1"1/4"	3833401	3833402
	MB-ZRDLE 407 d3/4"-Rp3/4"	3833403	3833404

OTHER AVAILABLE VERSIONS

- 60 60 Hz version
- TC Version with tightness control
- V_{vent} Versions for continuous ventilation and post-ventilation

SCOPE OF SUPPLY

The burner is delivered in its package complete with:

- 1 burner head with flange seal and securing screws
- 1 compact gas train with gas filter
- 1 bag containing installation fittings
- 1 bag containing technical documentation (instruction manual, technical data, electrical diagram, exploded view and spare parts list)



DIMENSIONS (mm)

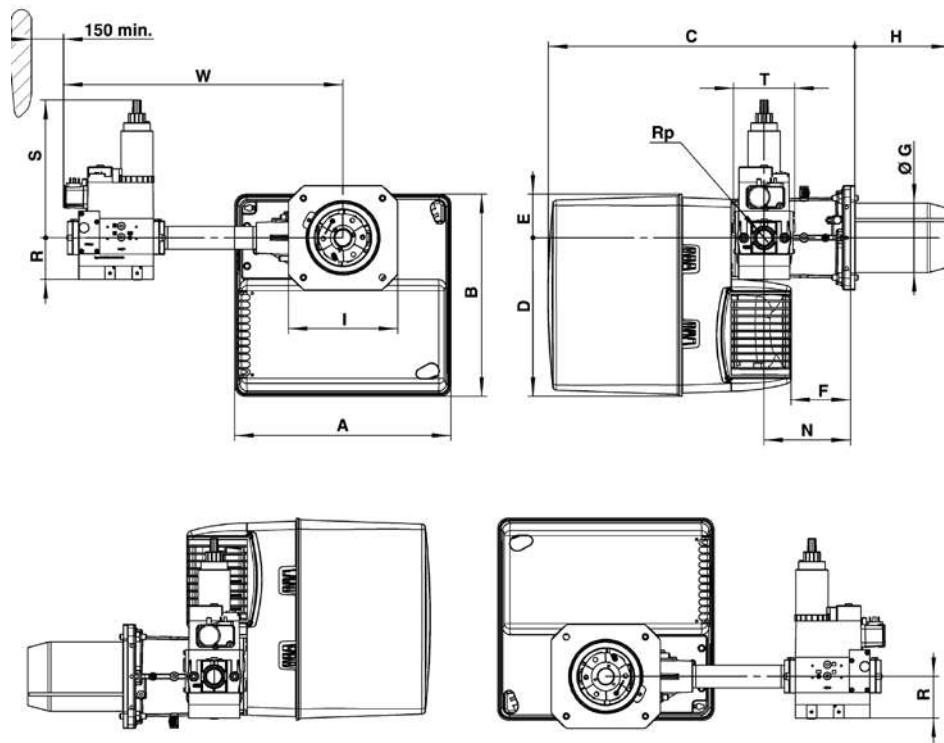

Gas train model	A	B	C	D	E	F	ØG	H		I	N	Rp	R	S	T	W
								KN	KL							
d1"1/2-Rp2"	465	475	640	377	97	149	150	220	360	245	195	2"	80	330	100	613
d1"1/4-Rp1"1/4	465	475	640	377	97	149	150	220	360	245	195	1"1/4	55	260	145	536
d3/4"-Rp3/4"	465	475	640	377	97	149	150	220	360	245	195	3/4"	46	210	120	489

Connecting flange

Øa (mm)	b (mm)	c	d
180-240	200-270	M10	45°

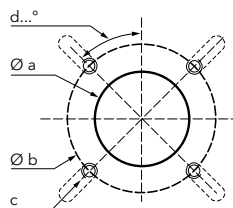

PACKAGING

The burner is delivered on a pallet in three packages containing:

- burner housing
- combustion head
- gas train and filter

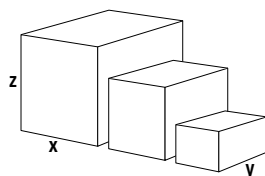

Component		Dimensions (mm)			Gross weight (kg)
		X	Y	Z	
Burner body	VG 4.460 D	490	490	590	28,7
	KN	750	260	295	8,9
Combustion head	KL	895	260	295	10,1
	d1"1/2-Rp2"	600	400	240	14
Gas train	d1"1/4-Rp1"1/4	440	320	240	10
	d3/4"-Rp3/4"	440	320	240	7

VG4.460 D

150 ... 460 kW
2 stages

PRESSURE LOSS [BURNER HEAD + GAS TRAIN] (mbar)

VG 4.460 D

Burner output (kW)	Natural gas G20 Hi = 10,35 kWh/m ³		Natural gas G25 Hi = 8,83 kWh/m ³		
	d3/4"-Rp3/4"	d1"1/4-Rp1"1/4	d3/4"-Rp3/4"	d1"1/4-Rp1"1/4	d1"1/2-Rp2"
250	19	6	28	7	4
300	27	9	40	10	6
350	37	12	54	13	8
400	48	15	71	17	10
460	64	20	94	23	13

Natural gas G20

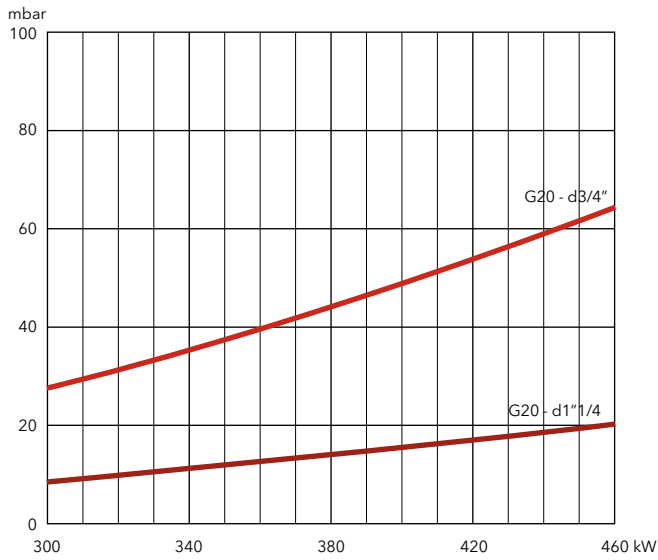

Natural gas G25

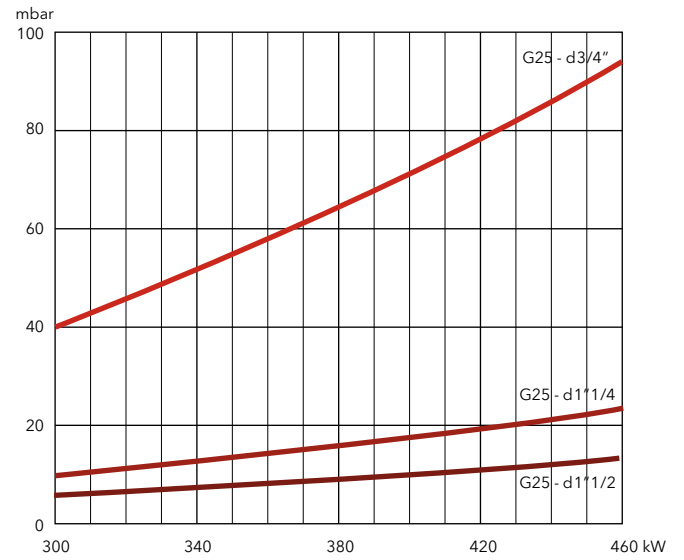



PRESSURE LOSS [BURNER HEAD + GAS TRAIN] (mbar)

VG 4.460 D

Burner output (kW)	LPG G31 Hi = 25,89 kWh/m ³	
	d3/4"-Rp3/4"	d1"1/4-Rp1"1/4
250	10	6
300	14	8
350	19	11
400	25	15
460	32	20

LPG

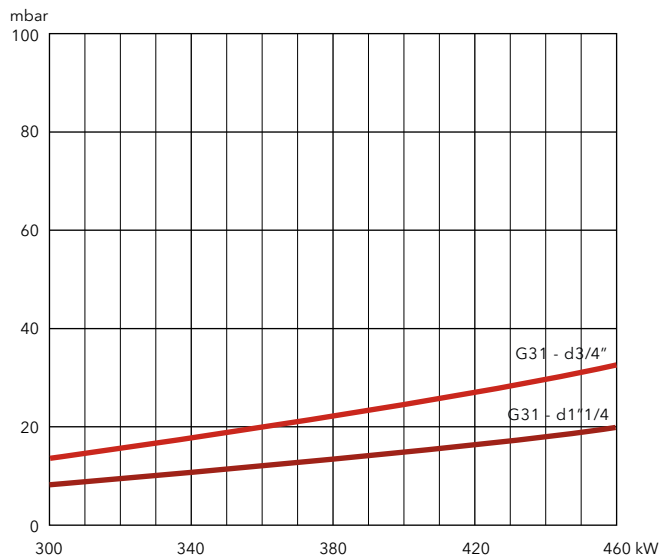

VG2.90 DP E / VG2.120 DP E / VG2.160 DP E / VG2.205 DP E

20 ... 205 kW

Two stage progressive/modulating pneumatic

- **Fuels:** natural gas (G20/G25, $H_u = 8,83...10,35 \text{ kWh/m}^3$); LPG (G31, $H_u = 25,89 \text{ kWh/m}^3$)
- **Emissions:** $\text{NO}_x < 56 \text{ mg/kWh}$ (GCV), burners compliant with ErP Directive
- **Operation:** two stage progressive or modulating with the installation of a power regulator and dedicated probes (see page 218)
- **Protection level:** IP 21



TECHNICAL DATA

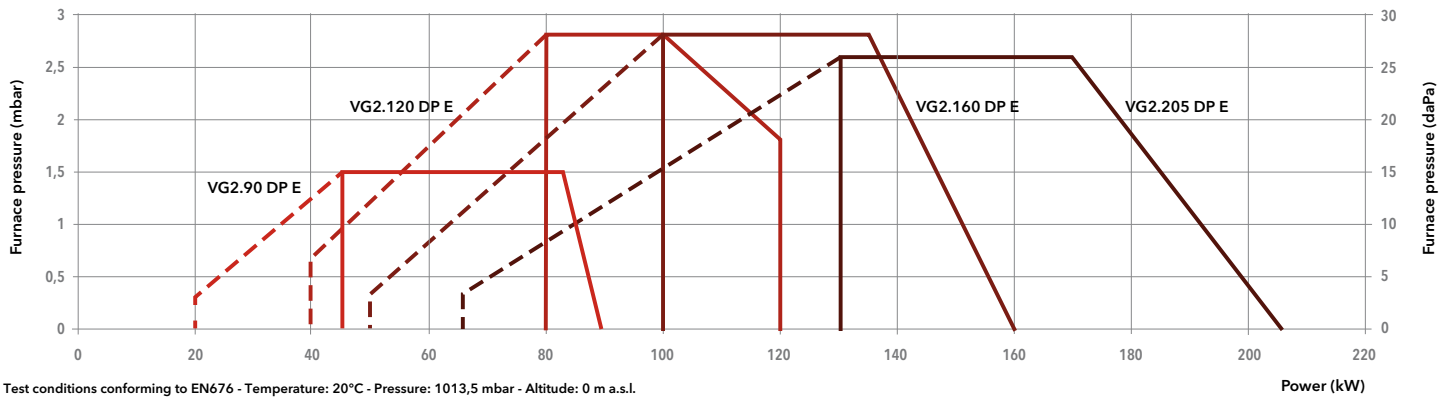

Model	VG2.90 DP E		VG2.120 DP E		VG2.160 DP E		VG2.205 DP E			
Operation range	(20) 45 - 90 kW		(40) 80 - 120 kW		(50) 100 - 160 kW		(65) 130 - 205 kW			
Gas pressure	20 - 100 mbar for d332 gas train; 100 - 360 mbar for d333		20 - 100 mbar for d332 gas train; 100 - 360 mbar for d333		20 - 100 mbar for d345 gas train; 100 - 360 mbar for d347		20 - 100 mbar for d345 and d348 gas trains; 100 - 360 for d346			
Control box / flame detection	TCG5... / ionization		TCG5... / ionization		TCG5... / ionization		TCG5... / ionization			
Fan motor	230 V - 50 Hz - 75 W		230 V - 50 Hz - 100 W		230 V - 50 Hz - 100 W		230 V - 50 Hz - 130 W			
Electrical consumption (min/max/stand-by)	140 W / 145 W / 4 W		239 W / 358 W / 4 W		285 W / 293 W / 4 W		302 W / 267 W / 4 W			
Acoustic level (LpA)	64 dB(A)		64 dB(A)		64 dB(A)		64 dB(A)			
CE certificate	0476 DN 1270		0476 CT 2423		0476 CT 2423		0476 CT 2423			
Head length		KN	KL	KN	KL	KN	KL	KN	KL	
Complete burner code	MB-VEF 407	d332-3/4"-Rp3/4"	3837232	3837233	3836364	3836365	-	-	-	-
	MB-VEF 407	d333-3/4"-Rp3/4"	3837234	3837235	3836366	3836367	-	-	-	-
	MB-VEF 407	d345-3/4"-Rp3/4"	-	-	-	-	3836368	3836369	3836374	3836375
	MB-VEF 407	d346-3/4"-Rp3/4"	-	-	-	-	-	-	3836376	3836377
	MB-VEF 407	d347-3/4"-Rp3/4"	-	-	-	-	3836370	3836371	-	-
	MB-VEF 412	d348-1"1/4-Rp1"1/4"	-	-	-	-	-	-	3836372	3836373

OTHER AVAILABLE VERSIONS

- 60 60 Hz version
- Vent Versions for continuous ventilation and post-ventilation

SCOPE OF SUPPLY

The burner is delivered in its package complete with:

- 1 gas connection flange
- 1 compact gas train with gas filter; the gas filter is built-in for threaded valves (up to 2") and separated for flanged ones (DN65/80/100)
- 1 burner flange with insulation
- 1 bag containing installation fittings
- 1 bag containing technical documentation (instruction manual, technical data, electrical diagram, exploded view and spare parts list)



DIMENSIONS (mm)

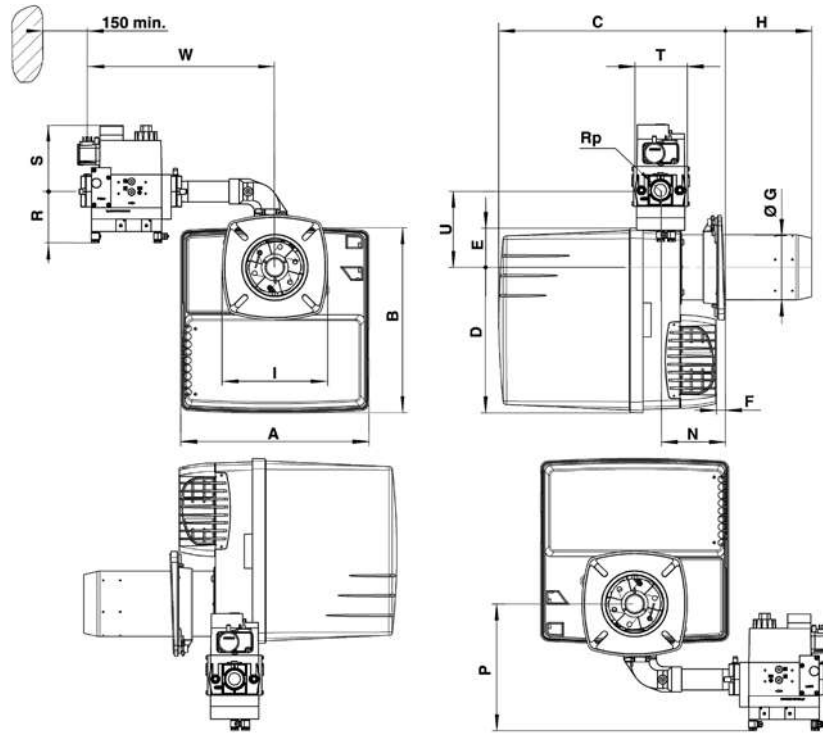

Model	Gas train model	A	B	C		D	E	F min	ØG	H		I	N min	P	Rp	R	S	T	U	W
				KN	KL					KN	KL									
VG2.90	d3/4"-Rp3/4"	331	325	398...480	398...600	256	69	15	100	70...150	70...270	185	105	179	3/4"	70	160	120	133	345
VG2.120	d3/4"-Rp3/4"	331	325	398...518	398...638	256	69	15	115	30...150	30...270	185	113	179	3/4"	70	160	120	133	345
VG2.160	d3/4"-Rp3/4"	331	325	398...518	398...638	256	69	15	115	30...150	30...270	185	113	179	3/4"	70	160	120	133	345
VG2.205	d3/4"-Rp3/4"	331	325	398...518	398...638	256	69	15	125	30...150	30...270	185	113	179	3/4"	70	160	120	133	345
	d1"1/4-Rp1"1/4	331	325	398...518	398...638	256	69	15	125	30...150	30...270	185	113	188	1"1/4	80	175	145	133	380

Connecting flange

Model	Øa (mm)	b (mm)	c	d
VG2.90...160	120-135	150-185	M8	45°
VG2.205	130-145	160-185	M8	45°

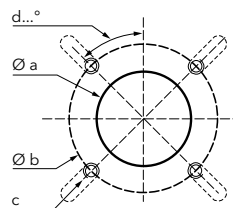

PACKAGING

The burner is delivered in a single package containing all the components

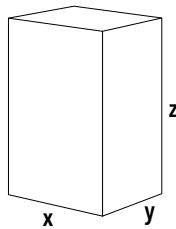

Burner	Dimensions (mm)			Gross weight (kg)
	X	Y	Z	
VG2.90	400	400	760	26
VG2.120	400	400	760	26
VG2.160	400	400	760	26
VG2.205	400	400	760	26

VG2.90 DP E / VG2.120 DP E / VG2.160 DP E / VG2.205 DP E

20 ... 205 kW

Two stage progressive/modulating pneumatic

PRESSURE LOSS [BURNER HEAD + GAS TRAIN] (mbar)

VG2.90 DP E

Burner output (kW)	Natural gas G20 Hi = 10,35 kWh/m ³	Natural gas G25 Hi = 8,83 kWh/m ³
	d3/4"-Rp3/4"	d3/4"-Rp3/4"
30	2,8	3,4
50	5,7	7,5
70	9,4	12,8
90	14	19,6

Natural gas G20

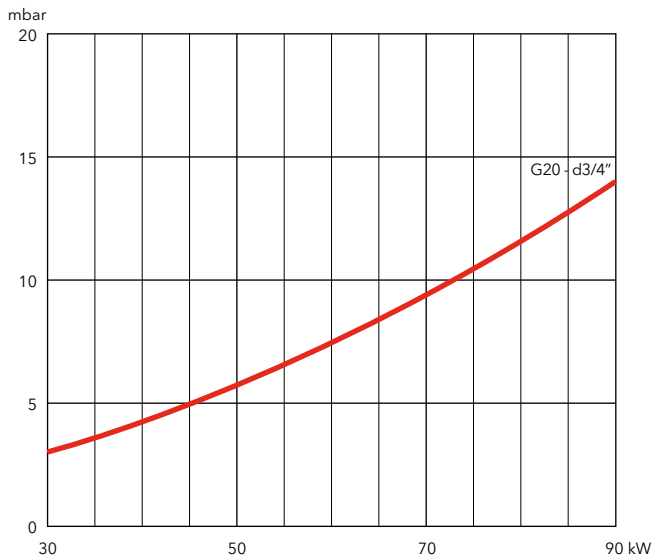

Natural gas G25

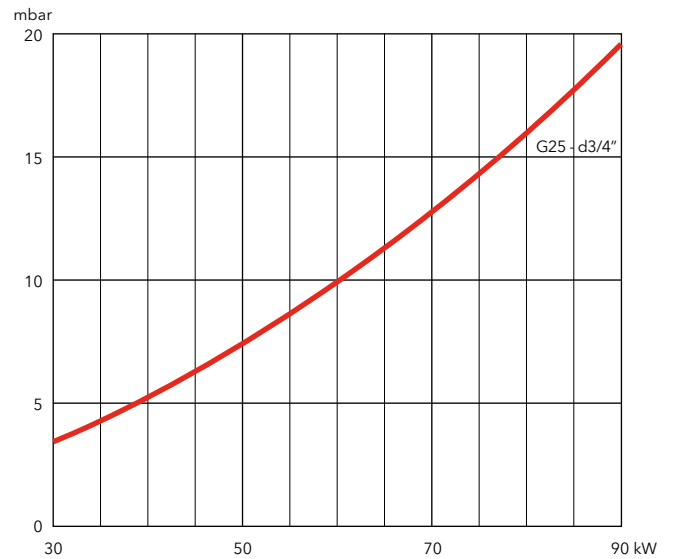



PRESSURE LOSS [BURNER HEAD + GAS TRAIN] (mbar)

VG2.90 DP E

Burner output (kW)	LPG G31 Hi = 25,89 kWh/m ³
	d3/4"·Rp3/4"
30	2,7
50	5,1
70	8
90	11,4

LPG

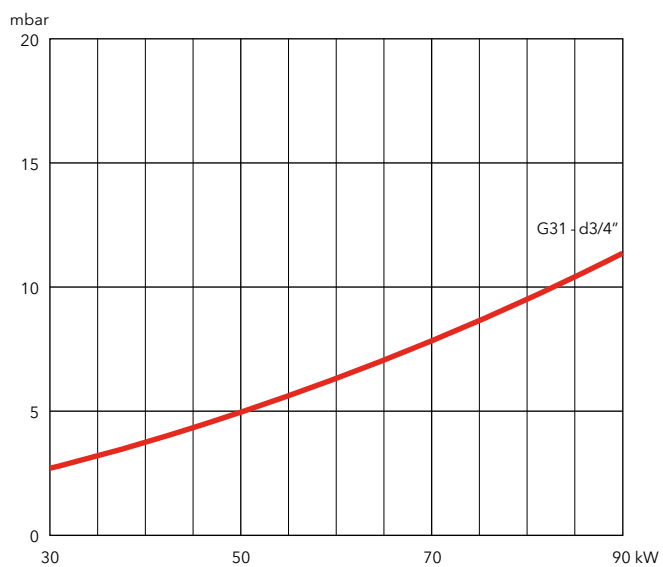

VG3.290 DP E / VG3.350 DP E

95 ... 350 kW

Two stage progressive/modulating pneumatic

- **Fuels:** natural gas (G20/G25, $H_u = 8,83...10,35 \text{ kWh/m}^3$); LPG (G31, $H_u = 25,89 \text{ kWh/m}^3$)
- **Emissions:** $\text{NO}_x < 56 \text{ mg/kWh}$ (GCV), burners compliant with ErP Directive
- **Operation:** two stage progressive or modulating with the installation of a power regulator and dedicated probes (see page 218)
- **Protection level:** IP 21



TECHNICAL DATA

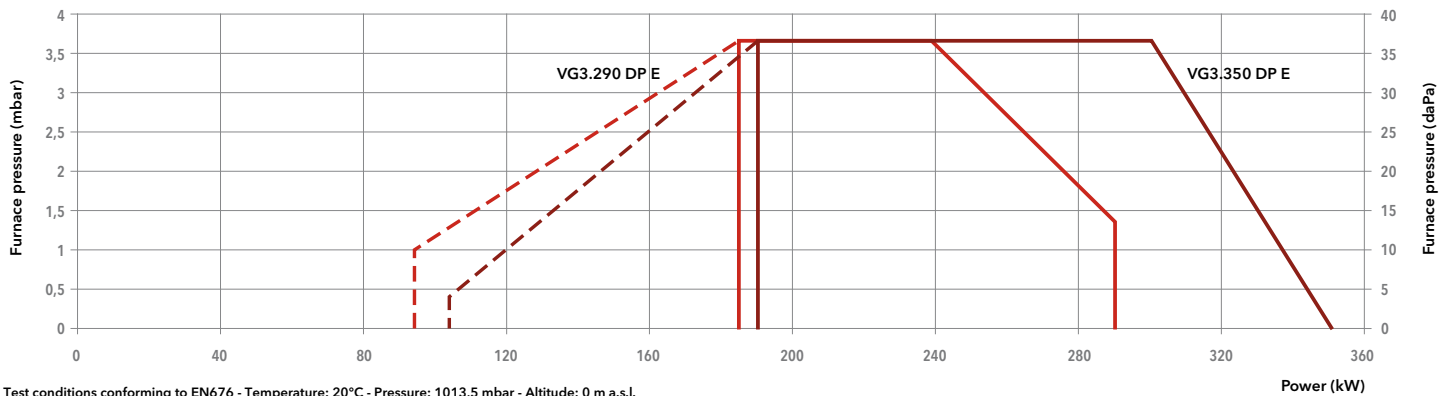

	VG3.290 DP E		VG3.350 DP E	
Operation range	(95) 185 - 290 kW		(105) 190 - 350 kW	
Gas pressure	20 - 360 mbar		20 - 360 mbar	
Control box / flame detection	TCG5... / ionization		TCG5... / ionization	
Fan motor	230 V - 50 Hz - 250 W		230 V - 50 Hz - 300 W	
Electrical consumption (max/min/stand-by)	465 W / 441 W / 4 W		583 W / 583 W / 4 W	
Acoustic level (LpA)	67 dB(A)		69 dB(A)	
CE certificate	0476 CT 2423		0476 CT 2423	
Head length	KN	KL	KN	KL
Complete burner code	MB-VEF 420 d1"1/2-Rp2"	-	3836414	3836415
	MB-VEF 412 d1"1/4-Rp1"1/4	3836410	3836416	3836417
	MB-VEF 407 d3/4"-Rp1"	3836412	3836413	3836419

OTHER AVAILABLE VERSIONS

- 60 60 Hz version
- TC Version with tightness control
- V_{vent} Versions for continuous ventilation and post-ventilation

SCOPE OF SUPPLY

The burner is delivered in its package complete with:

- 1 burner head with flange seal and securing screws
- 1 compact gas train with gas filter; the gas filter is built-in for threaded valves (up to 2") and separated for flanged ones (DN65/80/100)
- 1 bag containing installation fittings
- 1 bag containing technical documentation (instruction manual, technical data, electrical diagram, exploded view and spare parts list)



DIMENSIONS (mm)

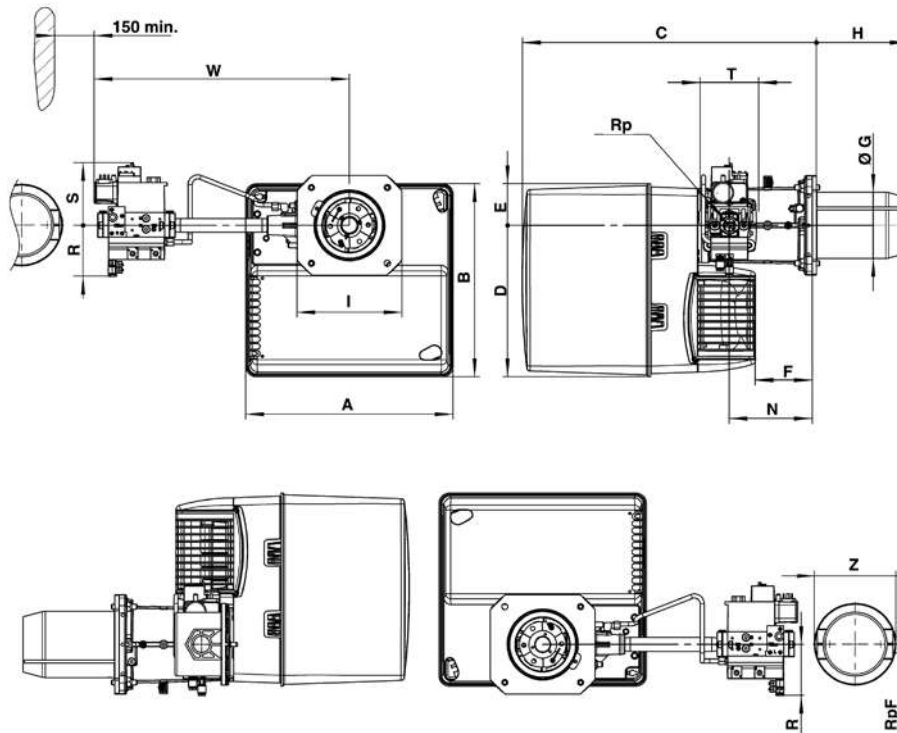

Gas train model	A	B	C	D	E	F	ØG	H		I	N	Rp	R	S	T	W	RpF	Z
								KN	KL									
d1"1/2-Rp2"	406	379	576	297	82	120	130	180	320	195x205	170	2"	100	185	100	603	-	-
d1"1/4-Rp1"1/4	406	379	576	297	82	120	130	180	320	195x205	170	1"1/4	80	175	145	526	-	-
d3/4"-Rp1"	406	379	576	297	82	120	130	180	320	195x205	170	1"	70	160	120	479	1"	160

Connecting flange

Øa (mm)	b (mm)	c	d
155-190	175-220	M10	45°

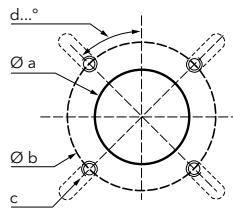

PACKAGING

The burner is delivered on a pallet in three packages containing:

- burner housing
- combustion head
- gas train and filter

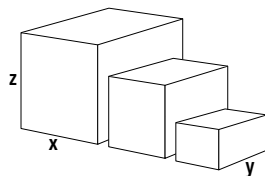

Component		Dimensions (mm)			Gross weight (kg)
		X	Y	Z	
Body	VG3.290 DP E	440	400	520	21
	VG3.350 DP E	440	400	520	21
Combustion head	KN	650	210	260	6
	KL	780	210	260	7
Gas train	d1"1/2-Rp2"	670	550	380	12
	d1"1/4-Rp1"1/4	600	400	240	11
	d3/4"-Rp1"	600	400	240	7

VG3.290 DP E / VG3.350 DP E

95 ... 350 kW

Two stage progressive/modulating pneumatic

PRESSURE LOSS [BURNER HEAD + GAS TRAIN] (mbar)

VG3.290 DP E

Burner output (kW)	Natural gas G20 Hi = 10,35 kWh/m ³		Natural gas G25 Hi = 8,83 kWh/m ³		LPG G31 Hi = 25,89 kWh/m ³	
	d3/4"-Rp1"	d1"1/4-Rp1"1/4	d3/4"-Rp1"	d1"1/4-Rp1"1/4	d3/4"-Rp1"	d1"1/4-Rp1"1/4
190	17	9	22	11	11	7
210	18	9	24	12	12	7
230	20	9	27	12	12	7
250	22	10	31	13	13	8
270	25	11	35	15	14	8
290	29	13	40	16	16	9

Natural gas G20

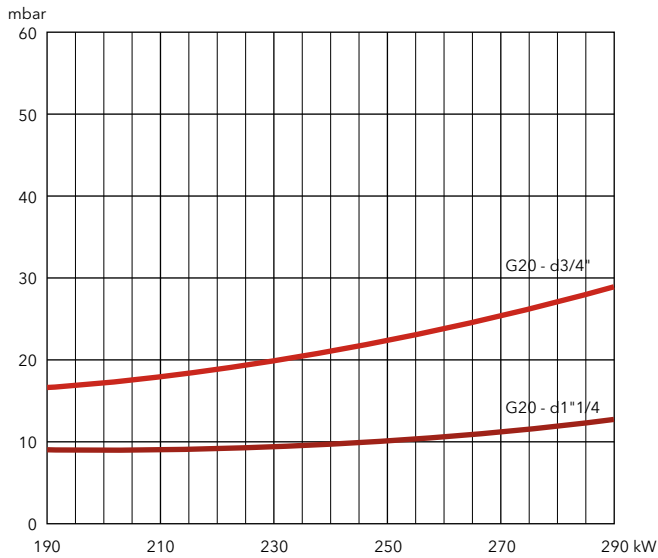

Natural gas G25

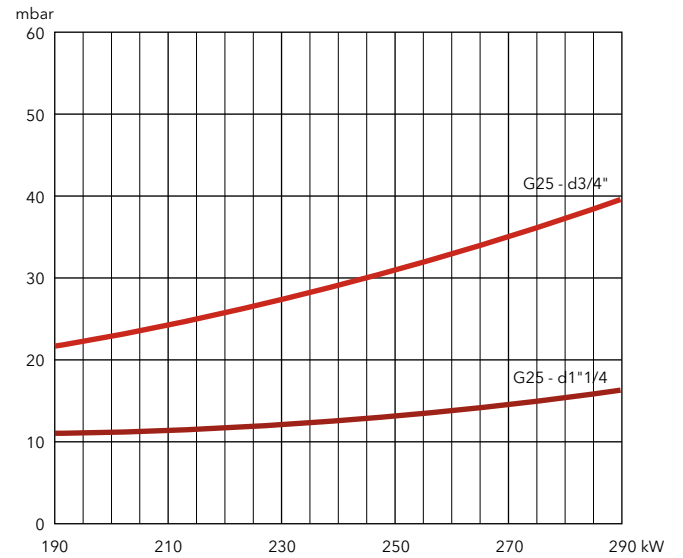

LPG

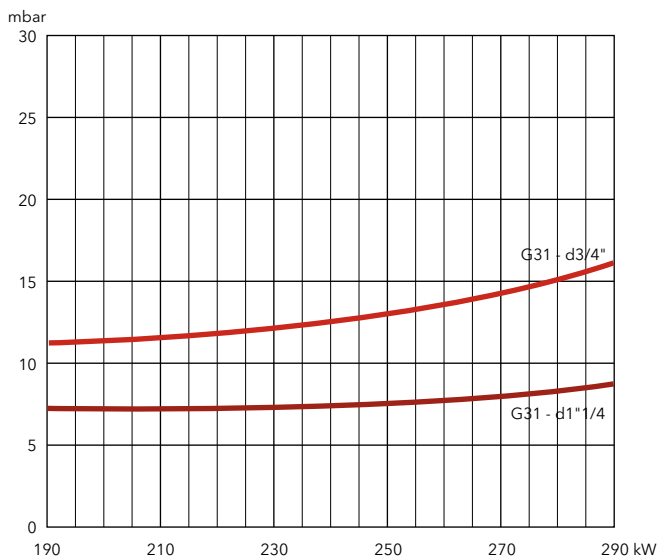



PRESSURE LOSS [BURNER HEAD + GAS TRAIN] (mbar)

VG3.350 DP E

Burner output (kW)	Natural gas G20 Hi = 10,35 kWh/m ³			Natural gas G25 Hi = 8,83 kWh/m ³			LPG G31
	d3/4"-Rp1"	d1"1/4-Rp1"1/4	d1"1/2-Rp2"	d3/4"-Rp1"	d1"1/4-Rp1"1/4	d1"1/2-Rp2"	d3/4"-Rp1"
190	13	6	6	19	8	8	8
230	17	7	7	26	11	10	12
270	23	9	8	35	15	13	15
310	29	11	10	44	18	16	18
350	36	14	12	54	22	19	22

Natural gas G20

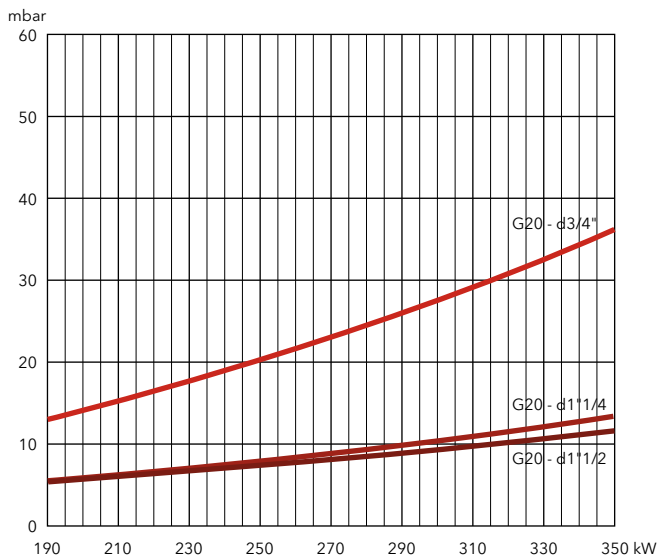

Natural gas G25

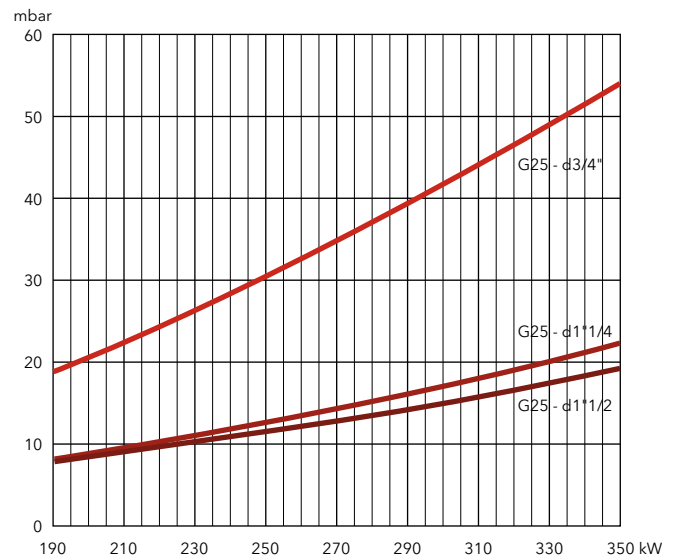

LPG

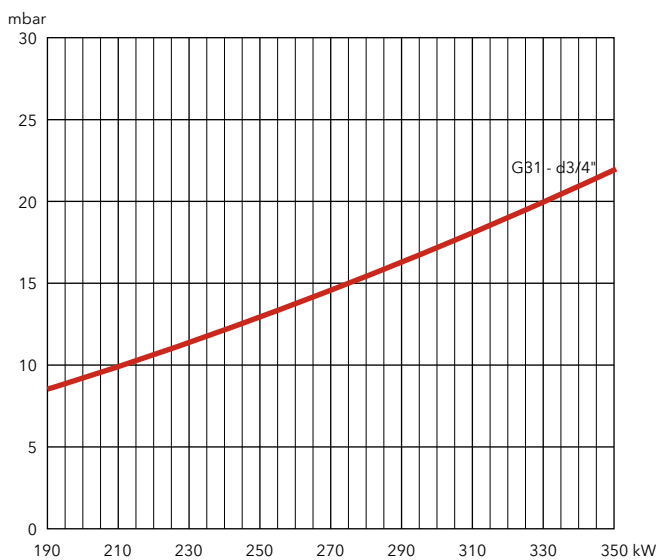

VG4.440 DP E

110 ... 440 kW

Two stage progressive/modulating pneumatic

- **Fuels:** natural gas (G20/G25, $H_u = 8,83...10,35 \text{ kWh/m}^3$); LPG (G31, $H_u = 25,89 \text{ kWh/m}^3$)
- **Emissions:** $\text{NO}_x < 56 \text{ mg/kWh}$ (GCV), burners compliant with ErP Directive
- **Operation:** two stage progressive or modulating with the installation of a power regulator and dedicated probes (see page 218)
- **Protection level:** IP 21



TECHNICAL DATA

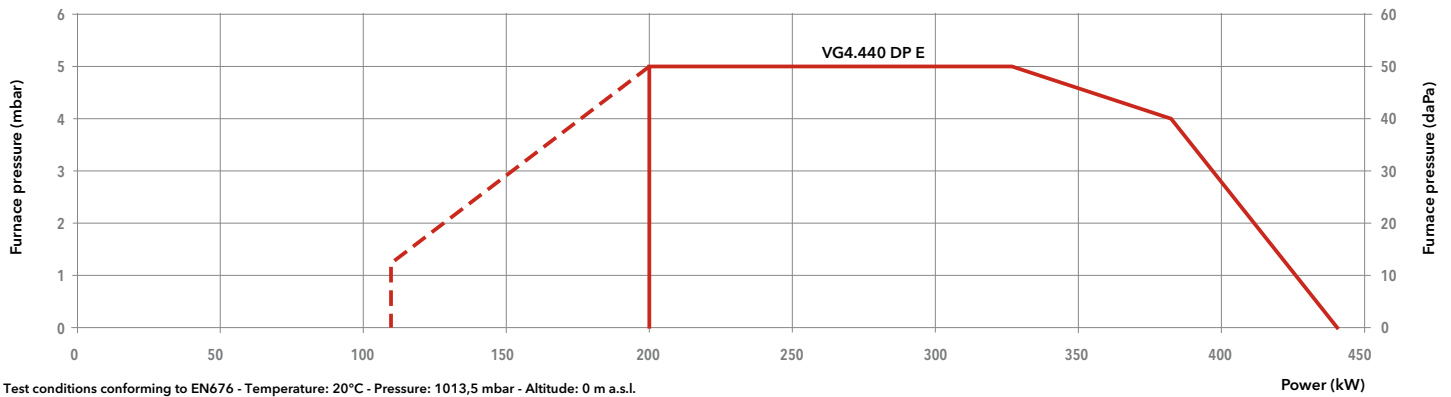

Model		VG4.440 DP E	
Operation range		(110) 200 - 440 kW	
Gas pressure		20 - 360 mbar	
Control box / flame detection		TCG5.../ionization	
Fan motor		230 V - 50 Hz - 420 W	
Electrical consumption (max/min/stand-by)		606 W / 569 W / 4 W	
Acoustic level (LpA)		70 dB(A)	
CE certificate		0476 CT 2423	
Head length		KN	KL
Complete burner code	MB-VEF 420 d1"1/2-Rp2"	3836430	3836431
	MB-VEF 412 d1"1/4-Rp1"1/4	3836432	3836433
	MB-VEF 407 d3/4"-Rp1"	3836434	3836435

OTHER AVAILABLE VERSIONS

- 60 60 Hz version
- TC Version with tightness control
- V_{vent} Versions for continuous ventilation and post-ventilation

SCOPE OF SUPPLY

The burner is delivered in its package complete with:

- 1 burner head with flange seal and securing screws
- 1 compact gas train with gas filter; the gas filter is built-in for threaded valves (up to 2") and separated for flanged ones (DN65/80/100)
- 1 bag containing installation fittings
- 1 bag containing technical documentation (instruction manual, technical data, electrical diagram, exploded view and spare parts list)



DIMENSIONS (mm)

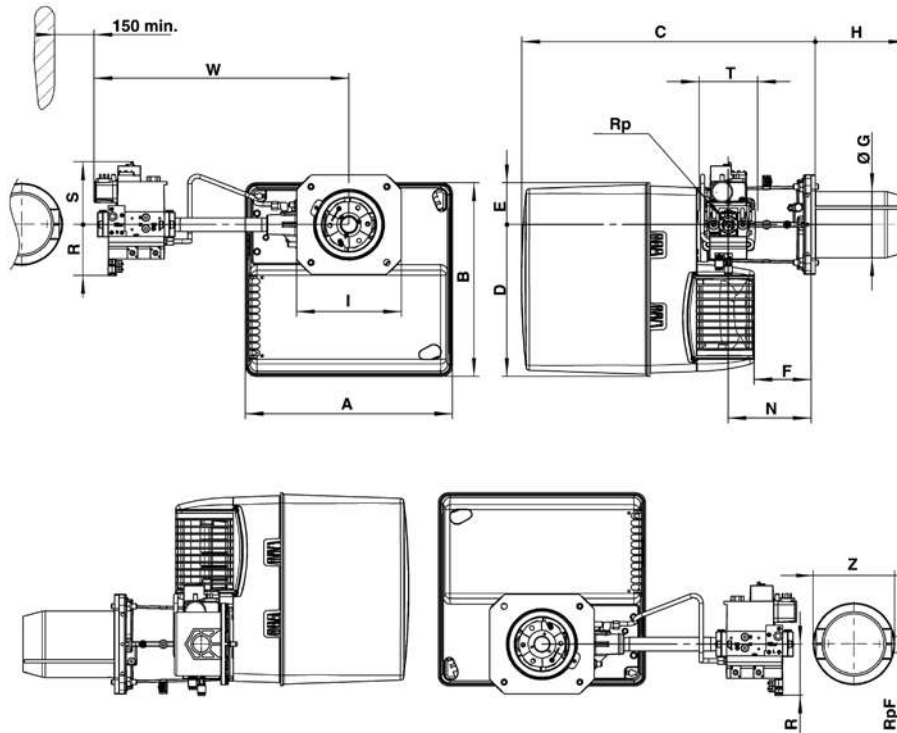

Gas train model	A	B	C	D	E	F	ØG	H		I	N	Rp	R	S	T	W	RpF	Z
								KN	KL									
d1"1/2-Rp2"	465	475	640	377	97	149	157	212	352	245	195	2"	100	185	100	613	-	-
d1"1/4-Rp1"1/4	465	475	640	377	97	149	157	212	352	245	195	1"1/4	80	175	145	536	-	-
d3/4"-Rp1"	465	475	640	377	97	149	157	212	352	245	195	1"	70	160	120	489	1"	160

Connecting flange

Øa (mm)	b (mm)	c	d
190-240	200-270	M10	45°

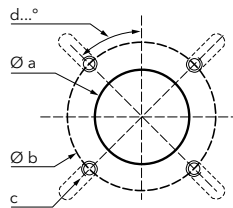

PACKAGING

The burner is delivered on a pallet in three packages containing:

- burner housing
- combustion head
- gas train and filter

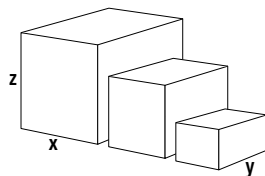

Component		Dimensions (mm)			Gross weight (kg)
		X	Y	Z	
Burner body	VG4.440 DP E	490	490	590	28,6
	KN	750	260	295	8,9
Combustion head	KL	895	260	295	10,1
	d1"1/2-Rp2"	670	550	380	12
Gas train	d1"1/4-Rp1"1/4	600	400	240	11
	d3/4"-Rp1"	600	400	240	7

VG4.440 DP E

110 ... 440 kW

Two stage progressive/modulating pneumatic

PRESSURE LOSS [BURNER HEAD + GAS TRAIN] (mbar)

VG4.440 DP E

Burner output (kW)	Natural gas G20 Hi = 10,35 kWh/m ³			Natural gas G25 Hi = 8,83 kWh/m ³		
	d3/4"-Rp1"	d1"1/4-Rp1"1/4	d1"1/2-Rp2"	d3/4"-Rp1"	d1"1/4-Rp1"1/4	d1"1/2-Rp2"
240	19	8	7	27	11	10
280	24	9	8	35	13	11
320	30	11	9	42	15	12
360	37	13	11	51	18	15
400	44	15	13	64	22	17
440	51	18	15	78	25	20

Natural gas G20

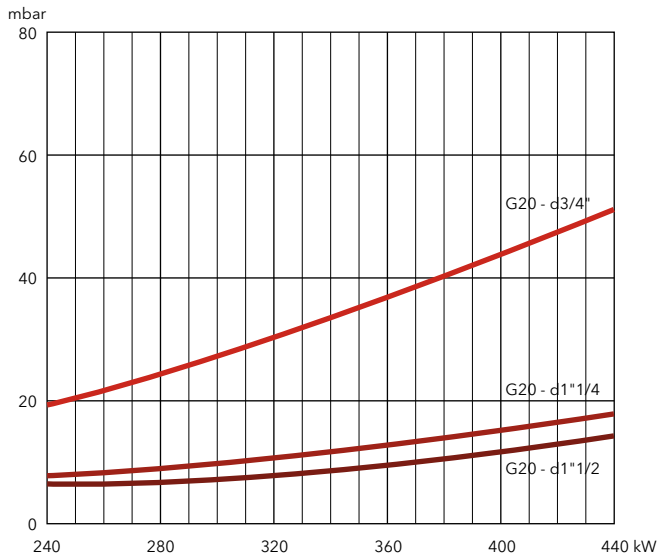

Natural gas G25

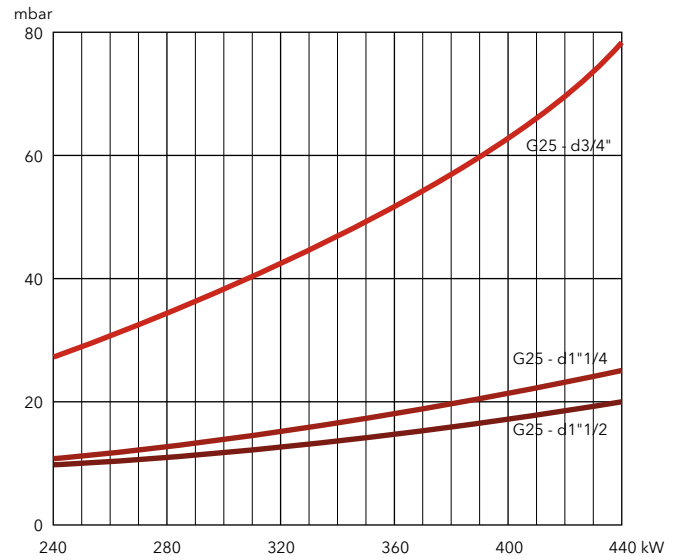



PRESSURE LOSS [BURNER HEAD + GAS TRAIN] (mbar)

VG4.440 DP E

Burner output (kW)	LPG G31 Hi = 25,89 kWh/m ³	
	d3/4"-Rp1"	d1"1/4-Rp1"1/4
240	13	8
280	16	9
320	18	10
360	22	11
400	26	13
440	32	16

LPG

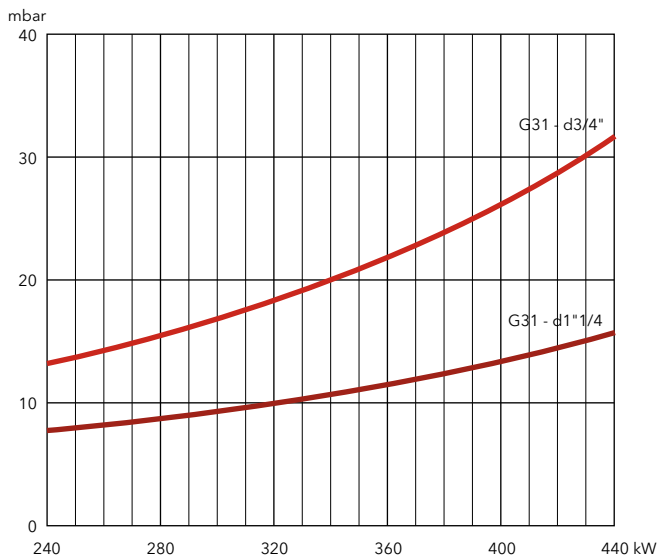

VG4.460 DP / VG4.610 DP

100 ... 610 kW

Two stage progressive/modulating pneumatic

- **Fuels:** natural gas, net calorific value 8,83...10,35 kWh/m³;
LPG, net calorific value 25,89 kWh/m³
- **Emissions:** NOx < 70 mg/kWh (NCV), Low NOx class 3 burners according to EN676
- **Operation:** two stage progressive or modulating with the installation of a power regulator and dedicated probes (see page 218)
- **Protection level:** IP 41



TECHNICAL DATA

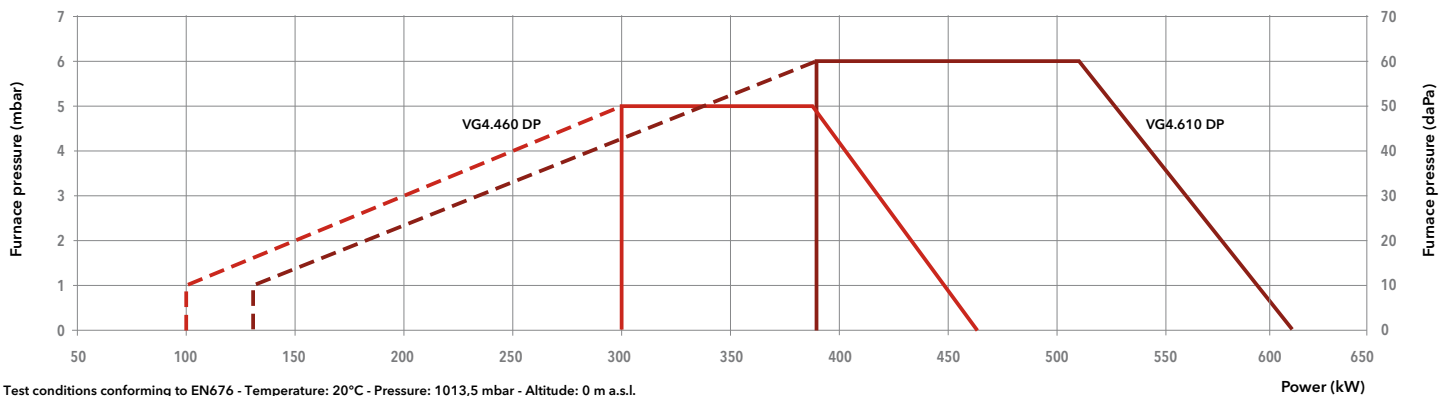

Model	VG 4.460 DP		VG 4.610 DP	
Operation range	(100) 300 - 460 kW		(130) 390 - 610 kW	
Gas pressure	20 - 300 mbar		20 - 300 mbar	
Control box / flame detection	TCG5... / ionization		TCG5... / ionization	
Fan motor	230 V - 50 Hz - 420 W		230 V - 50 Hz - 750 W	
Electrical consumption	68 + 522 W		68 + 720 W	
Acoustic level (LpA)	70 dB(A)		71 dB(A)	
CE certificate	1312 CL 5412		1312 CL 5412	
Head length	KN	KL	KN	KL
Complete burner code	MB-VEF 420 d1"1/2-Rp2"	3833423	3833415	3833416
	MB-VEF 412 d1"1/4-Rp1"1/4"	3833411	3833417	3833418
	MB-VEF 407 d3/4"-Rp1"	3833413	3833419	3833420

OTHER AVAILABLE VERSIONS

- 60 60 Hz version
- TC Version with tightness control
- V_{vent} Versions for continuous ventilation and post-ventilation

SCOPE OF SUPPLY

The burner is delivered in its package complete with:

- 1 burner head with flange seal and securing screws
- 1 compact gas train with gas filter
- 1 bag containing installation fittings
- 1 bag containing technical documentation (instruction manual, technical data, electrical diagram, exploded view and spare parts list)

DIMENSIONS (mm)

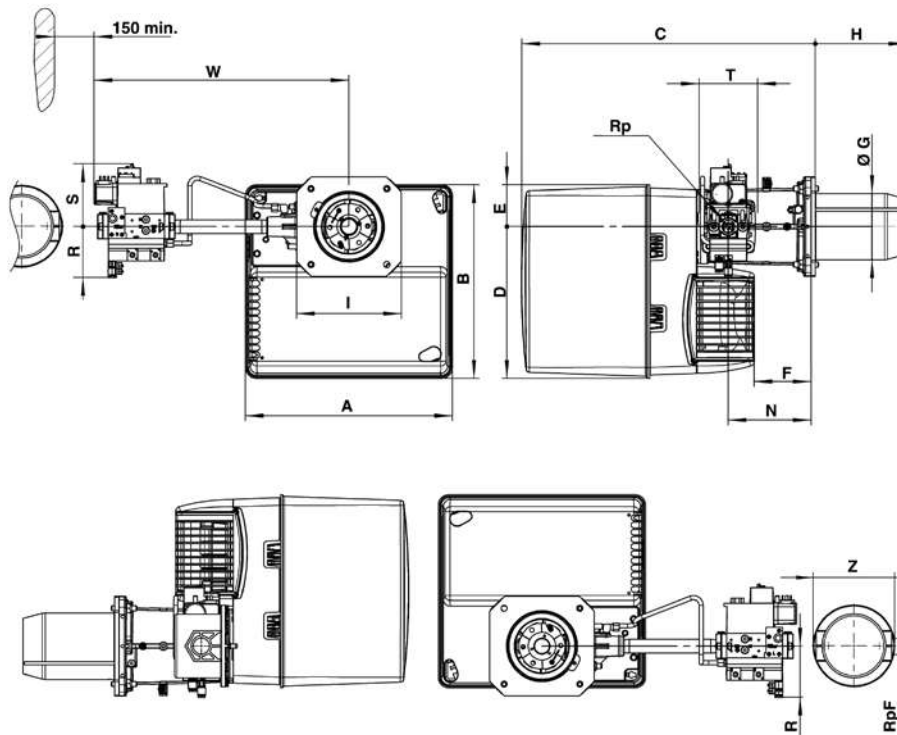

Gas train model	A	B	C	D	E	F	ØG	H		I	N	Rp	R	S	T	W	RpF	Z
								KN	KL									
d1"1/2-Rp2"	465	475	640	377	97	149	150	220	360	245	195	2"	100	185	100	613	-	-
d1"1/4-Rp1"1/4	465	475	640	377	97	149	150	220	360	245	195	1"1/4	80	175	145	536	-	-
d3/4"-Rp1"	465	475	640	377	97	149	150	220	360	245	195	1"	70	160	120	489	1"	160

Connecting flange

Øa (mm)	b (mm)	c	d
180-240	200-270	M10	45°

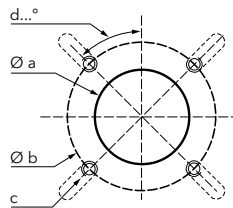

PACKAGING

The burner is delivered on a pallet in three packages containing:

- burner housing
- combustion head
- gas train and filter

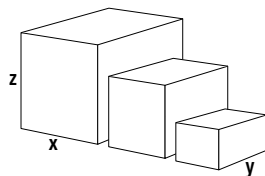

Component		Dimensions (mm)			Gross weight (kg)
		X	Y	Z	
Burner body	VG 4.460 DP	490	490	590	28,6
	VG 4.610 DP	490	490	590	32,7
Combustion head	KN	750	260	295	8,9
	KL	895	260	295	10,1
Gas train	d1"1/2-Rp2"	670	550	380	12
	d1"1/4-Rp1"1/4	600	400	240	11
	d3/4"-Rp1"	600	400	240	7

VG4.460 DP / VG4.610 DP

100 ... 610 kW

Two stage progressive/modulating pneumatic

PRESSURE LOSS [BURNER HEAD + GAS TRAIN] (mbar)

VG 4.460 DP

Burner output (kW)	Natural gas G20 Hi = 10,35 kWh/m ³		Natural gas G25 Hi = 8,83 kWh/m ³			LPG G31 Hi = 25,89 kWh/m ³	
	d3/4"-Rp1"	d1"1/4-Rp1"1/4	d3/4"-Rp1"	d1"1/4-Rp1"1/4	d1"1/2-Rp2"	d3/4"-Rp1"	d1"1/4-Rp1"1/4
300	40	8	59	11	6	18	8
350	54	10	81	15	9	24	11
400	70	14	106	19	12	31	14
450	89	17	134	24	15	40	18
510	114	22	172	31	19	51	23

Natural gas G20

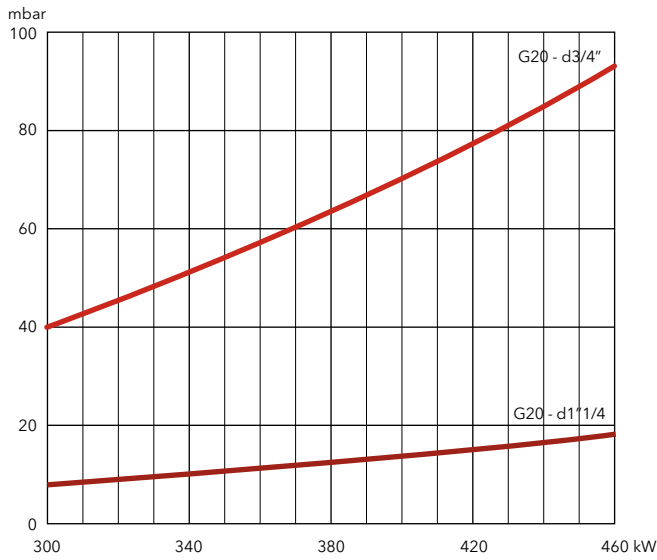

Natural gas G25

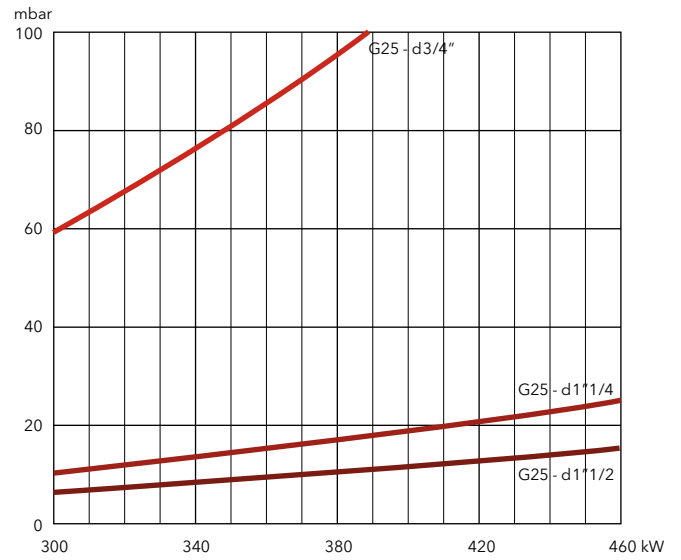

LPG

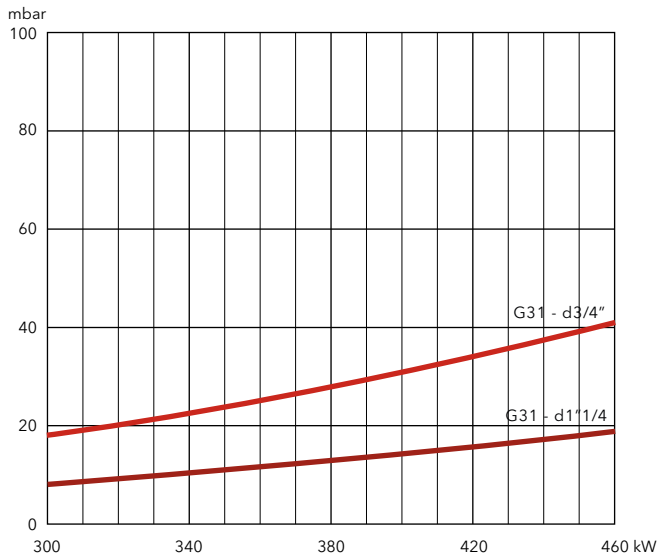



PRESSURE LOSS [BURNER HEAD + GAS TRAIN] (mbar)

VG 4.610 DP

Burner output (kW)	Natural gas G20 Hi = 10,35 kWh/m ³			Natural gas G25 Hi = 8,83 kWh/m ³			LPG G31 Hi = 25,89 kWh/m ³	
	d3/4"-Rp1"	d1"1/4-Rp1"1/4	d1"1/2-Rp2"	d3/4"-Rp1"	d1"1/4-Rp1"1/4	d1"1/2-Rp2"	d3/4"-Rp1"	d1"1/4-Rp1"1/4
350	53	9	6	78	13	7	25	8
400	70	12	8	102	17	9	32	10
450	88	16	10	129	21	11	41	13
500	109	19	12	159	26	14	50	16
550	132	23	15	192	32	17	61	20
610	162	29	18	236	39	20	75	24

Natural gas G20

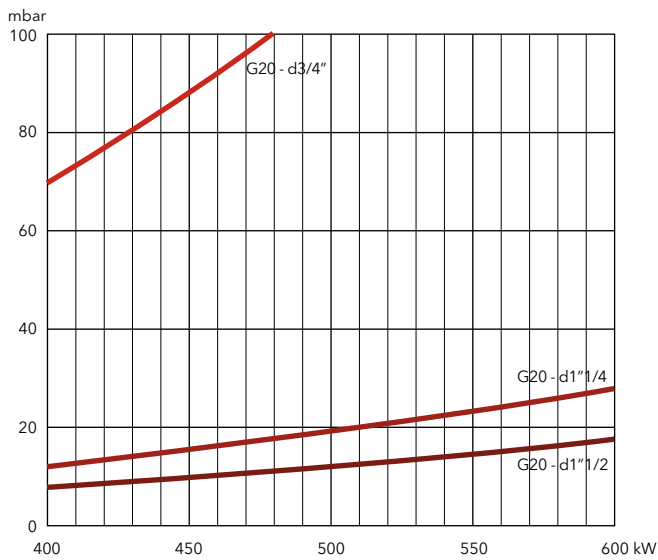

Natural gas G25

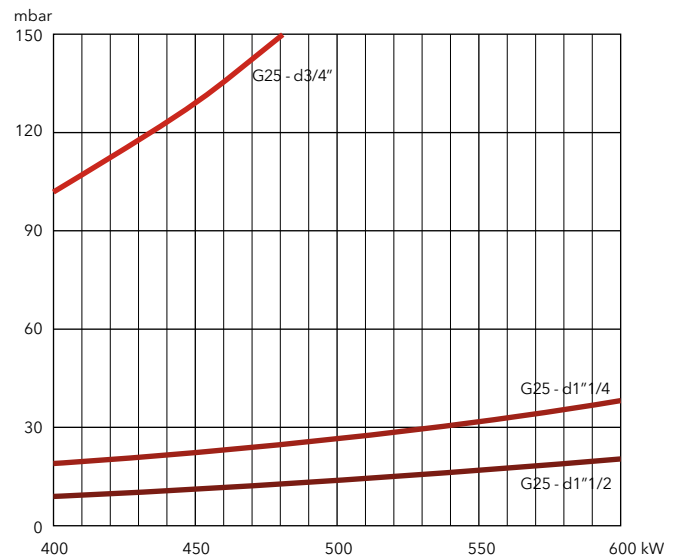

LPG

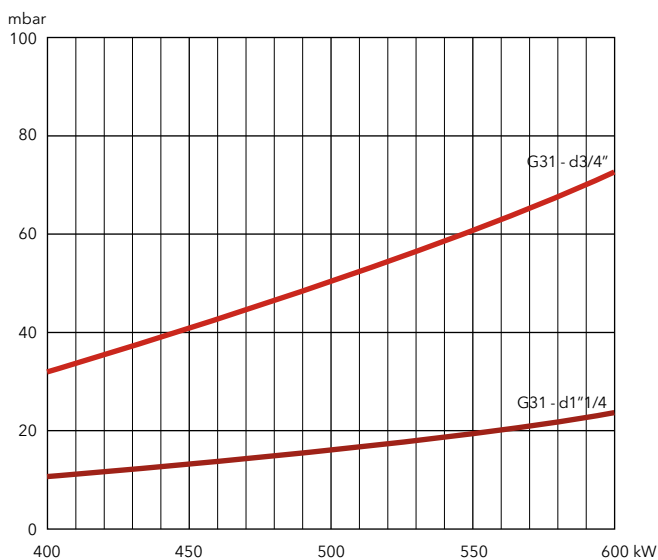

VG5.750 DP

160 ... 800 kW
Two stage progressive/modulating pneumatic



- **Fuels:** natural gas (G20/G25, $H_u = 8,83...10,35 \text{ kWh/m}^3$); LPG (G31, $H_u = 25,89 \text{ kWh/m}^3$)
- **Emissions:** $\text{NO}_x < 70 \text{ mg/kWh}$ (NCV), Low NO_x class 3 burners according to EN676
- **Operation:** two stage progressive or modulating with the installation of a power regulator and dedicated probes (see page 218)
- **Protection level:** IP 21

TECHNICAL DATA

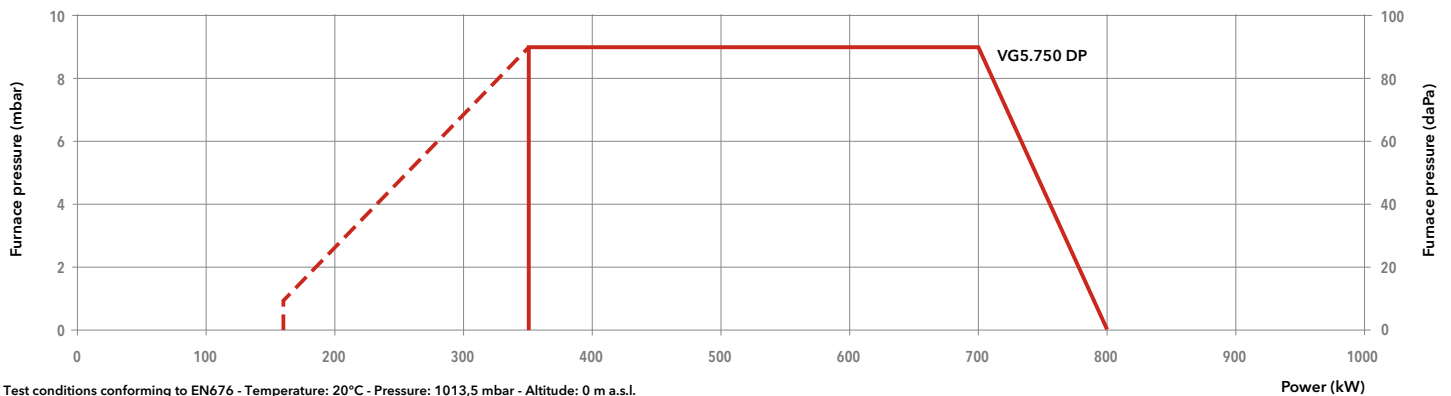

Model	VG5.750 DP		
Operation range	(160) 350 – 800 kW		
Gas pressure	20 – 300 mbar		
Control box / flame detection	TCG 5../ionization		
Fan motor	230/400 V – 50 Hz – 1,1 kW		
Electrical consumption	63 + 1800 W		
Acoustic level (LpA)	77 dB(A)		
CE certificate	0476 DN 1270		
Head length	KN	KL	KM
Complete	VGD 20-5011 s2"-Rp2" 3837024	3837030	3837034
burner code	MB-VEF 420 d1"1/2-Rp2" 3837025	3837031	3837035
	MB-VEF 412 d1"1/4-Rp2" 3837026	3837032	3837036
	MB-VEF 407 d3/4"-Rp1" 3837027	3837033	3837037

OTHER AVAILABLE VERSIONS

- 60 60 Hz version
- TC Version with tightness control
- V_{ent} Versions for continuous ventilation and post-ventilation

SCOPE OF SUPPLY

The burner is delivered in its package complete with:

- 1 burner head with flange seal and securing screws
- 1 compact gas train with gas filter; the gas filter is built-in for threaded valves (up to 2") and separated for flanged ones (DN65/80/100)
- 1 bag containing installation fittings
- 1 bag containing technical documentation (instruction manual, technical data, electrical diagram, exploded view and spare parts list)

DIMENSIONS (mm)

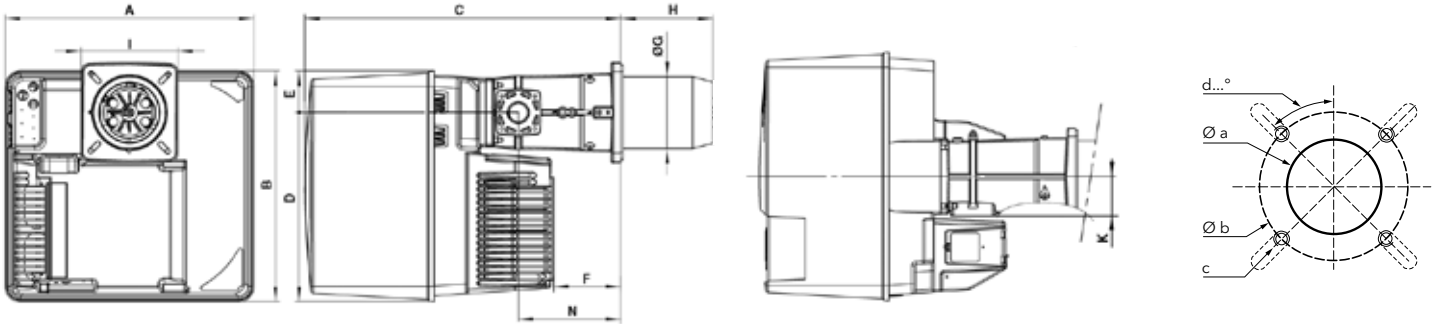

A	B	C	D	E	F	ØG	H			I	K	N
							KN	KM	KL			
581	549	752	450	99	164	170	285	395	505	230x238	89	244

Øa (mm)	b (mm)	c	d
195	220-260	M10	45°

Gas trains

Gas train "d":

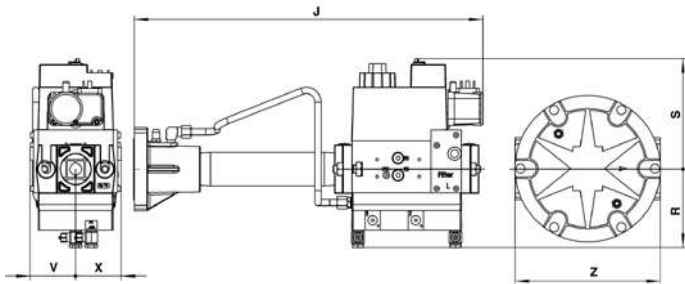

Model	J	R	S	V	X	Z
d1"1/2-Rp2"	540	123	190	55	55	-
d1"1/4-Rp2"	450	100	141	58	58	186
d3/4"-Rp1"	420	100	122	55	50	160

Gas train "s":

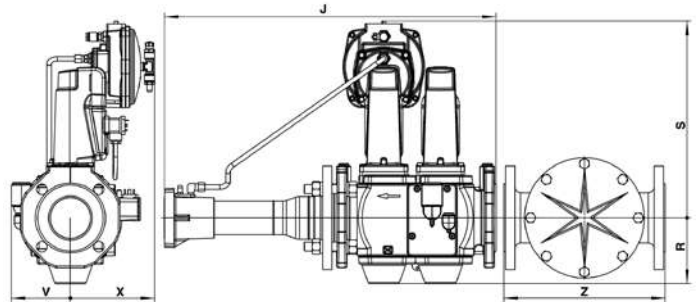

Model	J	R	S	V	X	Z
s2"-Rp2"	612	103	330	110	150	186

PACKAGING

The burner is delivered on a pallet in three packages containing:

- burner housing
- combustion head
- gas train and filter

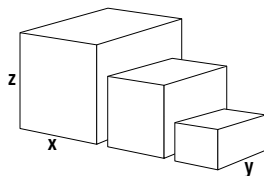

Component	Dimensions (mm)			Gross weight (kg)	
	X	Y	Z		
Burner body	800	600	850	54	
Combustion head	KN	780	265	280	12,3
	KL	1010	265	280	14,4
	KM	1010	265	280	13,4
	s2"-Rp2"	790	600	500	17,2
	d1"1/2-Rp2"	670	550	380	12
	d1"1/4-Rp2"	600	400	240	12
	d3/4"-Rp1"	600	400	240	7

VG5.750 DP

160 ... 800 kW

Two stage progressive/modulating pneumatic

PRESSURE LOSS [BURNER HEAD + GAS TRAIN] (mbar)

VG5.750 DP

Burner output (kW)	Natural gas G20 Hi = 10,35 kWh/m ³				Natural gas G25 Hi = 8,83 kWh/m ³		
	d3/4"-Rp1"	d1"1/4-Rp2"	d1"1/2-Rp2"	s2"-Rp2"	d1"1/4-Rp2"	d1"1/2-Rp2"	s2"-Rp2"
400	41	14	12	7	18	13	7
500	59	20	16	10	26	18	11
600	81	27	21	14	35	23	15
700	106	35	26	19	46	29	21
800	133	44	31	24	59	36	27

Natural gas G20

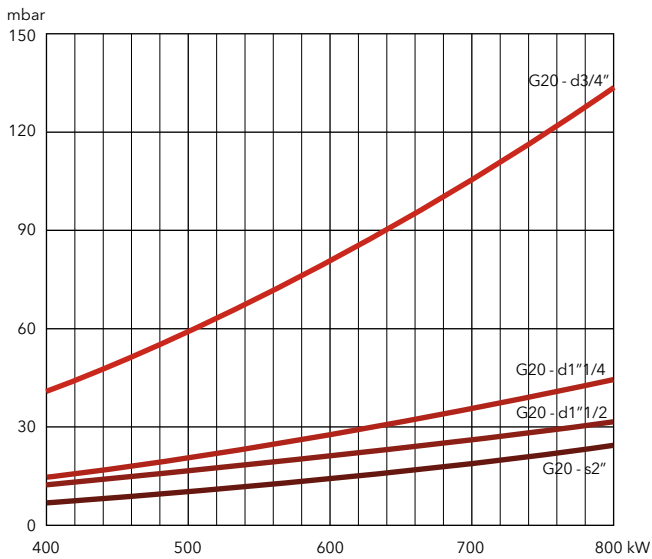

Natural gas G25

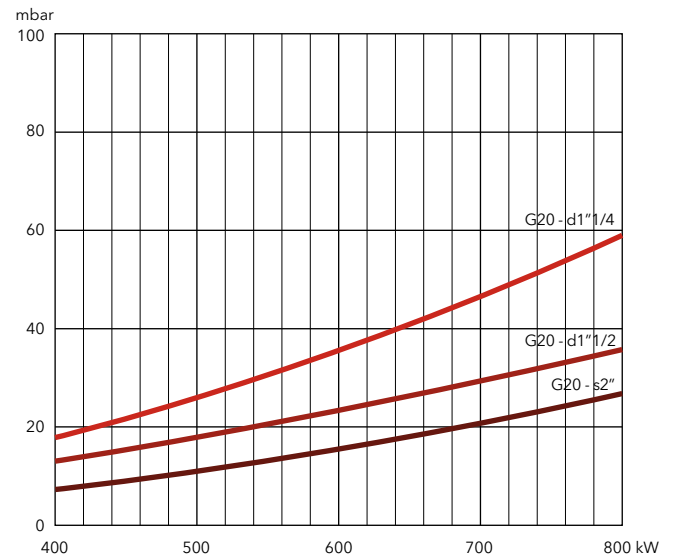



PRESSURE LOSS [BURNER HEAD + GAS TRAIN] (mbar)

VG5.750 DP

Burner output (kW)	LPG G31 Hi = 25,89 kWh/m ³			
	d3/4"-Rp1"	d1"1/4-Rp2"	d1"1/2-Rp2"	s2"-Rp2"
400	20	9	9	5
500	30	13	12	8
600	42	18	16	12
700	56	23	20	16
800	73	30	25	20

LPG

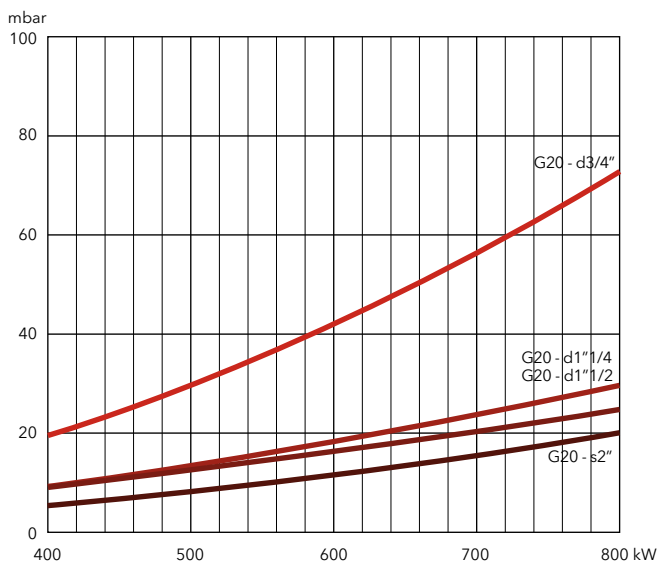

VG5.950 DP / VG5.1200 DP

170 ... 1160 kW

Two stage progressive/modulating pneumatic

- **Fuels:** natural gas (G20/G25, $H_u = 8,83...10,35 \text{ kWh/m}^3$); LPG (G31, $H_u = 25,89 \text{ kWh/m}^3$)
- **Emissions:** NOx < 70 mg/kWh (NCV), Low NOx class 3 burners according to EN676
- **Operation:** two stage progressive or modulating with the installation of a power regulator and dedicated probes (see page 218)
- **Protection level:** IP 21



TECHNICAL DATA

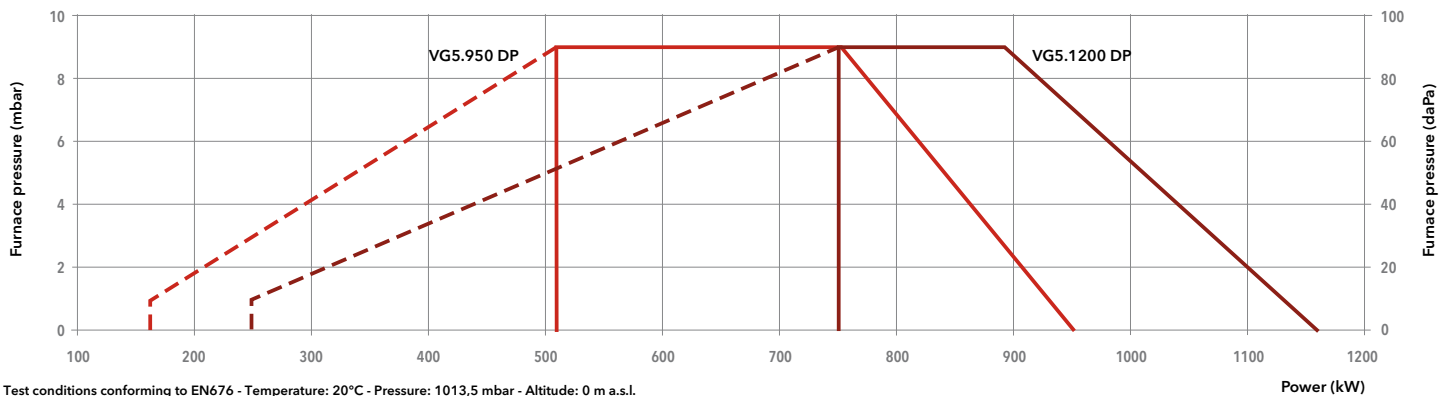

Model	VG5.950 DP			VG5.1200 DP		
Operation range	(170)510 – 950 kW			(250)750 – 1160 kW		
Gas pressure	20 – 300 mbar			20 – 300 mbar		
Control box / flame detection	TCG 5.. / ionization			TCG 5.. / ionization		
Fan motor	230/400 V – 50 Hz – 1,5 kW			230/400 V – 50 Hz – 1,5 kW		
Electrical consumption	65 + 1884 W			67 + 2052 W		
Acoustic level (LpA)	77 dB(A)			77 dB(A)		
CE certificate	1312 CN 5684			1312 CN 5684		
Head length	KN	KL	KM	KN	KL	KM
Complete burner code	VGD 40-065 s65-DN65	-	-	3833603	3833604	3833629
	VGD 20-5011 s2"-Rp2"	3833595	3833596	3833597	3833598	3833631
	MB-VEF 420 d1"1/2-Rp2"	3833585	3833586	3833623	3833589	3833633
	MB-VEF 412 d1"1/4-Rp2"	3833579	3833580	3833625	3833581	3833635
	MB-VEF 407 d3/4"-Rp1"	3833583	3833584	3833627	-	-

OTHER AVAILABLE VERSIONS

- 60 60 Hz version
- TC Version with tightness control
- V_{vent} Versions for continuous ventilation and post-ventilation

SCOPE OF SUPPLY

The burner is delivered in its package complete with:

- 1 burner head with flange seal and securing screws
- 1 compact gas train with gas filter; the gas filter is built-in for threaded valves (up to 2") and separated for flanged ones (DN65/80/100)
- 1 bag containing installation fittings
- 1 bag containing technical documentation (instruction manual, technical data, electrical diagram, exploded view and spare parts list)

DIMENSIONS (mm)

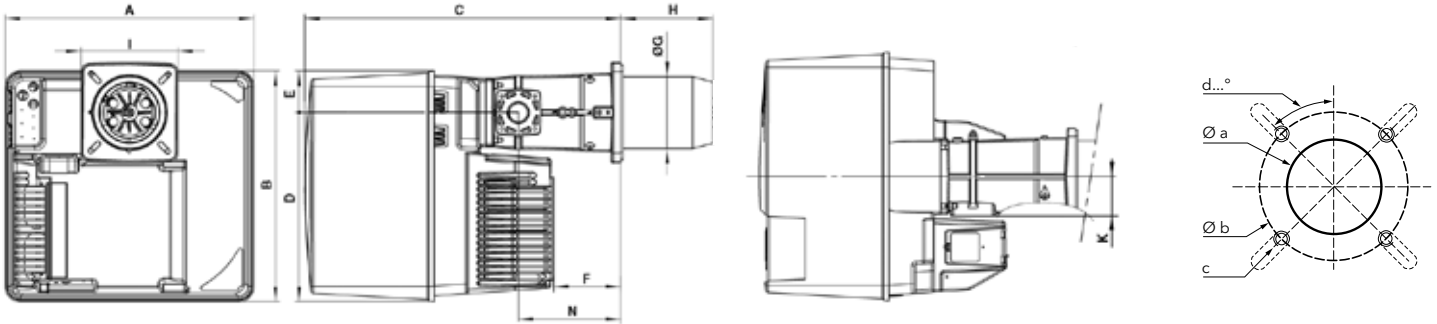

A	B	C	D	E	F	ØG	H			I	K	N
							KN	KM	KL			
581	549	752	450	99	164	170	285	395	505	230x238	89	244

Øa (mm)	b (mm)	c	d
195	220-260	M10	45°

Gas trains

Gas train "d":

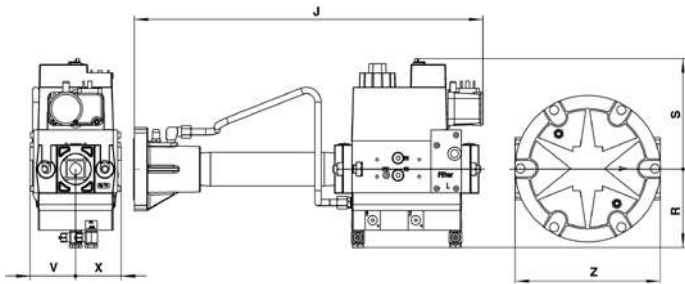

Model	J	R	S	V	X	Z
d1"1/2-Rp2"	540	123	190	55	55	-
d1"1/4-Rp2"	450	100	141	58	58	186
d3/4"-Rp1"	420	100	122	55	50	160

Gas train "s":

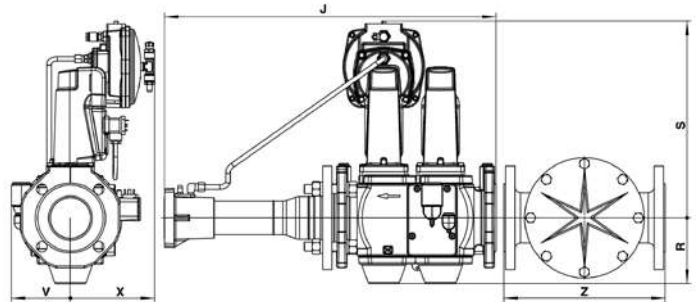

Model	J	R	S	V	X	Z
s65-DN65	600	135	360	110	150	290
s2"-Rp2"	612	103	330	110	150	186

PACKAGING

The burner is delivered on a pallet in three packages containing:

- burner housing
- combustion head
- gas train and filter

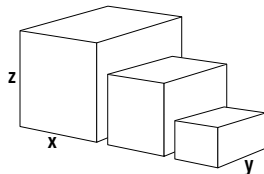

Component		Dimensions (mm)			Gross weight (kg)	
		X	Y	Z		
Burner body		800	600	850	54	
	Combustion head	KN	780	265	280	12,3
		KL	1010	265	280	14,4
Gas train	KM	1010	265	280	13,4	
	s65-DN65	790	600	500	29	
	s2"-Rp2"	790	600	500	17,2	
	d1"1/2-Rp2"	670	550	380	12	
	d1"1/4-Rp2"	600	400	240	12	
d3/4"-Rp1"	600	400	240	7		

VG5.950 DP / VG5.1200 DP

170 ... 1160 kW

Two stage progressive/modulating pneumatic

PRESSURE LOSS [BURNER HEAD + GAS TRAIN] (mbar)

VG5.950 DP

Burner output (kW)	Natural gas G20 Hi = 10,35 kWh/m ³				Natural gas G25 Hi = 8,83 kWh/m ³				LPG G31 Hi = 25,89 kWh/m ³			
	d3/4"-Rp1"	d1"1/4-Rp2"	d1"1/2-Rp2"	s2"-Rp2"	d3/4"-Rp1"	d1"1/4-Rp2"	d1"1/2-Rp2"	s2"-Rp2"	d3/4"-Rp1"	d1"1/4-Rp2"	d1"1/2-Rp2"	s2"-Rp2"
550	104	32	10	7	157	46	13	10	47	16	9	9
600	122	38	11	9	186	54	16	12	56	19	11	11
650	145	45	13	11	219	64	19	14	66	22	13	13
700	168	52	15	12	253	74	22	16	76	25	14	14
750	193	60	18	14	292	85	25	18	88	28	16	16
800	219	68	21	16	-	96	29	21	99	32	19	19
850	248	77	24	18	-	109	33	24	112	37	21	21
900	277	86	27	20	-	122	36	27	126	41	24	24
950	308	95	29	23	-	136	40	30	141	46	27	27

Natural gas G20

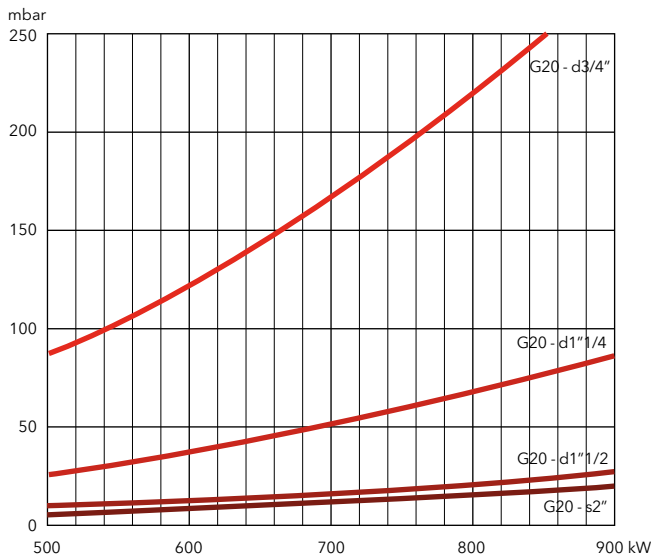

Natural gas G25

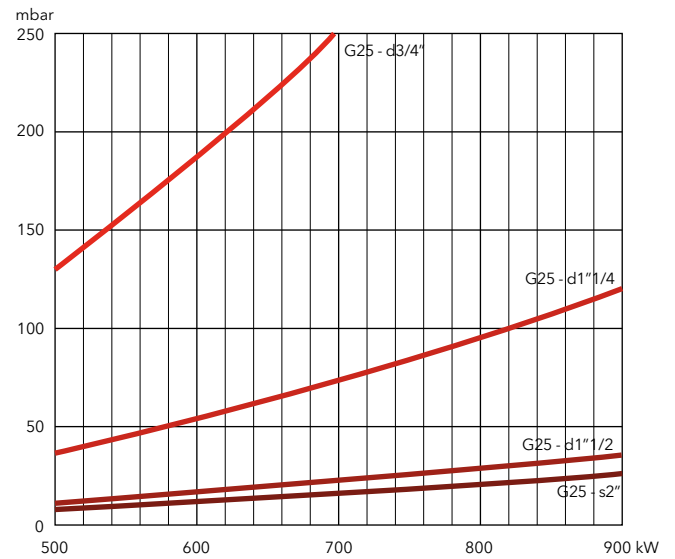

LPG

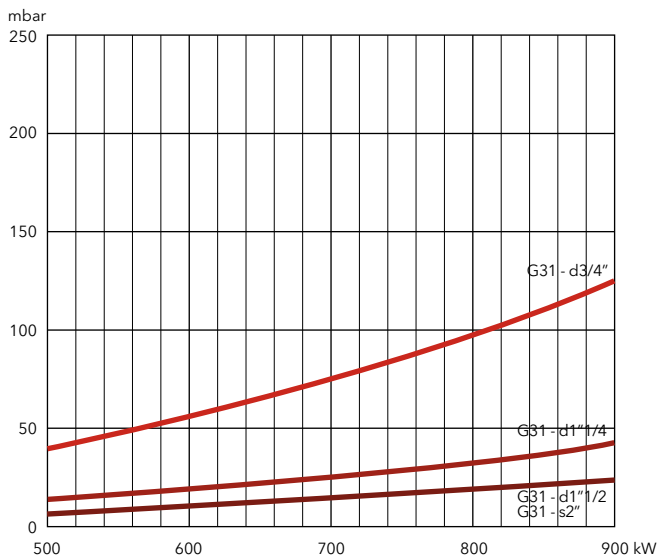



PRESSURE LOSS [BURNER HEAD + GAS TRAIN] (mbar)

VG5.1200 DP

Burner output (kW)	Natural gas G20 Hi = 10,35 kWh/m ³				Natural gas G25 Hi = 8,83 kWh/m ³				LPG G31 Hi = 25,89 kWh/m ³		
	d1"1/4-Rp2"	d1"1/2-Rp2"	s2"-Rp2"	s65-Rp2"	d1"1/4-Rp2"	d1"1/2-Rp2"	s2"-Rp2"	s65-Rp2"	d1"1/4-Rp2"	d1"1/2-Rp2"	s2"-Rp2"
750	56	18	14	12	82	24	19	14	28	14	14
800	65	21	16	13	92	27	22	16	32	16	16
850	74	24	18	15	105	30	25	18	36	18	18
900	83	27	20	17	118	33	28	20	41	20	20
950	94	30	22	19	131	37	31	23	46	22	22
1000	103	33	25	21	145	42	34	26	51	24	25
1050	113	37	27	23	160	47	38	28	56	27	27
1100	124	40	30	25	175	51	42	31	61	30	30
1150	136	44	33	27	192	55	46	34	67	33	33

Natural gas G20

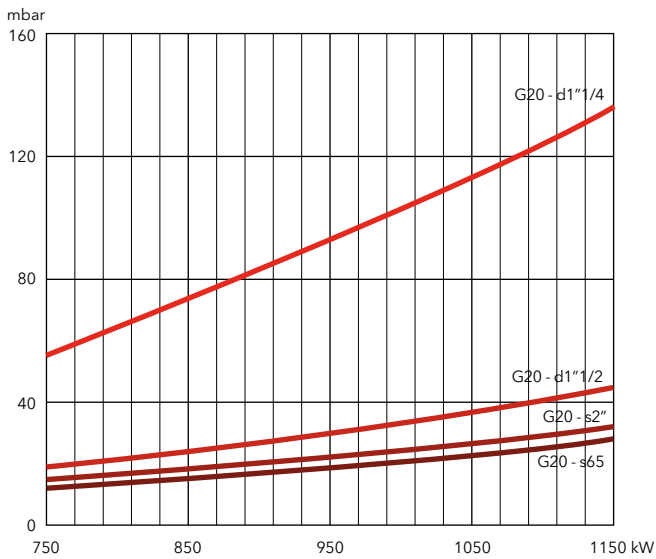

Natural gas G25

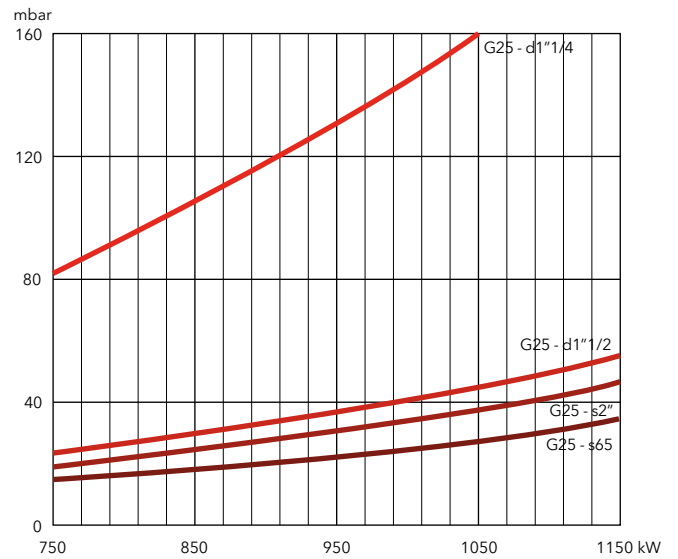

LPG

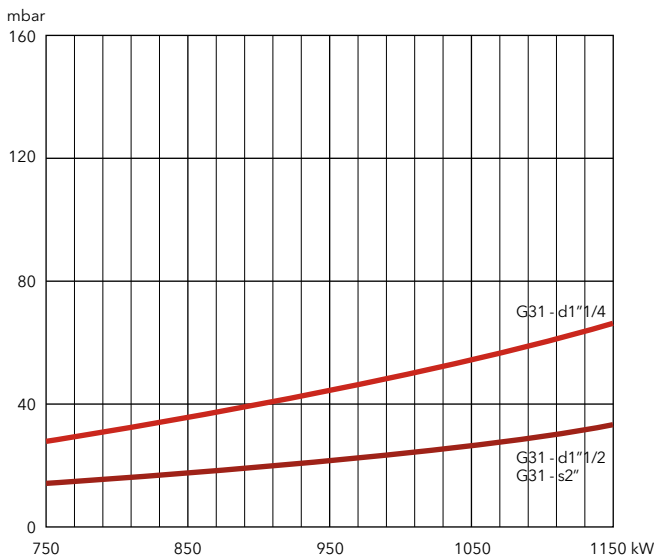

VG6.1600 DP / VG6.2100 DP

300 ... 1900 kW

Two stage progressive/modulating pneumatic



- **Fuels:** natural gas (G20/G25, $H_u = 8,83...10,35 \text{ kWh/m}^3$); LPG (G31, $H_u = 25,89 \text{ kWh/m}^3$)
- **Emissions:** $\text{NO}_x < 70 \text{ mg/kWh}$ (NCV), Low NO_x class 3 burners according to EN676
- **Operation:** two stage progressive or modulating with the installation of a power regulator and dedicated probes (see page 218)
- **Protection level:** IP 21

TECHNICAL DATA

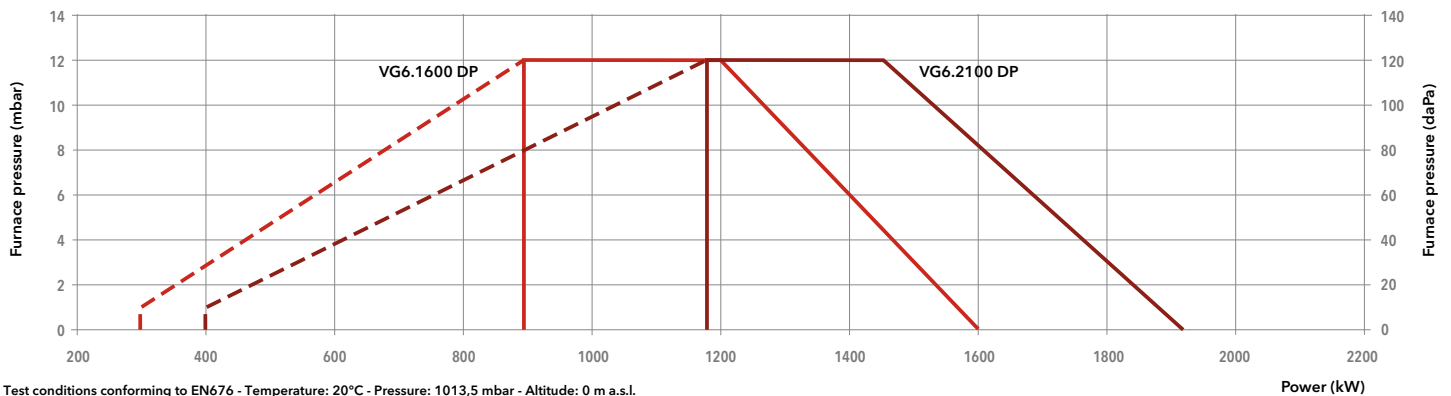

Model	VG6.1600 DP /TC			VG6.2100 DP /TC			
Operation range	(300) 890 - 1600 kW			(400) 1180 - 1900 kW			
Gas pressure	20 - 300 mbar			20 - 300 mbar			
Control box / flame detection	TCG 5.. / IRD 1020.1			TCG 5.. / IRD 1020.1			
Fan motor	230/400 V - 50 Hz - 2,2 kW			230/400 V - 50 Hz - 2,5 kW			
Electrical consumption	76 + 2325 W			74 + 2622 W			
Acoustic level (LpA)	77,2 dB(A)			79 dB(A)			
CE certificate	1312 CN 5685			1312 CN 5685			
Head length	KN	KL	KM	KN	KL	KM	
Complete burner code	VGD 40-080 s80-DN80/TC	-	-	-	3833757	3833758	3833759
	VGD 40-065 s65-DN65/TC	3833745	3833746	3833747	3833760	3833761	3833762
	VGD 20-5011 s2"-Rp2"/TC	3833748	3833749	3833750	3833763	3833764	3833765
	MB-VEF 420 d1"1/2-Rp2"/TC	3833751	3833752	3833753	3833766	3833767	3833768
	MB-VEF 412 d1"1/4-Rp2"/TC	3833754	3833755	3833756	3833769	3833770	3833771

OTHER AVAILABLE VERSIONS

60 60 Hz version

V_{ent} Versions for continuous ventilation and post-ventilation

SCOPE OF SUPPLY

The burner is delivered in its package complete with:

- 1 burner head with flange seal and securing screws
- 1 compact gas train with gas filter; the gas filter is built-in for threaded valves (up to 2") and separated for flanged ones (DN65/80/100)
- 1 bag containing installation fittings
- 1 bag containing technical documentation (instruction manual, technical data, electrical diagram, exploded view and spare parts list)

DIMENSIONS (mm)

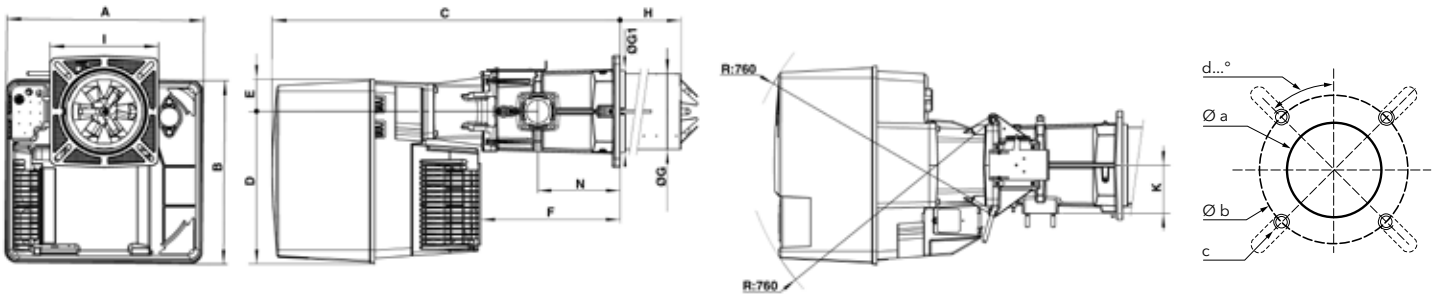

A	B	C	D	E	F	ØG	ØG1	H			I	K	N
								KN	KM	KL			
592	553	1050	456	97	421	227	245	310	410	510	326x335	144	247

Øa (mm)	b (mm)	c	d
250	300-400	M12	45°

Gas trains

Gas train "d":

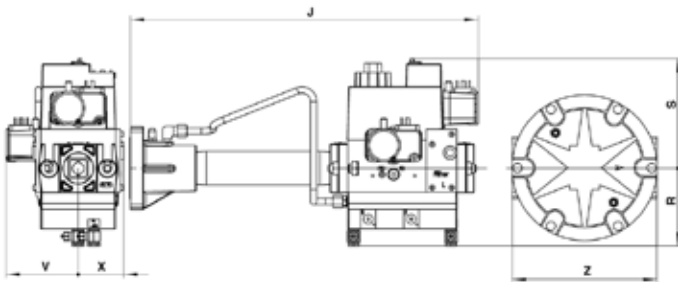

Model	J	R	S	V	X	Z
d1"1/2-Rp2"/TC	540	123	190	95	55	-
d1"1/4-Rp2"/TC	450	100	141	95	58	186

Gas train "s":

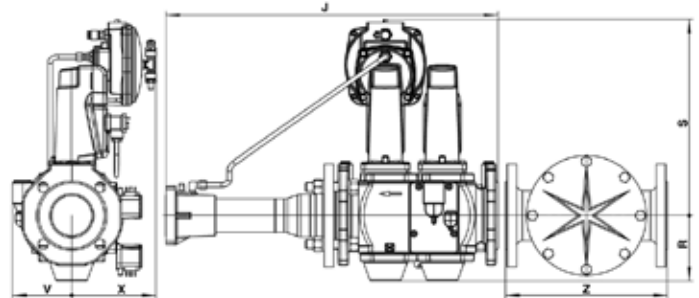

Model	J	R	S	V	X	Z
s80-DN80/TC	600	120	350	110	150	320
s65-DN65/TC	600	135	360	110	150	290
s2"-Rp2"/TC	612	103	330	110	150	186

PACKAGING

The burner is delivered on a pallet in three packages containing:

- burner housing
- combustion head
- gas train and filter

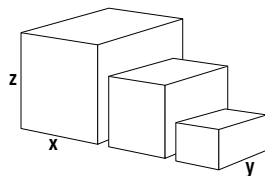

Component		Dimensions (mm)			Gross weight (kg)
		X	Y	Z	
Burner body	VG6.1600 DP	800	600	850	67,8
	VG6.2100 DP	800	600	850	69,2
Combustion head	KN	1000	380	420	26,7
	KL	1100	380	430	29,4
	KM	1100	380	430	28
Gas train	s80-DN80/TC	790	600	500	39
	s65-DN65/TC	790	600	500	29,4
	s2"-Rp2"/TC	790	600	500	16,5
	d1"1/2-Rp2"/TC	670	550	380	14,3
	d1"1/4-Rp2"/TC	670	550	380	13

VG6.1600 DP / VG6.2100 DP

300 ... 1900 kW

Two stage progressive/modulating pneumatic

PRESSURE LOSS [BURNER HEAD + GAS TRAIN] (mbar)

VG6.1600 DP

Burner output (kW)	Natural gas G20 Hi = 10,35 kWh/m ³				Natural gas G25 Hi = 8,83 kWh/m ³				LPG G31 Hi = 25,89 kWh/m ³		
	d1"1/4-Rp2"	d1"1/2-Rp2"	s2"-Rp2"	s65-DN65	d1"1/4-Rp2"	d1"1/2-Rp2"	s2"-Rp2"	s65-DN65	d1"1/4-Rp2"	d1"1/2-Rp2"	s2"-Rp2"
900	53	18	9	7	77	27	14	9	20	8	6
1000	66	23	12	8	93	33	17	12	24	10	7
1100	80	28	14	10	113	40	21	14	29	12	9
1200	95	33	17	12	136	48	25	17	35	15	10
1300	112	39	20	14	158	57	29	20	41	17	12
1400	129	45	23	16	182	66	34	23	47	20	14
1500	148	51	26	19	209	76	39	27	54	23	16
1600	168	58	30	21	238	86	45	30	62	26	19

Natural gas G20

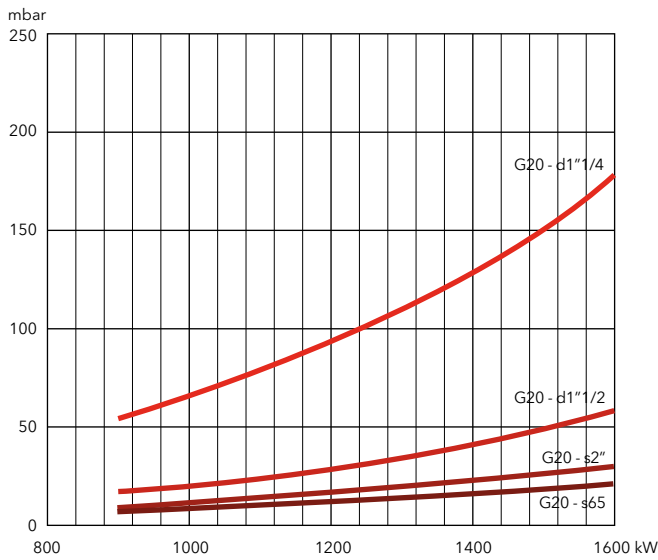

Natural gas G25

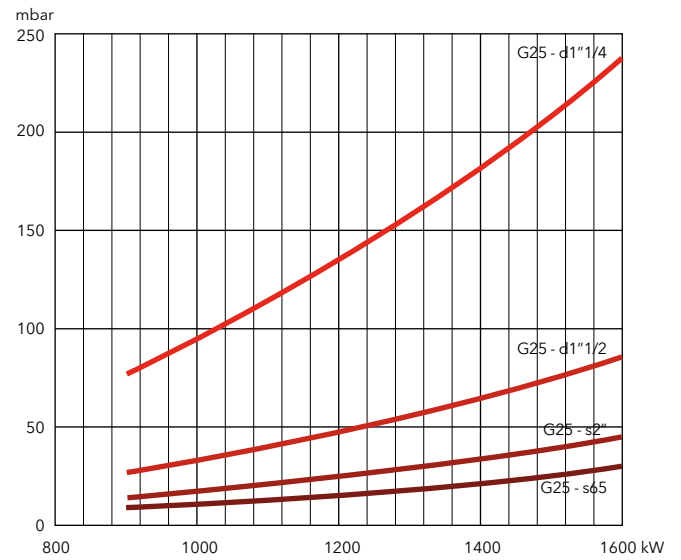

LPG

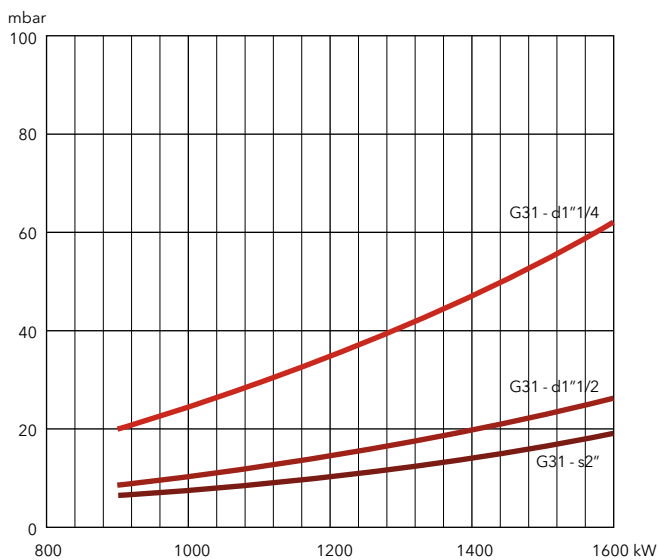



PRESSURE LOSS [BURNER HEAD + GAS TRAIN] (mbar)

VG6.2100 DP

Burner output (kW)	Natural gas G20 Hi = 10,35 kWh/m ³					Natural gas G25 Hi = 8,83 kWh/m ³					LPG G31 Hi = 25,89 kWh/m ³		
	d1"1/4-Rp2	d1"1/2-Rp2	s2"-Rp2"	s65-DN65	s80-DN80	d1"1/4-Rp2	d1"1/2-Rp2	s2"-Rp2"	s65-DN65	s80-DN80	d1"1/4-Rp2	d1"1/2-Rp2	s2"-Rp2"
1200	70	28	17	12	10	81	32	20	14	12	39	13	8
1300	82	32	20	14	12	95	38	24	16	14	46	15	10
1400	95	37	24	16	14	110	44	28	19	16	53	17	11
1500	109	43	27	18	16	128	50	32	21	19	61	20	13
1600	124	49	31	21	18	144	57	36	24	21	69	23	15
1700	140	55	35	24	21	163	64	40	27	24	78	26	17
1800	157	61	39	26	23	183	71	45	30	27	87	29	19
1900	175	69	43	29	25	204	79	50	34	31	97	32	21

Natural gas G20

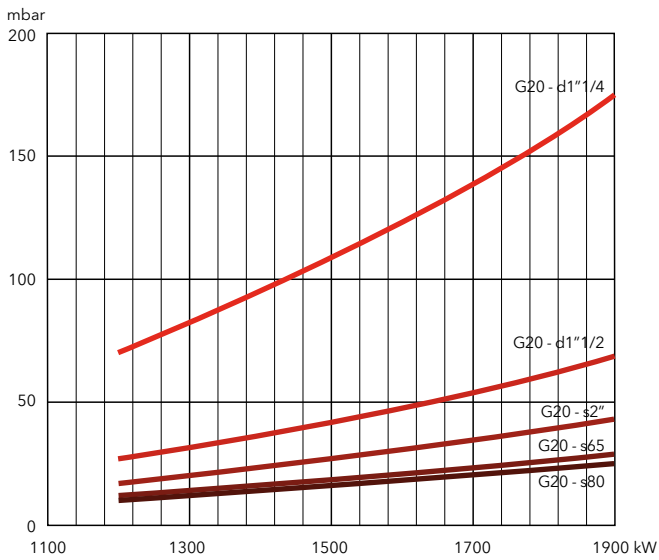

Natural gas G25

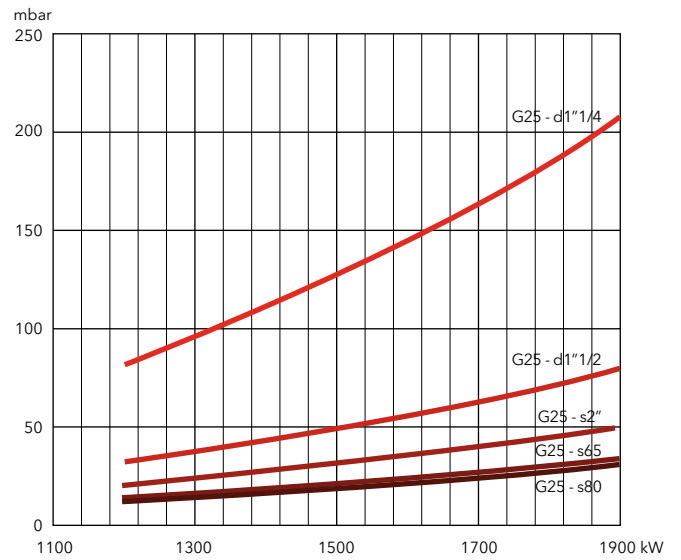

LPG

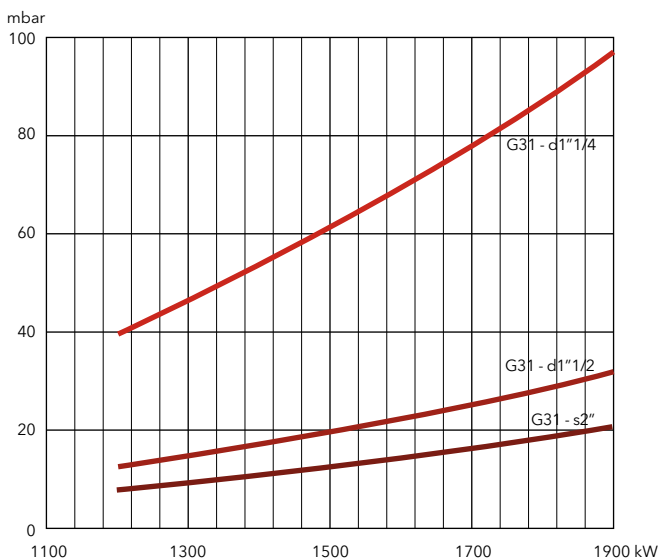

VG2.205 V E

65 ... 205 kW

2 stage progressive/modulating pneumatic + fan speed control

- **Fuels:** natural gas (G20/G25, $H_u = 8,83...10,35 \text{ kWh/m}^3$); LPG (G31, $H_u = 25,89 \text{ kWh/m}^3$)
- **Emissions:** $\text{NO}_x < 56 \text{ mg/kWh}$ (GCV), burners compliant with ErP Directive
- **Operation:** two stage progressive or modulating with the installation of a power regulator and dedicated probes (see page 218) and fan speed control
- **Protection level:** IP 21



TECHNICAL DATA

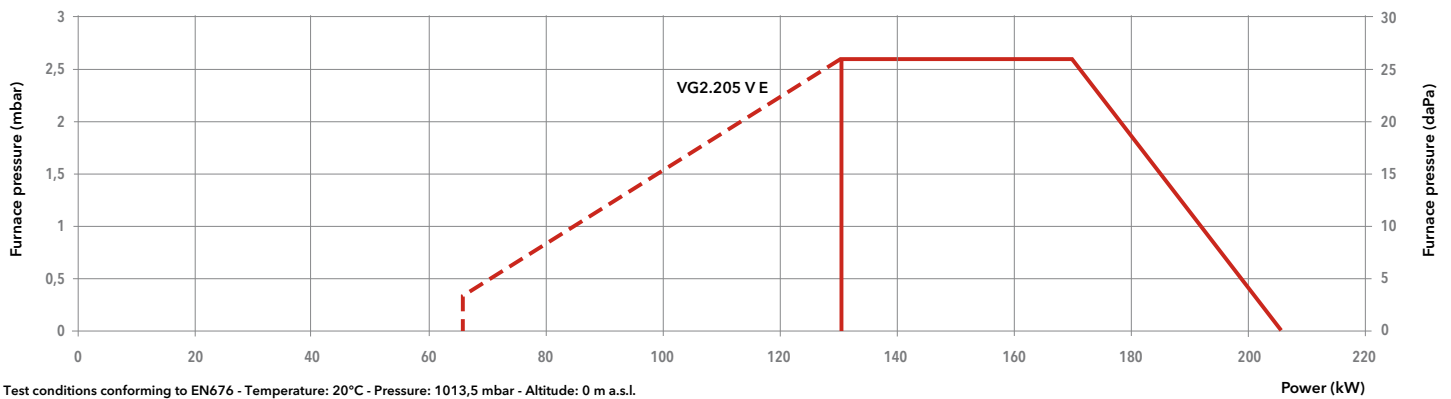

Model	VG2.205 V E	
Operation range	(65) 130 - 205 kW	
Gas pressure	20 - 40 mbar for MB-VEF 412; 40 - 100 mbar for d345; 100 - 360 mbar for d346	
Control box / flame detection	TCG5.../ionization	
Fan motor	230 V - 50 Hz - 250 W	
Electrical consumption (max/min/stand-by)	302 W / 267 W / 4 W	
Acoustic level (LpA)	65 dB(A)	
CE certificate	0476 CT 2423	
Head length	KN	KL
Complete burner code	MB-VEF 412 d1"1/4-Rp1"1/4 3836436 MB-VEF 407 d345-3/4"-Rp3/4" 3836438 MB-VEF 407 d346-3/4"-Rp3/4" 3836440	3836437 3836439 3836441

OTHER AVAILABLE VERSIONS

Versions for continuous ventilation and post-ventilation

SCOPE OF SUPPLY

The burner is delivered in its package complete with:

- 1 gas connection flange
- 1 compact gas train with gas filter; the gas filter is built-in for threaded valves (up to 2") and separated for flanged ones (DN65/80/100)
- 1 burner flange with insulation
- 1 bag containing installation fittings
- 1 bag containing technical documentation (instruction manual, technical data, electrical diagram, exploded view and spare parts list)



DIMENSIONS (mm)

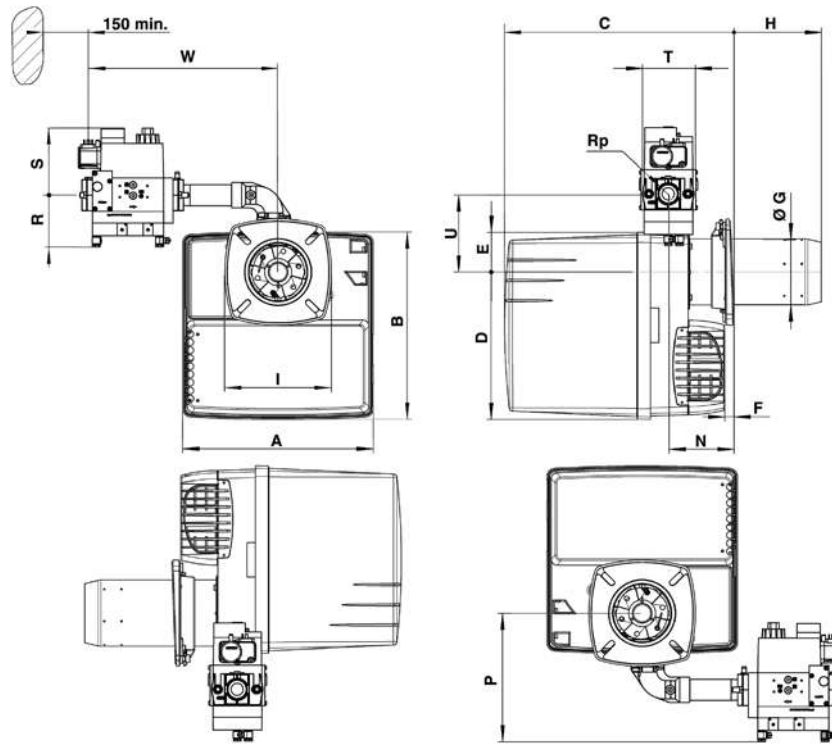

Gas train model	A	B	C		D	E	F min	ØG	H		I	N min	P	Rp	R	S	T	U	W
			KN	KL					KN	KL									
d1"1/4-Rp1"1/4	331	325	398...518	398...638	256	69	15	125	30...150	30...270	185	113	188	1"1/4	80	175	145	133	380
d3/4"-Rp3/4"	331	325	398...518	398...638	256	69	15	125	30...150	30...270	185	113	179	3/4"	70	160	120	133	345

Connecting flange

Øa (mm)	b (mm)	c	d
130-145	160-185	M8	45°

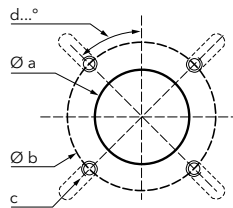

PACKAGING

The burner is delivered in a single package containing all the components

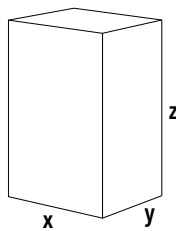

Burner	Dimensions (mm)			Gross weight (kg)
	X	Y	Z	
VG2.205	400	400	760	26

VG3.290 V E / VG3.350 V E

95 ... 350 kW

Two stage progressive/modulating pneumatic + fan speed control

- **Fuels:** natural gas (G20/G25, $H_u = 8,83...10,35 \text{ kWh/m}^3$); LPG (G31, $H_u = 25,89 \text{ kWh/m}^3$)
- **Emissions:** $\text{NO}_x < 56 \text{ mg/kWh}$ (GCV), burners compliant with ErP Directive
- **Operation:** two stage progressive or modulating with the installation of a power regulator and dedicated probes (see page 218) and fan speed control
- **Protection level:** IP 21



TECHNICAL DATA

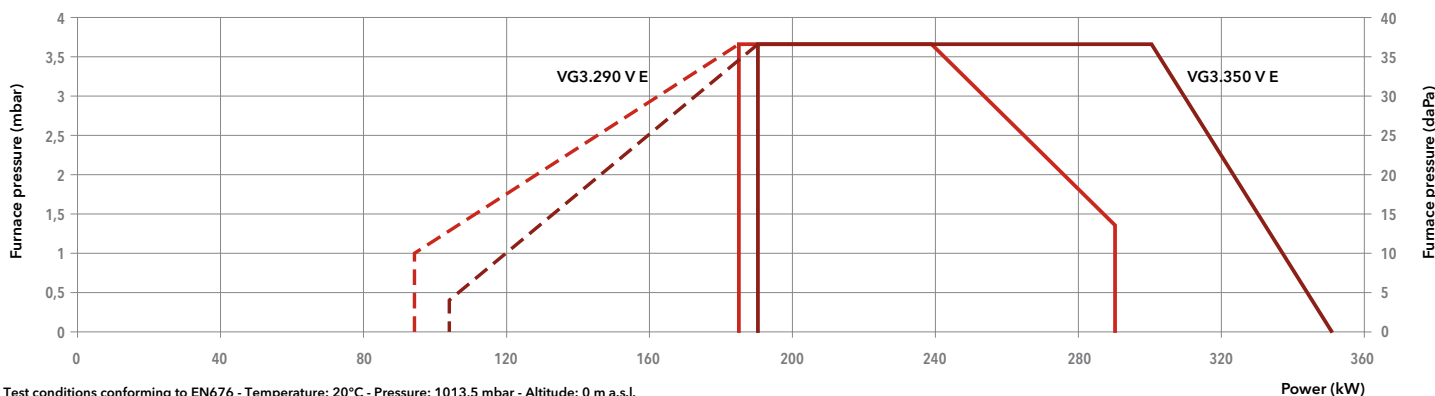

Model	VG3.290 V E		VG3.350 V E	
Operation range	(95) 185 - 290 kW		(105) 190 - 350 kW	
Gas pressure	20 - 360 mbar		20 - 360 mbar	
Control box / flame detection	TCG5... / ionization		TCG5... / ionization	
Fan motor	230 V - 50 Hz - 250 W		230 V - 50 Hz - 300 W	
Electrical consumption (max/min/stand-by)	465 W / 441 W / 4 W		583 W / 583 W / 4 W	
Acoustic level (LpA)	67 dB(A)		69 dB(A)	
CE certificate	0476 CT 2423		0476 CT 2423	
Head length	KN	KL	KN	KL
Complete burner code	MB-VEF 420 d1"1/2-Rp2"	-	3836446	3836447
	MB-VEF 412 d1"1/4-Rp1"1/4"	3836442	3836448	3836449
	MB-VEF 407 d3/4"-Rp1"	3836444	3836445	3836450

OTHER AVAILABLE VERSIONS

- TC** Version with tightness control
- Vent** Versions for continuous ventilation and post-ventilation

SCOPE OF SUPPLY

The burner is delivered in its package complete with:

- 1 burner head with flange seal and securing screws
- 1 compact gas train with gas filter; the gas filter is built-in for threaded valves (up to 2") and separated for flanged ones (DN65/80/100)
- 1 bag containing installation fittings
- 1 bag containing technical documentation (instruction manual, technical data, electrical diagram, exploded view and spare parts list)



DIMENSIONS (mm)

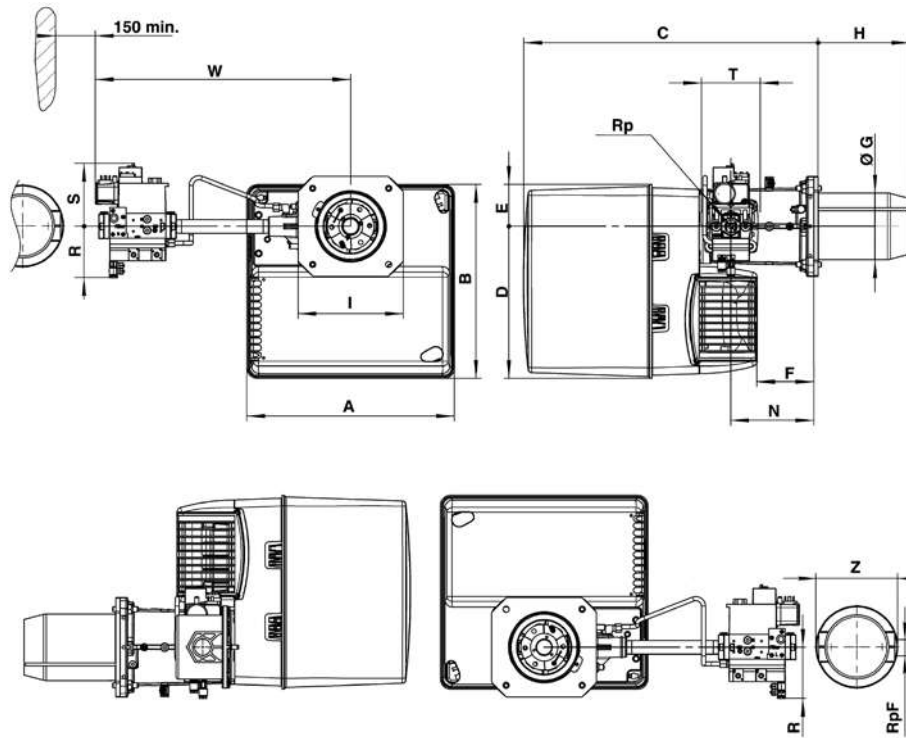

Gas train model	A	B	C	D	E	F	ØG	H		I	N	Rp	R	S	T	W	RpF	Z
								KN	KL									
d1"1/2-Rp2"	406	379	576	297	82	120	130	180	320	195x205	170	2"	100	185	100	603	-	-
d1"1/4-Rp1"1/4	406	379	576	297	82	120	130	180	320	195x205	170	1"1/4	80	175	145	526	-	-
d3/4"-Rp1"	406	379	576	297	82	120	130	180	320	195x205	170	1"	70	160	120	479	1"	160

Connecting flange

Øa (mm)	b (mm)	c	d
155-190	175-220	M10	45°

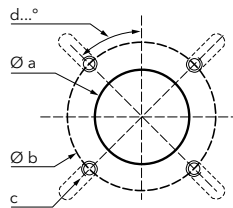

PACKAGING

The burner is delivered on a pallet in three packages containing:

- burner housing
- combustion head
- gas train and filter

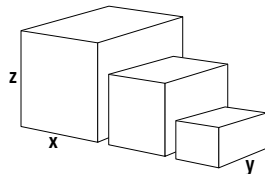

Component		Dimensions (mm)			Gross weight (kg)
		X	Y	Z	
Burner body	VG3.290 V E	440	400	520	21
	VG3.350 V E	440	400	520	22
Combustion head	KN	650	210	260	6
	KL	780	210	260	7
Gas train	d1"1/2-Rp2"	670	550	380	12
	d1"1/4-Rp1"1/4	600	400	240	11
	d3/4"-Rp1"	600	400	240	7

VG3.290 V E / VG3.350 V E

95 ... 350 kW

Two stage progressive/modulating pneumatic + fan speed control

PRESSURE LOSS [BURNER HEAD + GAS TRAIN] (mbar)

VG3.290 V E

Burner output (kW)	Natural gas G20 Hi = 10,35 kWh/m ³		Natural gas G25 Hi = 8,83 kWh/m ³		LPG G31 Hi = 25,89 kWh/m ³	
	d3/4"-Rp1"	d1"1/4-Rp1"1/4	d3/4"-Rp1"	d1"1/4-Rp1"1/4	d3/4"-Rp1"	d1"1/4-Rp1"1/4
190	17	9	22	11	11	7
210	18	9	24	12	12	7
230	20	9	27	12	12	7
250	22	10	31	13	13	8
270	25	11	35	15	14	8
290	29	13	40	16	16	9

Natural gas G20

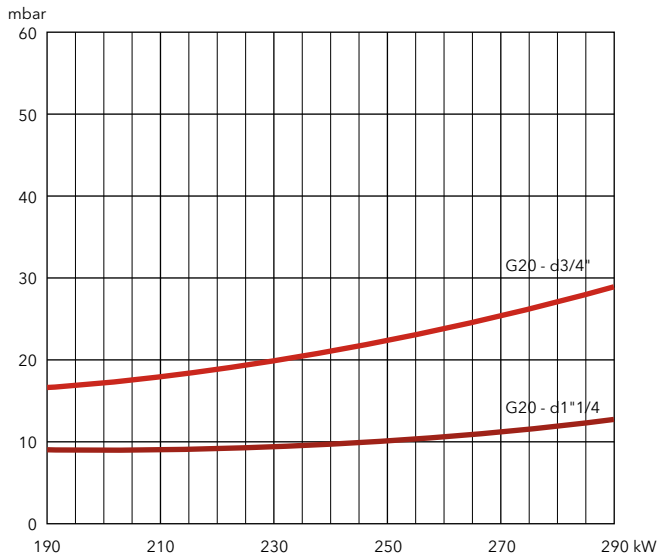

Natural gas G25

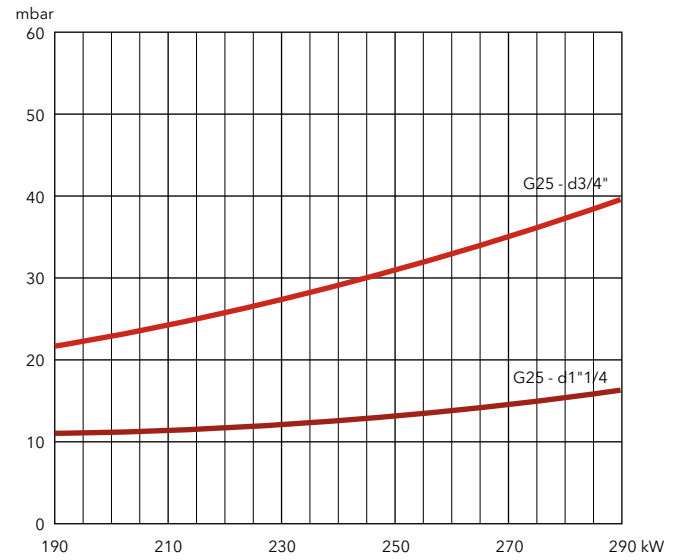

LPG

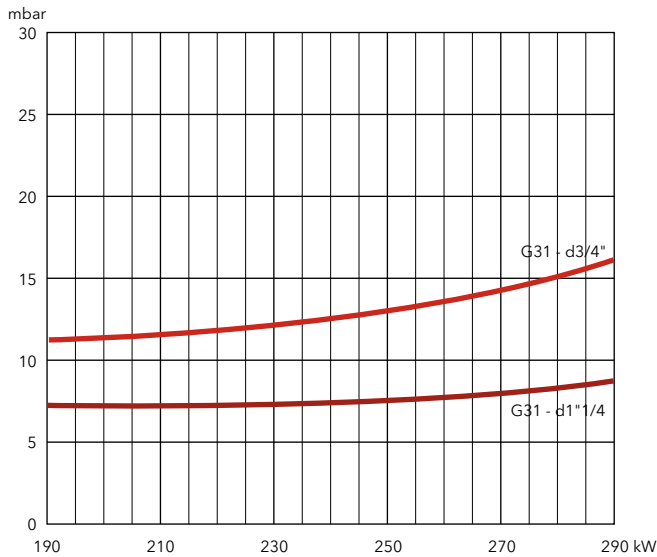



PRESSURE LOSS [BURNER HEAD + GAS TRAIN] (mbar)

VG3.350 V E

Burner output (kW)	Natural gas G20 Hi = 10,35 kWh/m ³			Natural gas G25 Hi = 8,83 kWh/m ³			LPG G31
	d3/4"-Rp1"	d1"1/4-Rp1"1/4	d1"1/2-Rp2"	d3/4"-Rp1"	d1"1/4-Rp1"1/4	d1"1/2-Rp2"	d3/4"-Rp1"
190	13	6	6	19	8	8	8
230	17	7	7	26	11	10	12
270	23	9	8	35	15	13	15
310	29	11	10	44	18	16	18
350	36	14	12	54	22	19	22

Natural gas G20

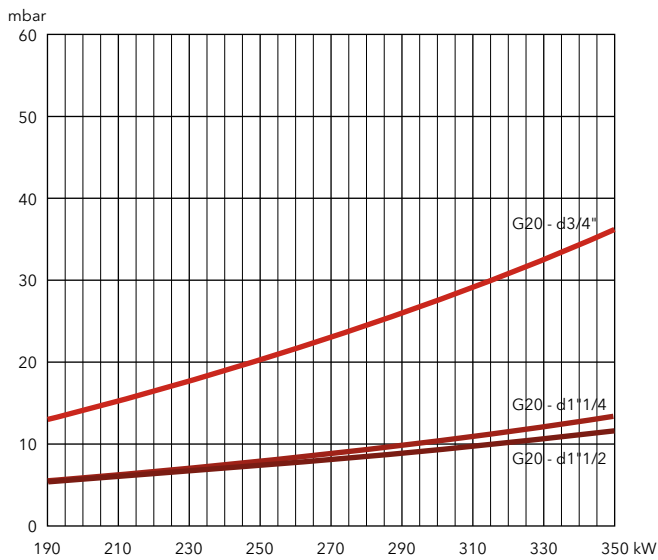

Natural gas G25

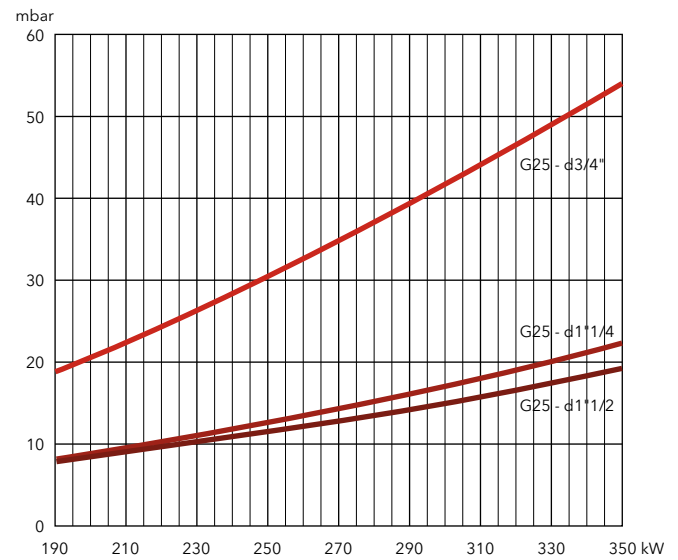

LPG

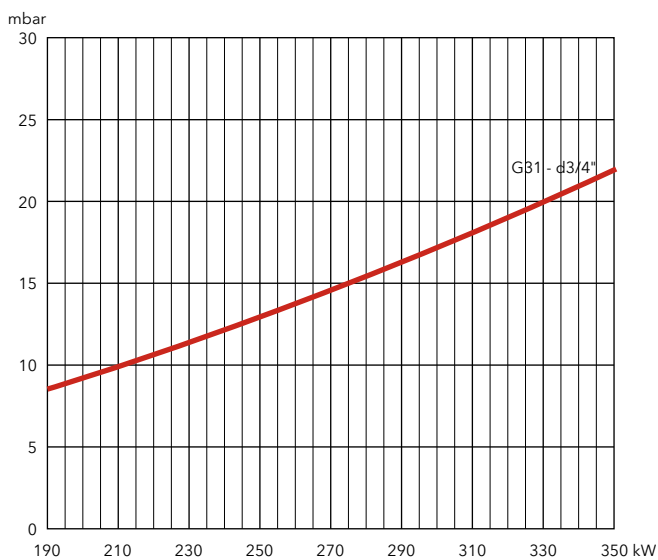

VG4.440 V E

110 ... 440 kW

Two stage progressive/modulating pneumatic + fan speed control



- **Fuels:** natural gas (G20/G25, $H_u = 8,83...10,35 \text{ kWh/m}^3$); LPG (G31, $H_u = 25,89 \text{ kWh/m}^3$)
- **Emissions:** $\text{NO}_x < 56 \text{ mg/kWh}$ (GCV), burners compliant with ErP Directive
- **Operation:** two stage progressive or modulating with the installation of a power regulator and dedicated probes (see page 218) and fan speed control
- **Protection level:** IP 21

TECHNICAL DATA

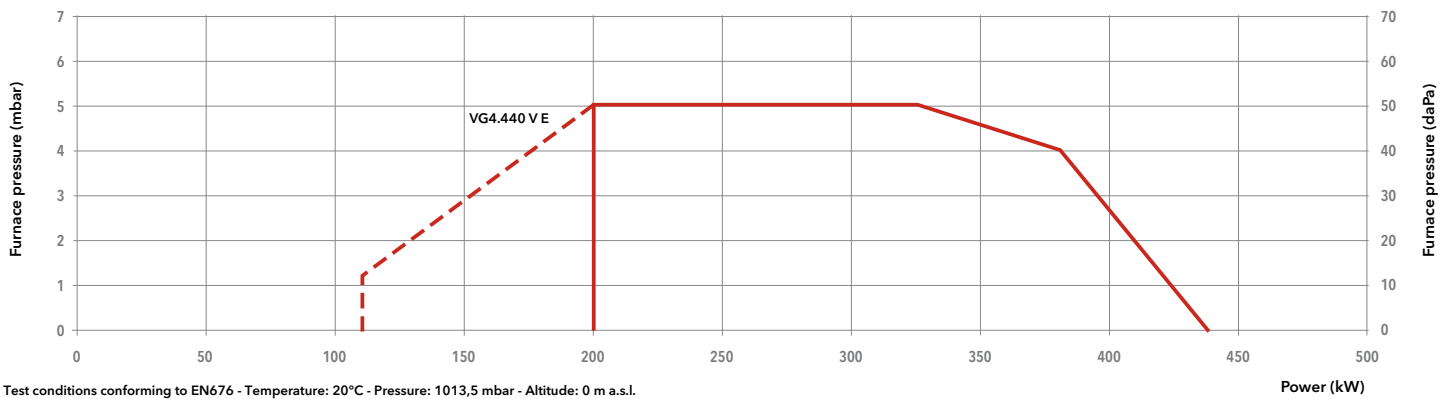

Model		VG4.440 V E	
Operation range		(110) 200 - 440 kW	
Gas pressure		20 - 360 mbar	
Control box / flame detection		TCG5.../ionization	
Fan motor		230 V - 50 Hz - 420 W	
Electrical consumption (max/min/stand-by)		606 W / 569 W / 4 W	
Acoustic level (LpA)		70 dB(A)	
CE certificate		0476 CT 2423	
Head length		KN	KL
Complete burner code	MB-VEF 420	d1"1/2-Rp2"	3836452
	MB-VEF 412	d1"1/4-Rp1"1/4	3836454
	MB-VEF 407	d3/4"-Rp1"	3836456
			3836453
			3836455
			3836457

OTHER AVAILABLE VERSIONS

- TC Version with tightness control
- Vent Versions for continuous ventilation and post-ventilation

SCOPE OF SUPPLY

The burner is delivered in its package complete with:

- 1 burner head with flange seal and securing screws
- 1 compact gas train with gas filter; the gas filter is built-in for threaded valves (up to 2") and separated for flanged ones (DN65/80/100)
- 1 bag containing installation fittings
- 1 bag containing technical documentation (instruction manual, technical data, electrical diagram, exploded view and spare parts list)



DIMENSIONS (mm)

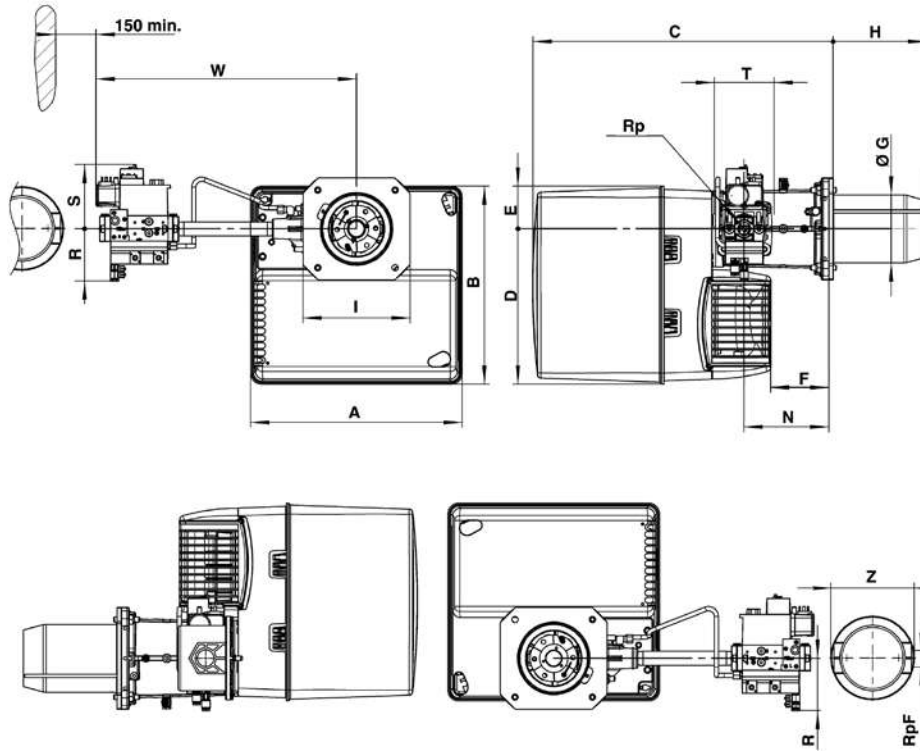

Gas train model	A	B	C	D	E	F	ØG	H		I	N	Rp	R	S	T	W	RpF	Z
								KN	KL									
d1"1/2-Rp2"	465	475	640	377	97	149	157	212	352	245	195	2"	100	185	150	536	-	-
d1"1/4-Rp1"1/4	465	475	640	377	97	149	157	212	352	245	195	1"1/4	80	175	151	489	-	-
d3/4"-Rp1"	465	475	640	377	97	149	157	212	352	245	195	1"	70	160	132	489	1"	160

Connecting flange

Øa (mm)	b (mm)	c	d
190-240	200-270	M10	45°

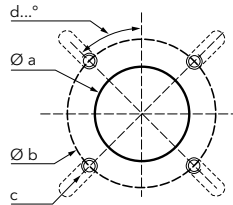

PACKAGING

The burner is delivered on a pallet in three packages containing:

- burner housing
- combustion head
- gas train and filter

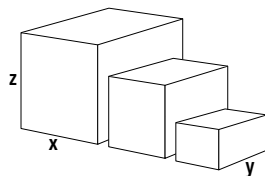

Component		Dimensions (mm)			Gross weight (kg)
		X	Y	Z	
Burner body	VG4.440 V E	490	490	590	28,6
	KN	750	260	295	8,9
Combustion head	KL	895	260	295	10,1
	d1"1/2-Rp2"	670	550	380	12
Gas train	d1"1/4-Rp1"1/4	600	400	240	11
	d3/4"-Rp1"	600	400	240	7

VG4.440 V E

110 ... 440 kW

Two stage progressive/modulating pneumatic + fan speed control

PRESSURE LOSS [BURNER HEAD + GAS TRAIN] (mbar)

VG4.440 V E

Burner output (kW)	Natural gas G20 Hi = 10,35 kWh/m ³			Natural gas G25 Hi = 8,83 kWh/m ³		
	d3/4"-Rp1"	d1"1/4-Rp1"1/4	d1"1/2-Rp2"	d3/4"-Rp1"	d1"1/4-Rp1"1/4	d1"1/2-Rp2"
240	19	8	7	27	11	10
280	24	9	8	35	13	11
320	30	11	9	42	15	12
360	37	13	11	51	18	15
400	44	15	13	64	22	17
440	51	18	15	78	25	20

Natural gas G20

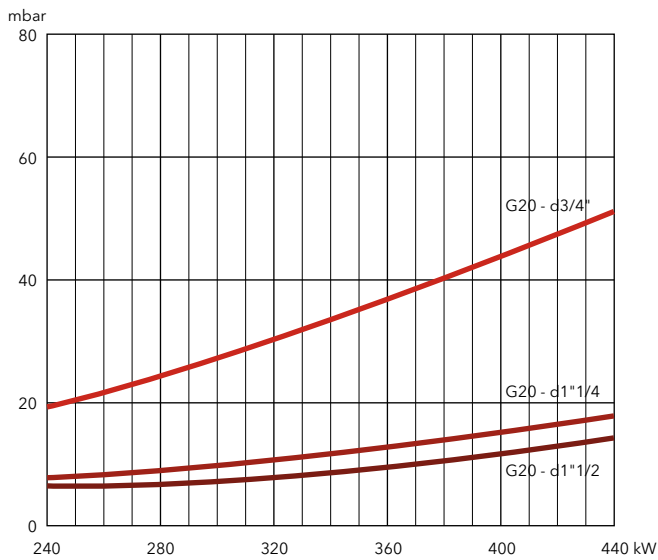

Natural gas G25

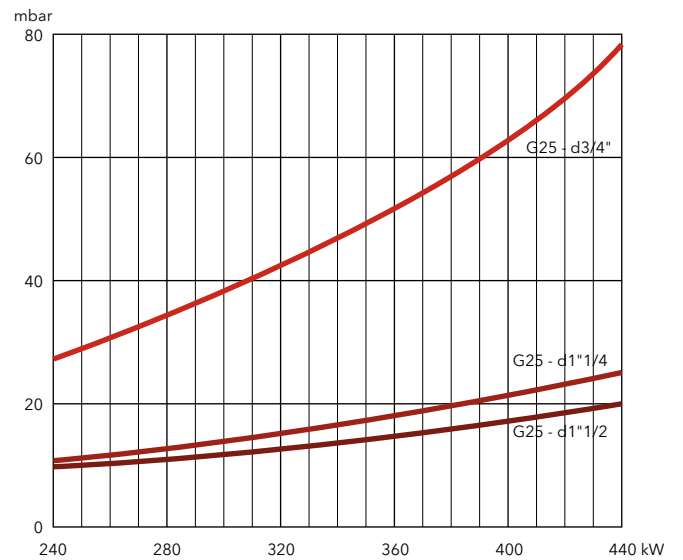



PRESSURE LOSS [BURNER HEAD + GAS TRAIN] (mbar)

Burner output (kW)	LPG G31 Hi = 25,89 kWh/m ³	
	d3/4"-Rp1"	d1"1/4-Rp1"1/4
240	13	8
280	16	9
320	18	10
360	22	11
400	26	13
440	32	16

LPG

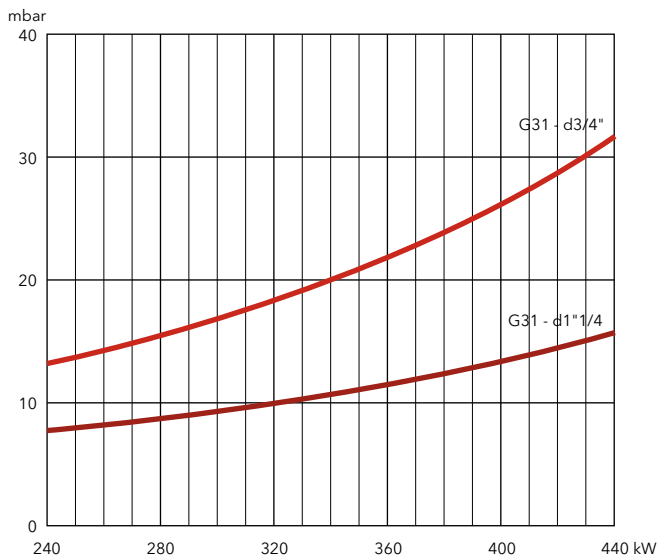

VG4.460 V / VG4.610 V

100 ... 610 kW

Two stage progressive/modulating pneumatic + fan speed control

- **Fuels:** natural gas, net calorific value 8,83...10,35 kWh/m³;
LPG, net calorific value 25,89 kWh/m³
- **Emissions:** NOx < 70 mg/kWh (NCV), Low NOx class 3 burners according to EN676
- **Operation:** two stage progressive or modulating with the installation of a power regulator and dedicated probes (see page 218) and fan speed control
- **Protection level:** IP 41



TECHNICAL DATA

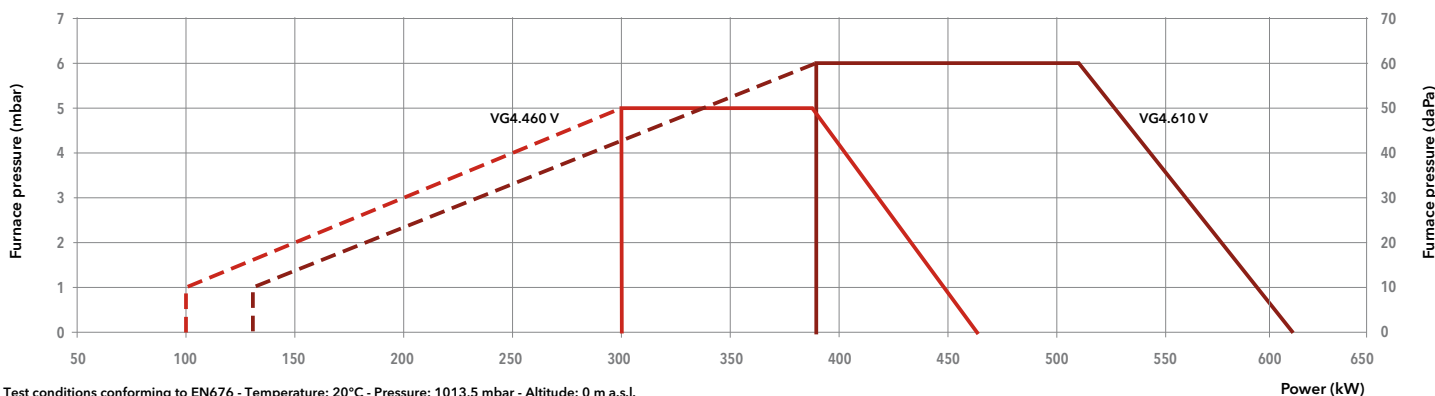

Model	VG 4.460 V		VG 4.610 V	
Operation range	(100) 300 - 460 kW		(130) 390 - 610 kW	
Gas pressure	20 - 300 mbar		20 - 300 mbar	
Control box / flame detection	TCG5... / ionization		TCG5... / ionization	
Fan motor	230 V - 50 Hz - 420 W		230 V - 50 Hz - 750 W	
Electrical consumption	68 + 522 W		68 + 720 W	
Acoustic level (LpA)	70 dB(A)		71 dB(A)	
CE certificate	1312 CL 5412		1312 CL 5412	
Head length	KN	KL	KN	KL
Complete burner code	MB-VEF 420 d1"1/2-Rp2"	3833887	3833875	3833876
	MB-VEF 412 d1"1/4-Rp1"1/4	3833891	3833879	3833880
	MB-VEF 407 d3/4"-Rp1"	3833895	3833883	3833884

OTHER AVAILABLE VERSIONS

- TC** Version with tightness control
- Vent** Versions for continuous ventilation and post-ventilation

SCOPE OF SUPPLY

- The burner is delivered in its package complete with:
- 1 burner head with flange seal and securing screws
 - 1 compact gas train with gas filter
 - 1 bag containing installation fittings
 - 1 bag containing technical documentation (instruction manual, technical data, electrical diagram, exploded view and spare parts list)



DIMENSIONS (mm)

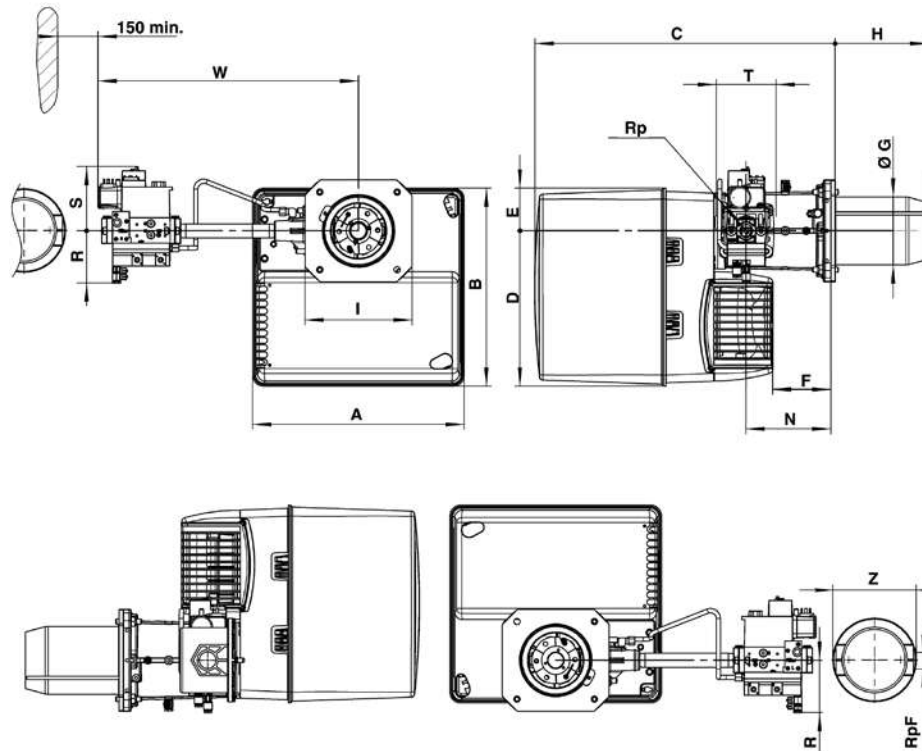

Gas train model	A	B	C	D	E	F	ØG	H		I	N	Rp	R	S	T	W	RpF	Z
								KN	KL									
d1"1/2-Rp2"	465	475	640	377	97	149	150	220	360	245	195	2"	100	185	100	613	-	-
d1"1/4-Rp1"1/4	465	475	640	377	97	149	150	220	360	245	195	1"1/4	80	175	145	536	-	-
d3/4"-Rp1"	465	475	640	377	97	149	150	220	360	245	195	1"	70	160	120	489	1"	160

Connecting flange

Øa (mm)	b (mm)	c	d
180-240	200-270	M10	45°

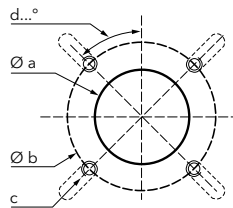

PACKAGING

The burner is delivered on a pallet in three packages containing:

- burner housing
- combustion head
- gas train and filter

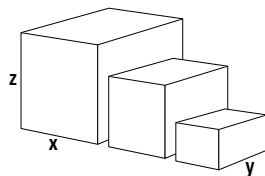

Component		Dimensions (mm)			Gross weight (kg)
		X	Y	Z	
Burner body	VG 4.460 V	490	490	590	28,6
	VG 4.610 V	490	490	590	32,7
Combustion head	KN	750	260	295	8,9
	KL	895	260	295	10,1
Gas train	d1"1/2-Rp2"	670	550	380	12
	d1"1/4-Rp1"1/4	600	400	240	11
	d3/4"-Rp1"	600	400	240	7

VG4.460 V / VG4.610 V

100 ... 610 kW

Two stage progressive/modulating pneumatic + fan speed control

PRESSURE LOSS [BURNER HEAD + GAS TRAIN] (mbar)

VG 4.460 V

Burner output (kW)	Natural gas G20 Hi = 10,35 kWh/m ³		Natural gas G25 Hi = 8,83 kWh/m ³			LPG G31 Hi = 25,89 kWh/m ³	
	d3/4"-Rp1"	d1"1/4-Rp1"1/4	d3/4"-Rp1"	d1"1/4-Rp1"1/4	d1"1/2-Rp2"	d3/4"-Rp1"	d1"1/4-Rp1"1/4
300	40	8	59	11	6	18	8
350	54	10	81	15	9	24	11
400	70	14	106	19	12	31	14
450	89	17	134	24	15	40	18
510	114	22	172	31	19	51	23

Natural gas G20

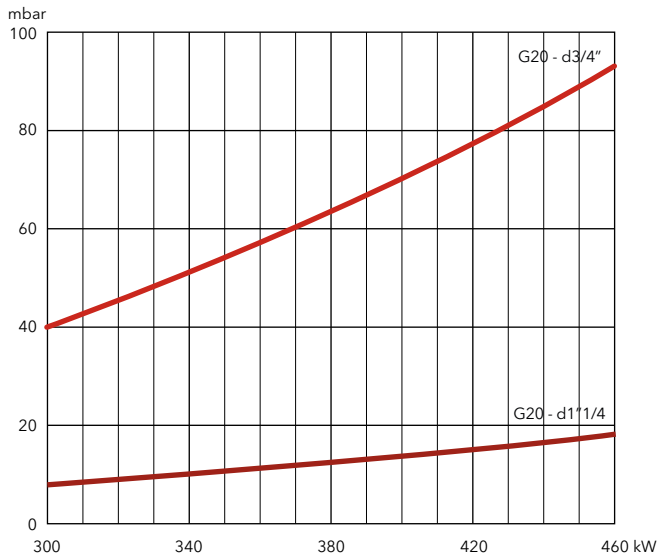

Natural gas G25

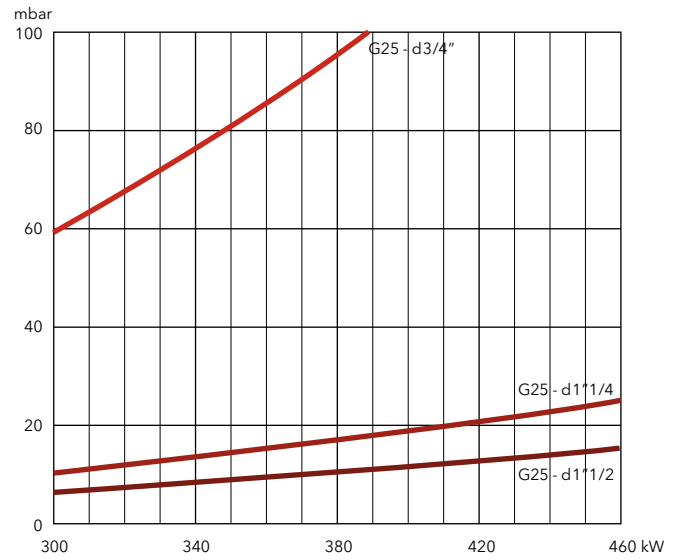

LPG

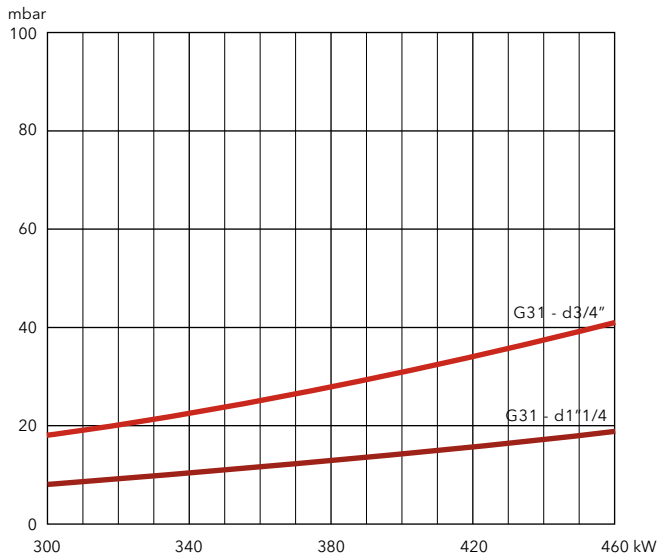



PRESSURE LOSS [BURNER HEAD + GAS TRAIN] (mbar)

VG 4.610 V

Burner output (kW)	Natural gas G20 Hi = 10,35 kWh/m ³			Natural gas G25 Hi = 8,83 kWh/m ³			LPG G31 Hi = 25,89 kWh/m ³	
	d3/4"-Rp1"	d1"1/4-Rp1"1/4	d1"1/2-Rp2"	d3/4"-Rp1"	d1"1/4-Rp1"1/4	d1"1/2-Rp2"	d3/4"-Rp1"	d1"1/4-Rp1"1/4
350	53	9	6	78	13	7	25	8
400	70	12	8	102	17	9	32	10
450	88	16	10	129	21	11	41	13
500	109	19	12	159	26	14	50	16
550	132	23	15	192	32	17	61	20
610	162	29	18	236	39	20	75	24

Natural gas G20

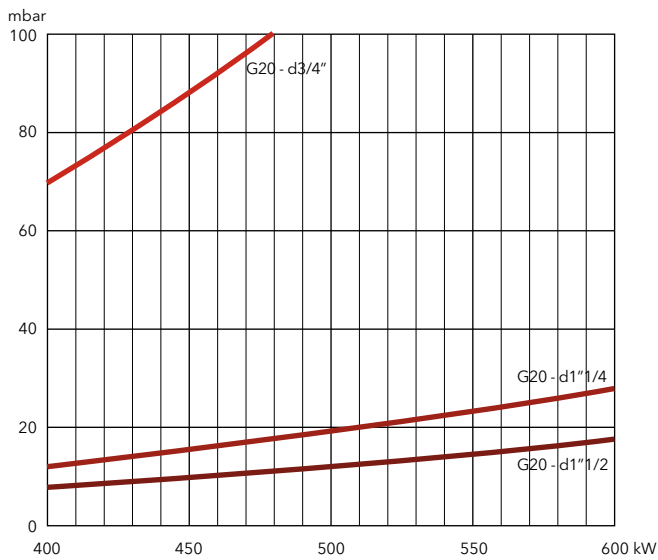

Natural gas G25

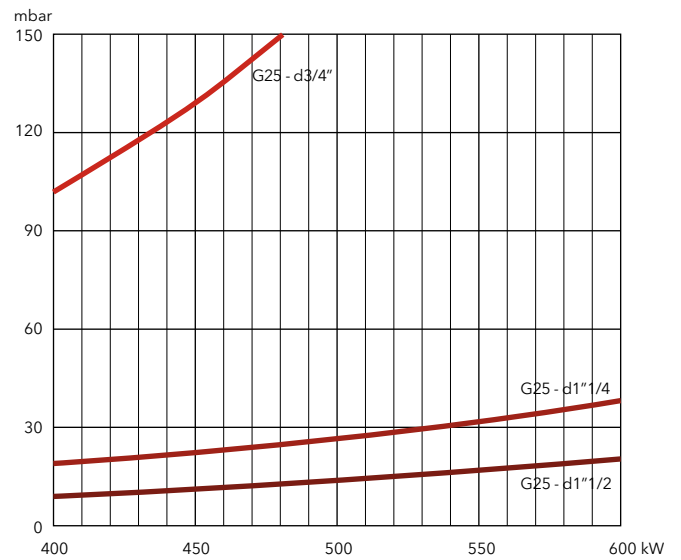

LPG

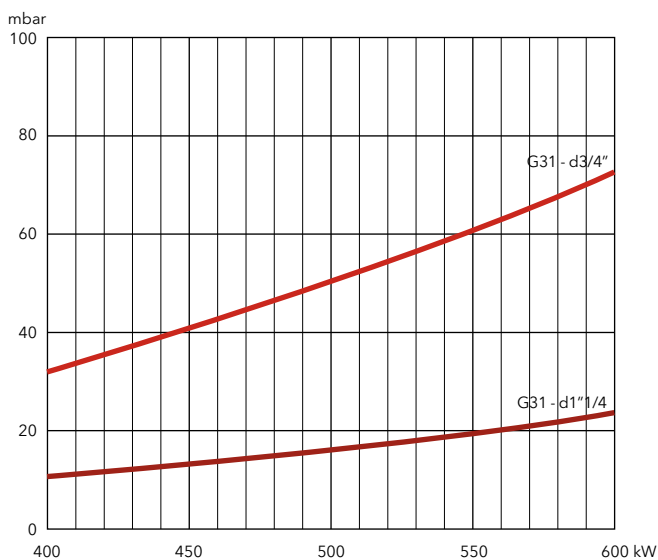

VG2.90 M E / VG2.120 M E / VG2.160 M E / VG2.205 M E

20 ... 205 kW

Two stage progressive/modulating electronic



- **Fuels:** natural gas (G20/G25, $H_u = 8,83...10,35 \text{ kWh/m}^3$); LPG (G31, $H_u = 25,89 \text{ kWh/m}^3$)
- **Emissions:** $\text{NO}_x < 56 \text{ mg/kWh}$ (GCV), burners compliant with ErP Directive
- **Operation:** two stage progressive or modulating with the installation of a power regulator and dedicated probes (see page 218)
- **Protection level:** IP 21

TECHNICAL DATA

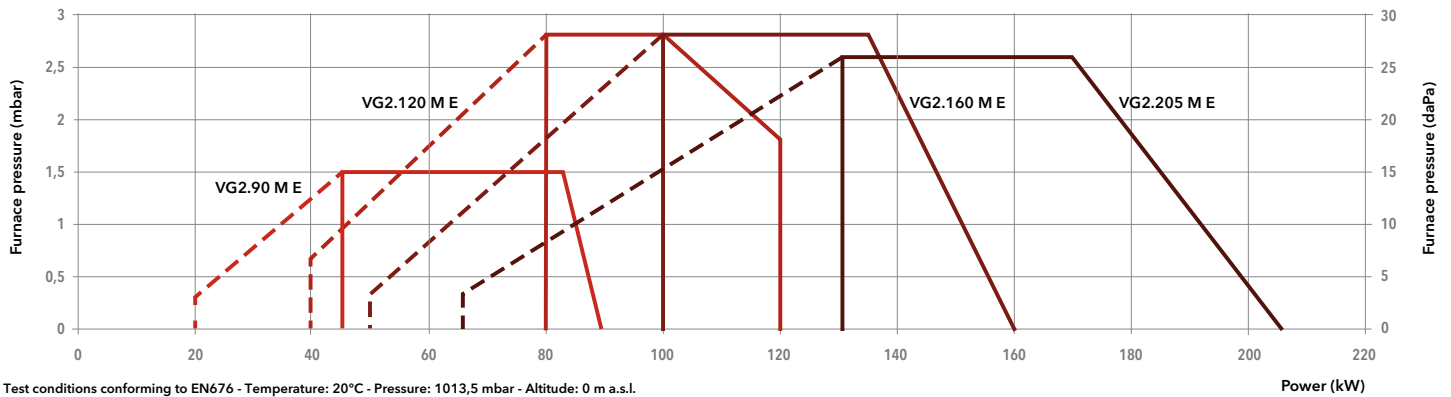

Model	VG2.90 M E		VG2.120 M E /TC		VG2.160 M E /TC		VG2.205 M E /TC		
Operation range	(20) 45 - 90 kW		(40) 80 - 120 kW		(50) 100 - 160 kW		(65) 130 - 205 kW		
Gas pressure	20 - 360 mbar		20 - 360 mbar		20 - 360 mbar		20 - 360 mbar		
Control box / flame detection	BT3... / ionization		BT3... / ionization		BT3... / ionization		BT3... / ionization		
Fan motor	230 V - 50 Hz - 75 W		230 V - 50 Hz - 100 W		230 V - 50 Hz - 100 W		230 V - 50 Hz - 130 W		
Electrical consumption (min/max/stand-by)	140 W / 145 W / 4 W		239 W / 358 W / 4 W		285 W / 293 W / 4 W		302 W / 267 W / 4 W		
Acoustic level (LpA)	64 dB(A)		64 dB(A)		64 dB(A)		64 dB(A)		
CE certificate	0476 DN 1270		0476 CT 2423		0476 CT 2423		0476 CT 2423		
Head length	KN	KL	KN	KL	KN	KL	KN	KL	
Complete burner code	MBC300 d3/4"-Rp3/4"/TC MB-DLE 405 d3/4"-Rp3/4"	3837236 3837238	3837237 3837239	3836480 -	3836481 -	3836482 -	3836483 -	3836484 -	3836485 -

OTHER AVAILABLE VERSIONS

Versions for continuous ventilation and post-ventilation

SCOPE OF SUPPLY

The burner is delivered in its package complete with:

- 1 gas connection flange
- 1 compact gas train with gas filter; the gas filter is built-in for threaded valves (up to 2") and separated for flanged ones (DN65/80/100)
- 1 burner flange with insulation
- 1 bag containing installation fittings
- 1 bag containing technical documentation (instruction manual, technical data, electrical diagram, exploded view and spare parts list)



DIMENSIONS (mm)

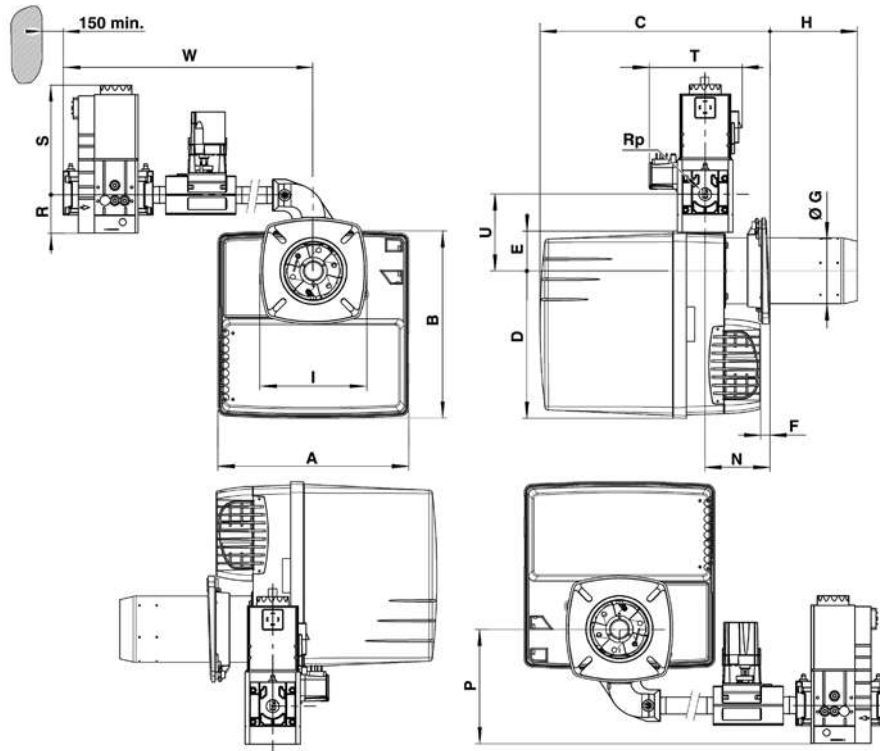

Model	A	B	C		D	E	F min	ØG	H		I	N min	P	Rp	R	S	T	U	W
			KN	KL					KN	KL									
VG2.90	331	325	398...480	398...600	256	69	15	100	70...150	70...270	185	105	179	3/4"	70	160	120	133	345
VG2.120/160	331	325	398...518	398...638	256	69	15	115	30...150	30...270	185	113	193	3/4"	60	173	146	133	455
VG2.205	331	325	398...518	398...638	256	69	15	125	30...150	30...270	185	113	193	3/4"	60	173	146	133	455

Connecting flange

Model	Øa (mm)	b (mm)	c	d
VG2.90...160	120-135	150-185	M8	45°
VG2.205	130-145	160-185	M8	45°

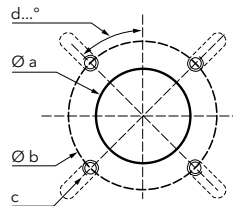

PACKAGING

The burner is delivered in two packages containing:

- burner housing and combustion head;
- gas train and filter.

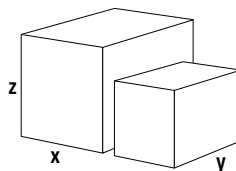

Component	Dimensions (mm)			Gross weight (kg)	
	X	Y	Z		
Burner body	VG2.90 M E	400	440	520	25
	VG2.120 M E	400	440	520	25
	VG2.160 M E	400	440	520	25
	VG2.205 M E	400	440	520	25
Gas train	d3/4"-Rp3/4"	540	670	380	12

VG2.90 M E / VG2.120 M E / VG2.160 M E / VG2.205 M E

20 ... 205 kW
Two stage progressive/modulating electronic

PRESSURE LOSS [BURNER HEAD + GAS TRAIN] (mbar)

VG2.90 M E

Burner output (kW)	Natural gas G20 Hi = 10,35 kWh/m ³	Natural gas G25 Hi = 8,83 kWh/m ³
	d3/4"-Rp3/4"	d3/4"-Rp3/4"
30	3,5	4
50	6,5	8,2
70	10,2	13,7
90	14,4	20,5

Natural gas G20

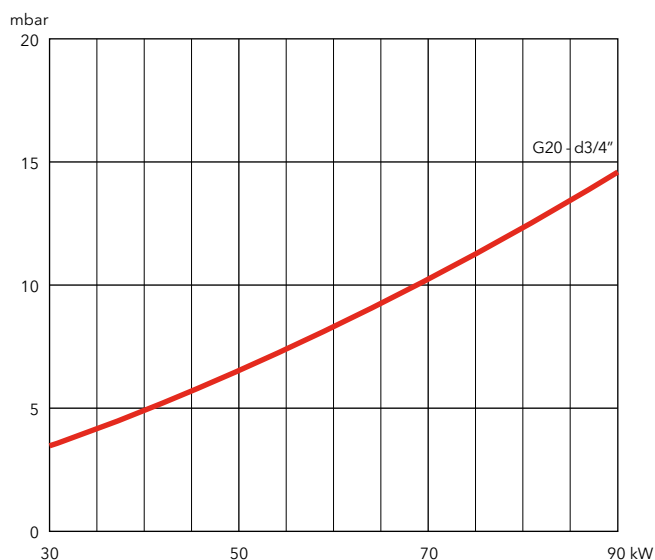

Natural gas G25

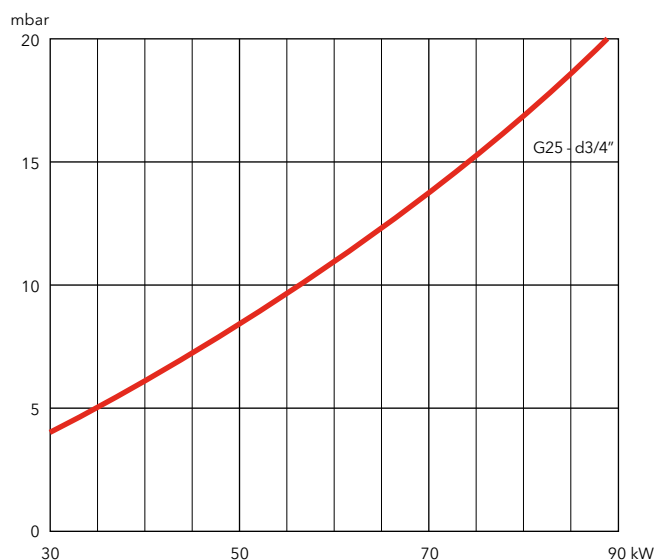



PRESSURE LOSS [BURNER HEAD + GAS TRAIN] (mbar)

VG2.90 M E

Burner output (kW)	LPG G31 Hi = 25,89 kWh/m ³
	d3/4"·Rp3/4"
30	3,3
50	5,7
70	8,3
90	11,2

LPG

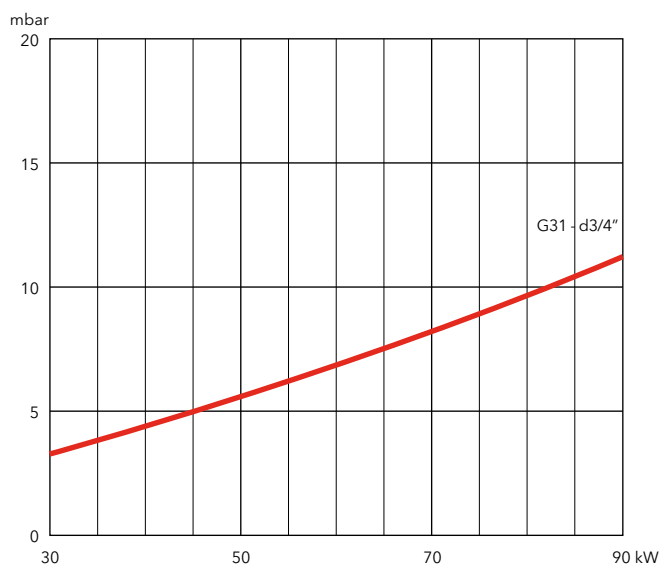

VG3.290 M E / VG3.350 M E

95 ... 350 kW

Two stage progressive/modulating electronic

- **Fuels:** natural gas (G20/G25, $H_u = 8,83 \dots 10,35 \text{ kWh/m}^3$); LPG (G31, $H_u = 25,89 \text{ kWh/m}^3$)
- **Emissions:** $\text{NO}_x < 56 \text{ mg/kWh}$ (GCV), burners compliant with ErP Directive
- **Operation:** two stage progressive or modulating with the installation of a power regulator and dedicated probes (see page 218), and integrated tightness control
- **Protection level:** IP 21



TECHNICAL DATA

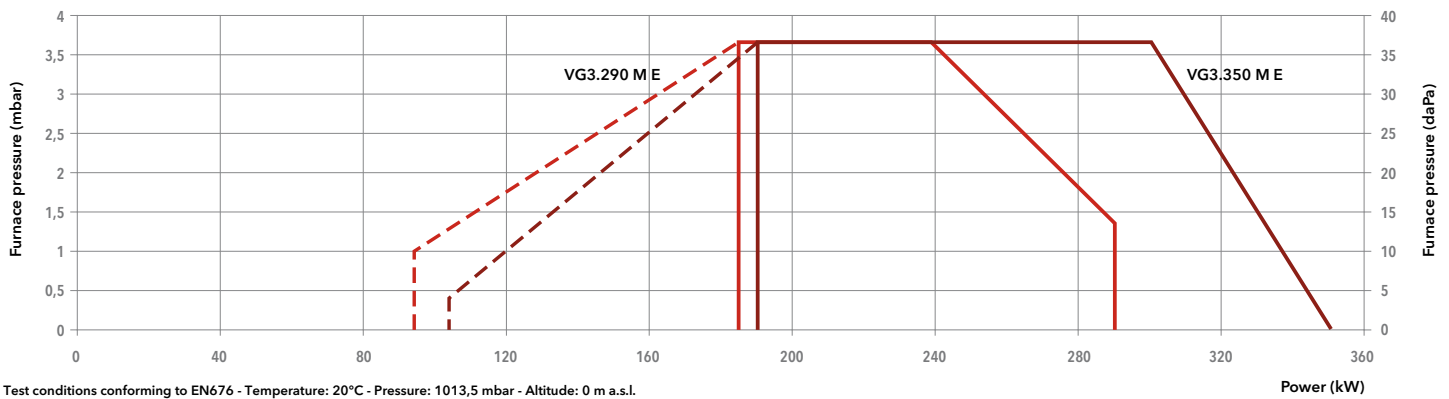

Model	VG3.290 M E /TC		VG3.350 M E /TC	
Operation range	(95) 185 - 290 kW		(105) 190 - 350 kW	
Gas pressure	20 - 360 mbar		20 - 360 mbar	
Control box / flame detection	BT3... / ionization		BT3... / ionization	
Fan motor	230 V - 50 Hz - 250 W		230 V - 50 Hz - 300 W	
Electrical consumption (max/min/stand-by)	465 W / 441 W / 4 W		583 W / 583 W / 4 W	
Acoustic level (LpA)	67 dB(A)		69 dB(A)	
CE certificate	0476 CT 2423		0476 CT 2423	
Head length	KN	KL	KN	KL
Complete burner code	MBC700 d1"1/2-Rp1"1/2/TC MBC300 d3/4"-Rp1"1/4/TC	- 3836486	- 3836487	3836488 3836490
				3836489 3836491

OTHER AVAILABLE VERSIONS

Versions for continuous ventilation and post-ventilation

SCOPE OF SUPPLY

The burner is delivered in its package complete with:

- 1 burner head with flange seal and securing screws
- 1 compact gas train with gas filter; the gas filter is built-in for threaded valves (up to 2") and separated for flanged ones (DN65/80/100)
- 1 bag containing installation fittings
- 1 bag containing technical documentation (instruction manual, technical data, electrical diagram, exploded view and spare parts list)



DIMENSIONS (mm)

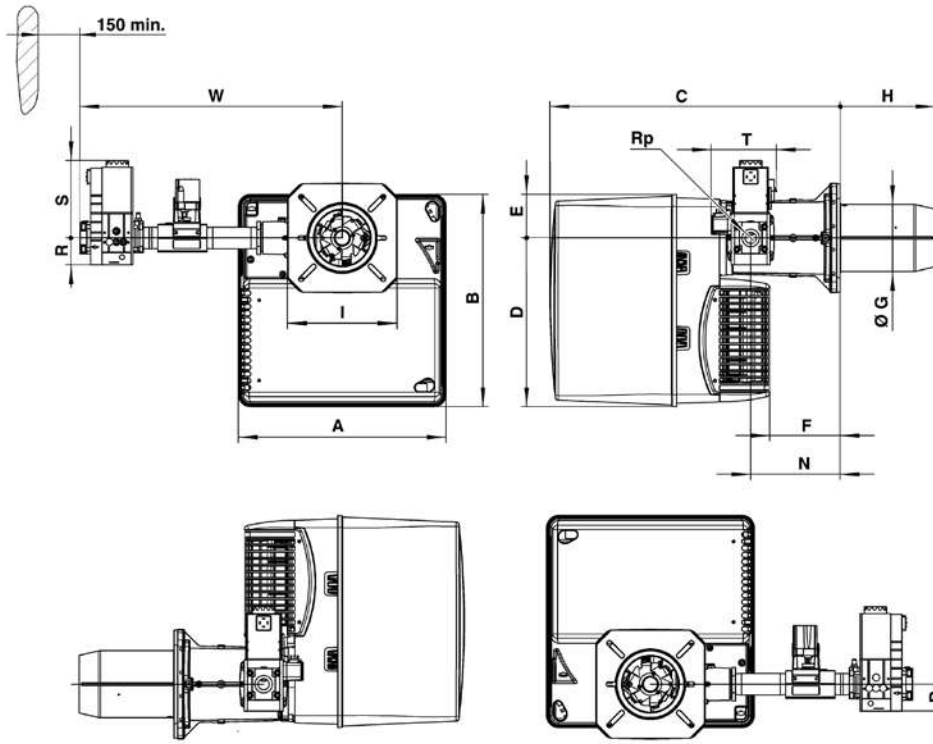

Gas train model	A	B	C	D	E	F	ØG	H		I	N	Rp	R	S	T	W
								KN	KL							
d1"1/2-Rp1"1/2/TC	406	379	576	297	82	120	130	180	320	195x205	170	1"1/2	80	185	160	638
d3/4"-Rp1"1/4/TC	406	379	576	297	82	120	130	180	320	195x205	170	1"1/4	60	173	146	577

Connecting flange

Øa (mm)	b (mm)	c	d
155-190	175-220	M10	45°

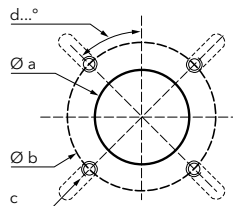

PACKAGING

The burner is delivered on a pallet in three packages containing:

- burner housing
- combustion head
- gas train and filter

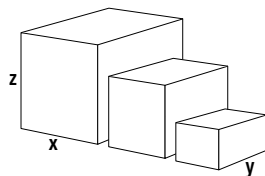

Component		Dimensions (mm)			Gross weight (kg)
		X	Y	Z	
Burner body	VG3.290 M E	440	400	520	21
	VG3.350 M E	440	400	520	22
Combustion head	KN	650	210	260	6
	KL	780	210	260	7
Gas train	d1"1/2-Rp1"1/2/TC	670	540	380	12
	d3/4"-Rp1"1/4/TC	670	540	380	12

VG3.290 M E / VG3.350 M E

95 ... 350 kW

Two stage progressive/modulating electronic

PRESSURE LOSS [BURNER HEAD + GAS TRAIN] (mbar)

VG3.290 M E

Burner output (kW)	Natural gas G20 Hi = 10,35 kWh/m ³	Natural gas G25 Hi = 8,83 kWh/m ³	LPG G31 Hi = 25,89 kWh/m ³
	d3/4"-Rp1"1/4	d3/4"-Rp1"1/4	d3/4"-Rp1"1/4
190	12	14	10
210	12	15	10
230	13	16	10
250	14	18	10
270	16	20	11
290	18	23	12

Natural gas G20

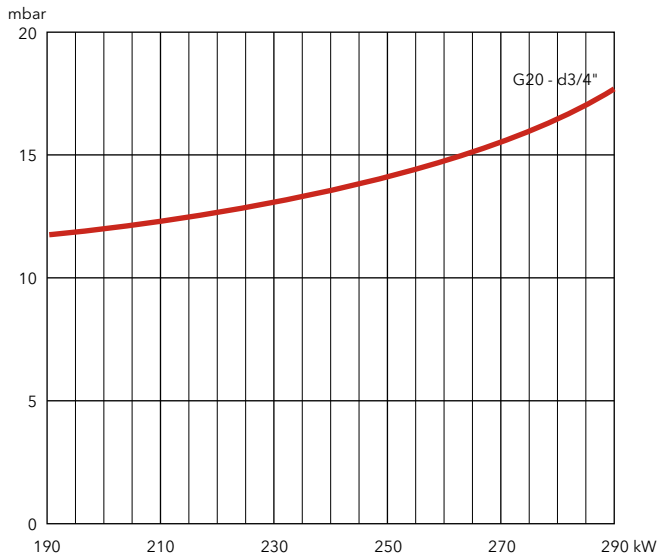

Natural gas G25

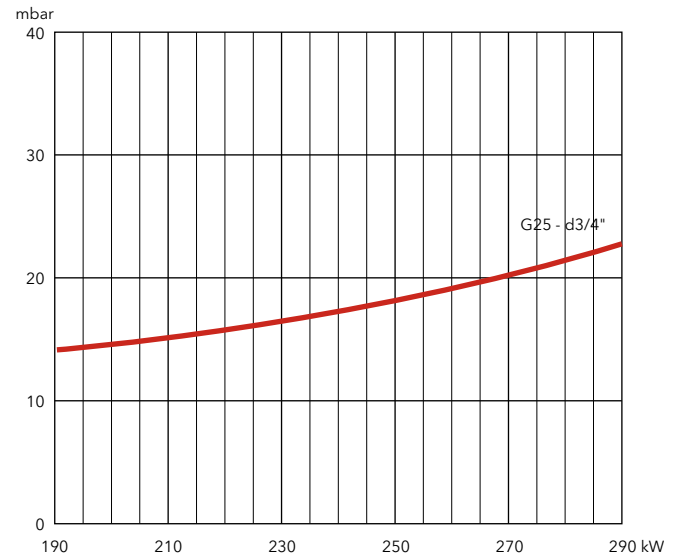

LPG

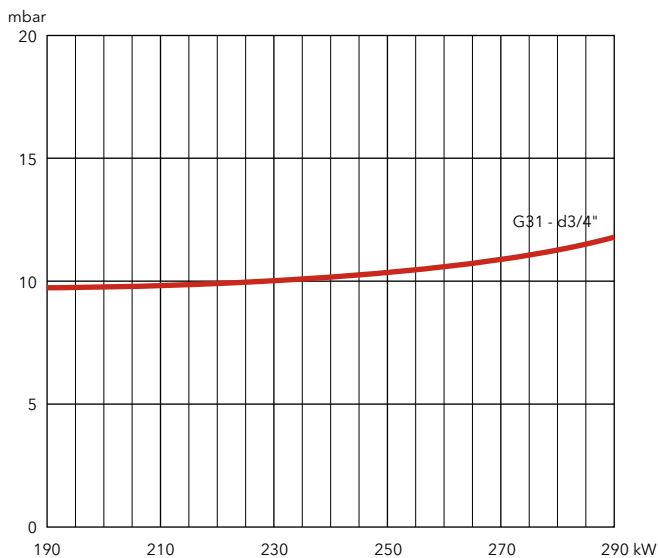



PRESSURE LOSS [BURNER HEAD + GAS TRAIN] (mbar)

VG3.350 M E

Burner output (kW)	Natural gas G20 Hi = 10,35 kWh/m ³		Natural gas G25 Hi = 8,83 kWh/m ³		LPG G31 Hi = 25,89 kWh/m ³	
	d3/4"-Rp1"1/4	d1"1/2-Rp1"1/2	d3/4"-Rp1"1/4	d1"1/2-Rp1"1/2	d3/4"-Rp1"1/4	d1"1/2-Rp1"1/2
190	9	5	11	5	7	6
230	10	6	15	6	8	7
270	12	7	19	7	11	8
310	15	9	25	9	13	10
350	20	11	32	12	16	12

Natural gas G20

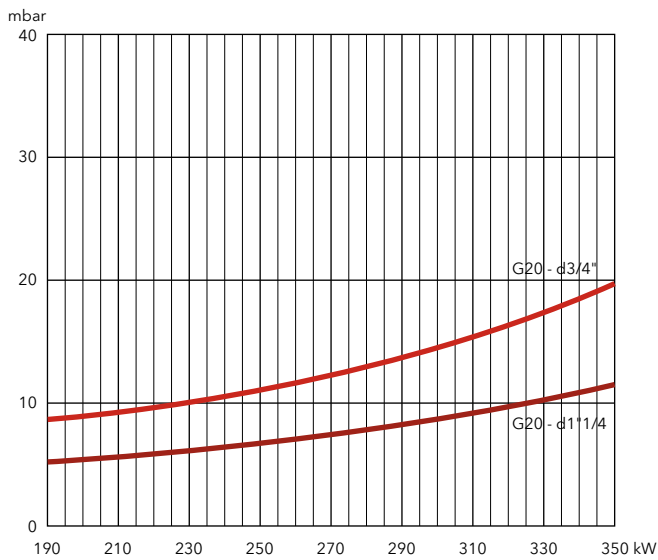

Natural gas G25

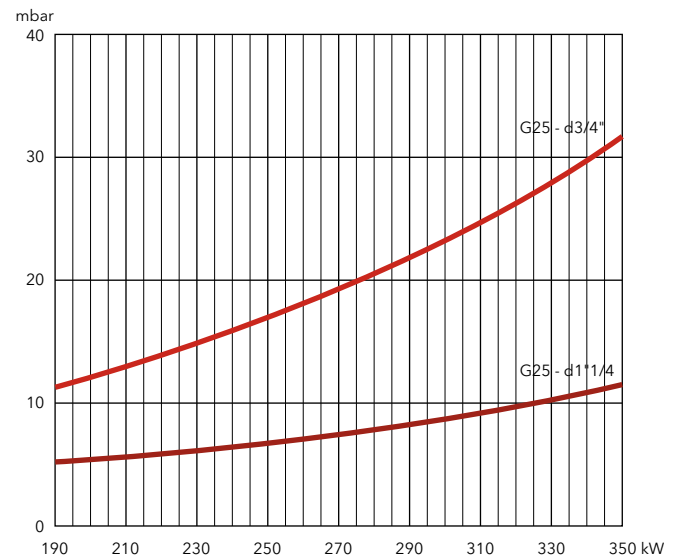

LPG

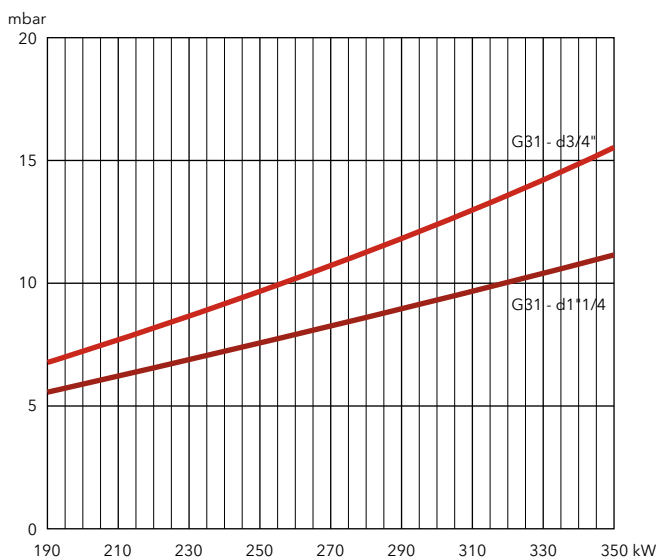

VG4.440 M E

110 ... 440 kW

Two stage progressive/modulating electronic

- **Fuels:** natural gas (G20/G25, $H_u = 8,83...10,35 \text{ kWh/m}^3$); LPG (G31, $H_u = 25,89 \text{ kWh/m}^3$)
- **Emissions:** $\text{NO}_x < 56 \text{ mg/kWh}$ (GCV), burners compliant with ErP Directive
- **Operation:** two stage progressive or modulating with the installation of a power regulator and dedicated probes (see page 218), and integrated tightness control
- **Protection level:** IP 21



TECHNICAL DATA

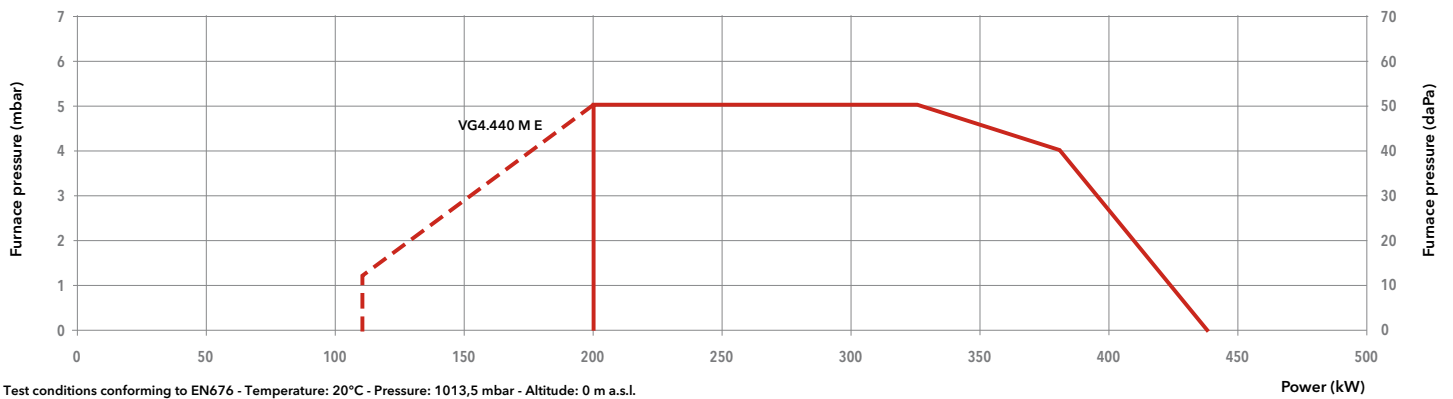

Model	VG4.440 M E /TC		
Operation range	(110) 200 - 440		
Gas pressure	20 - 360 mbar		
Control box / flame detection	BT3... / ionization		
Fan motor	230 V - 50 Hz - 420 W		
Electrical consumption (max/min/stand-by)	606 W / 569 W / 4 W		
Acoustic level (LpA)	70 dB(A)		
CE certificate	0476 CT 2423		
Head length	KN		KL
Complete burner code	MBC700 d1"1/2-Rp1"1/2/TC	3836492	3836493
	MBC300 d3/4"-Rp1"1/4/TC	3836494	3836495

OTHER AVAILABLE VERSIONS

Versions for continuous ventilation and post-ventilation

SCOPE OF SUPPLY

The burner is delivered in its package complete with:

- 1 burner head with flange seal and securing screws
- 1 compact gas train with gas filter; the gas filter is built-in for threaded valves (up to 2") and separated for flanged ones (DN65/80/100)
- 1 bag containing installation fittings
- 1 bag containing technical documentation (instruction manual, technical data, electrical diagram, exploded view and spare parts list)



DIMENSIONS (mm)

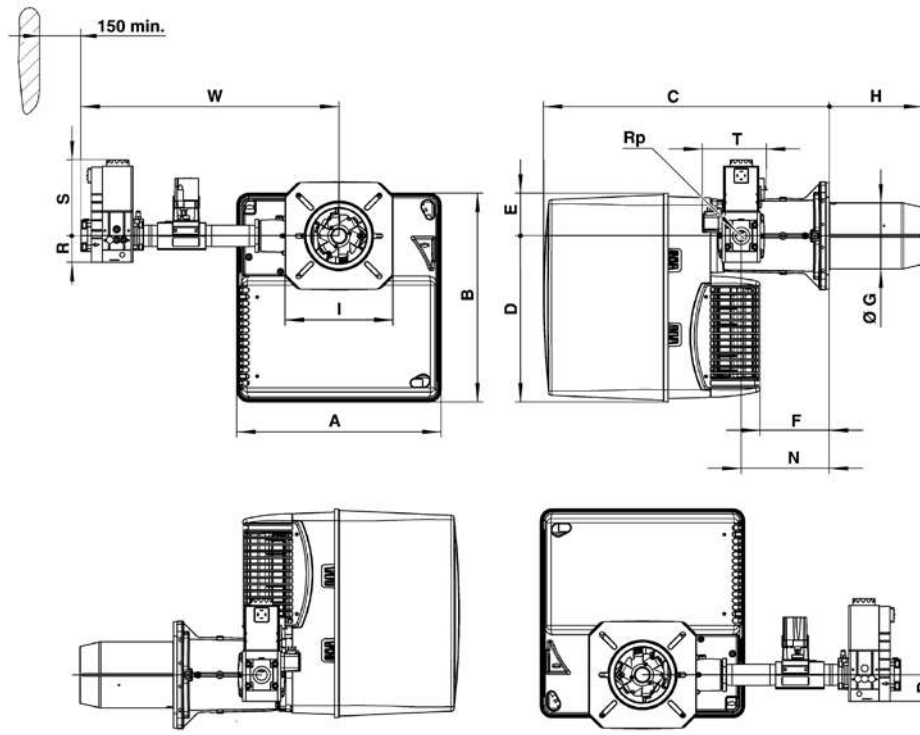

Gas train model	A	B	C	D	E	F	ØG	H		I	N	Rp	R	S	T	W
								KN	KL							
d1"1/2-Rp1"1/2/TC	465	475	640	377	97	149	157	212	352	245	195	1"1/2	80	185	160	649
d3/4"-Rp1"1/4/TC	465	475	640	377	97	149	157	212	352	245	195	1"1/4	60	173	146	587

Connecting flange

Øa (mm)	b (mm)	c	d
190-240	200-270	M10	45°

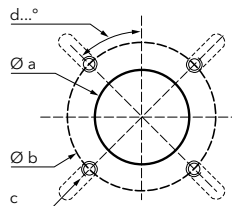

PACKAGING

The burner is delivered on a pallet in three packages containing:

- burner housing
- combustion head
- gas train and filter

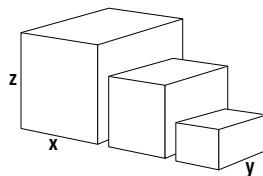

Component	Component	Dimensions (mm)			Gross weight (kg)
		X	Y	Z	
Burner body	VG4.440 M E	490	490	590	28,6
Combustion head	KN	750	260	295	8,9
	KL	895	260	295	10,1
Gas train	d1"1/2-Rp1"1/2/TC	670	540	380	12
	d3/4"-Rp1"1/4/TC	670	540	380	12

VG4.440 M E

110 ... 440 kW

Two stage progressive/modulating electronic

PRESSURE LOSS [BURNER HEAD + GAS TRAIN] (mbar)

VG4.440 M E

Burner output (kW)	Natural gas G20 Hi = 10,35 kWh/m ³		Natural gas G25 Hi = 8,83 kWh/m ³	
	d3/4"-Rp1"1/4	d1"1/2-Rp1"1/2	d3/4"-Rp1"1/4	d1"1/2-Rp1"1/2
240	11	7	15	9
280	13	8	18	10
320	16	9	22	12
360	19	10	28	14
400	23	12	34	17
440	28	14	41	20

Natural gas G20

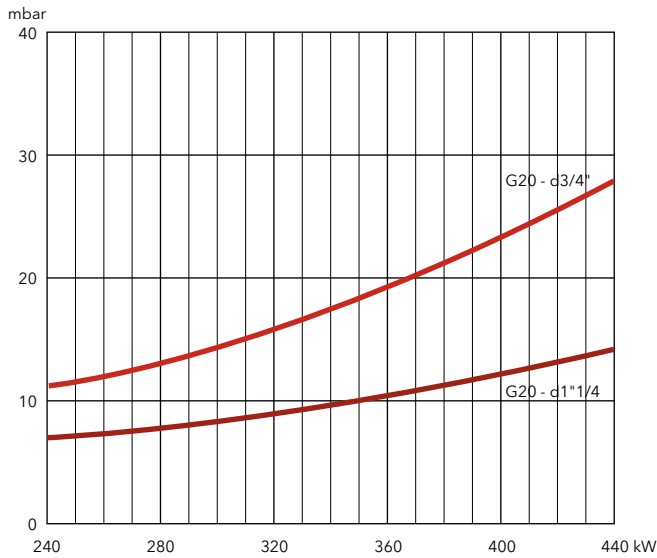

Natural gas G25

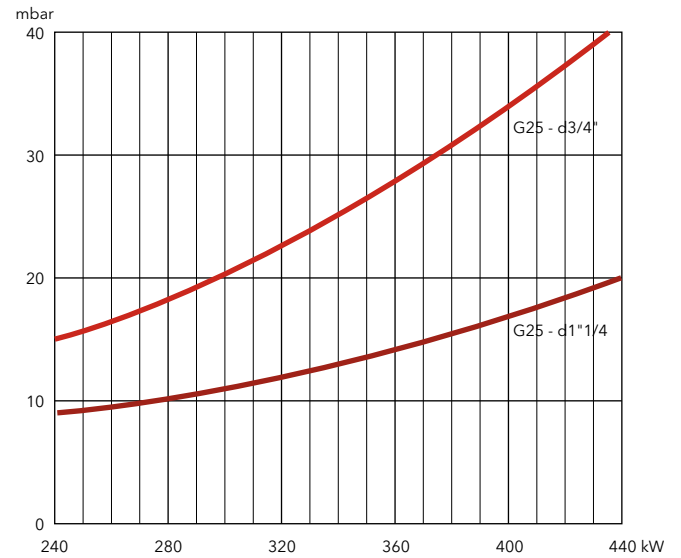



PRESSURE LOSS [BURNER HEAD + GAS TRAIN] (mbar)

VG4.440 M E

Burner output (kW)	LPG G31 Hi = 25,89 kWh/m ³	
	d3/4"-Rp1"1/4	d1"1/2-Rp1"1/2
240	10	8
280	11	9
320	13	9
360	15	11
400	17	13
440	20	15

LPG

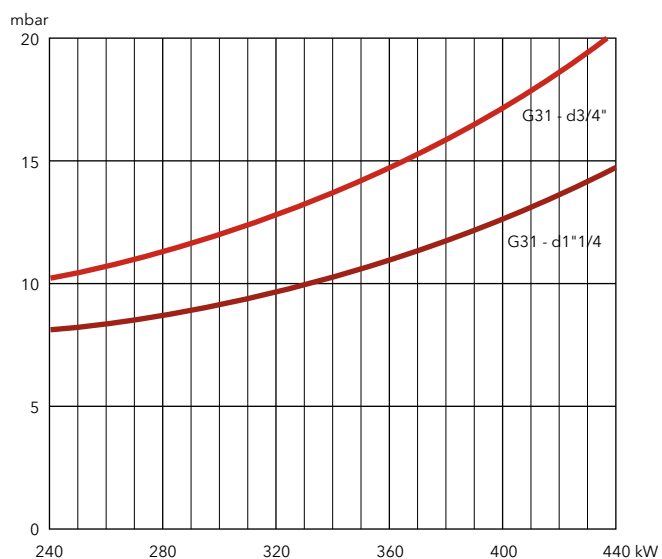

VG4.460 M / VG4.610 M

86 ... 610 kW

Two stage progressive/modulating electronic

- **Fuels:** natural gas, net calorific value 8,83...10,35 kWh/m³;
LPG, net calorific value 25,89 kWh/m³
- **Emissions:** NOx < 70 mg/kWh (NCV), Low NOx class 3 burners according to EN676
- **Operation:** two stage progressive or modulating with the installation of a power regulator and dedicated probes (see page 218), and integrated tightness control
- **Protection level:** IP 41



TECHNICAL DATA

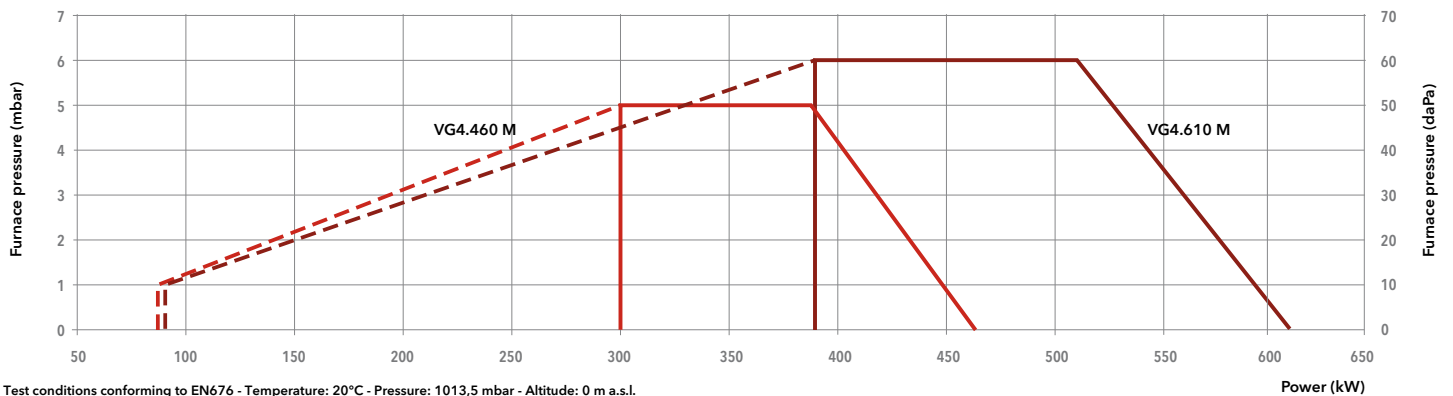

Model	VG 4.460 M /TC		VG 4.610 M /TC	
Operation range	(86) 300 - 460		(90) 390 - 610 kW	
Gas pressure	20 - 300 mbar		20 - 300 mbar	
Control box / flame detection	BT3... / ionization		BT3... / ionization	
Fan motor	230 V - 50 Hz - 420 W		230 V - 50 Hz - 750 W	
Electrical consumption	510 W		760 W	
Acoustic level (LpA)	70 dB(A)		71 dB(A)	
CE certificate	0085 CN 0192		0085 CN 0192	
Head length	KN	KL	KN	KL
Complete burner code	MBC700 d1"1/2-Rp1"1/2/TC MBC300 d3/4"-Rp1"1/4/TC	3833782 3833780	3833783 3833781	3833786 3833784
				3833787 3833785

OTHER AVAILABLE VERSIONS

Versions for continuous ventilation and post-ventilation

SCOPE OF SUPPLY

The burner is delivered in its package complete with:

- 1 burner head with flange seal and securing screws
- 1 compact gas train with gas filter
- 1 bag containing installation fittings
- 1 bag containing technical documentation (instruction manual, technical data, electrical diagram, exploded view and spare parts list)



DIMENSIONS (mm)

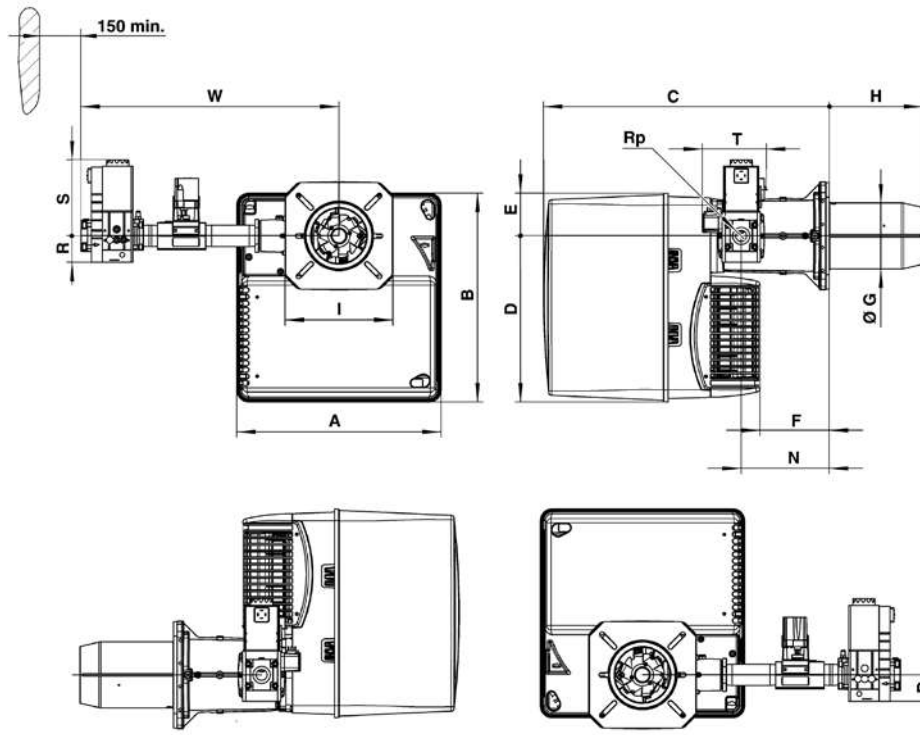

Gas train model	A	B	C	D	E	F	ØG	H		I	N	Rp	R	S	T	W
								KN	KL							
d1"1/2-Rp1"1/2/TC	465	475	640	377	97	149	150	220	360	245	195	1"1/2	80	185	160	649
d3/4"-Rp1"1/4/TC	465	475	640	377	97	149	150	220	360	245	195	1"1/4	60	173	146	587

Connecting flange

Øa (mm)	b (mm)	c	d
180-240	200-270	M10	45°

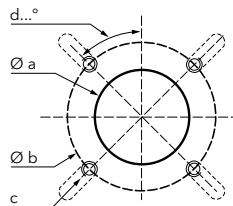

PACKAGING

The burner is delivered on a pallet in three packages containing:

- burner housing
- combustion head
- gas train and filter

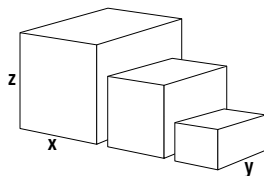

Component		Dimensions (mm)			Gross weight (kg)
		X	Y	Z	
Burner body	VG 4.460 M	490	490	590	28,6
	VG 4.610 M	490	490	590	32,7
Combustion head	KN	750	260	295	8,9
	KL	895	260	295	10,1
Gas train	d1"1/2-Rp1"1/2/TC	670	540	380	12
	d3/4"-Rp1"1/4/TC	670	540	380	12

VG4.460 M / VG4.610 M

86 ... 610 kW

Two stage progressive/modulating electronic

PRESSURE LOSS [BURNER HEAD + GAS TRAIN] (mbar)

VG 4.460 M

Burner output (kW)	Natural gas G20 Hi = 10,35 kWh/m ³		Natural gas G25 Hi = 8,83 kWh/m ³		LPG G31 Hi = 25,89 kWh/m ³
	d3/4"-Rp1"1/4	d1"1/2-Rp1"1/2	d3/4"-Rp1"1/4	d1"1/2-Rp1"1/2	d3/4"-Rp1"1/4
300	15	6	20	8	10
350	19	7	27	10	13
400	24	8	34	12	16
450	30	10	43	15	19

Natural gas G20

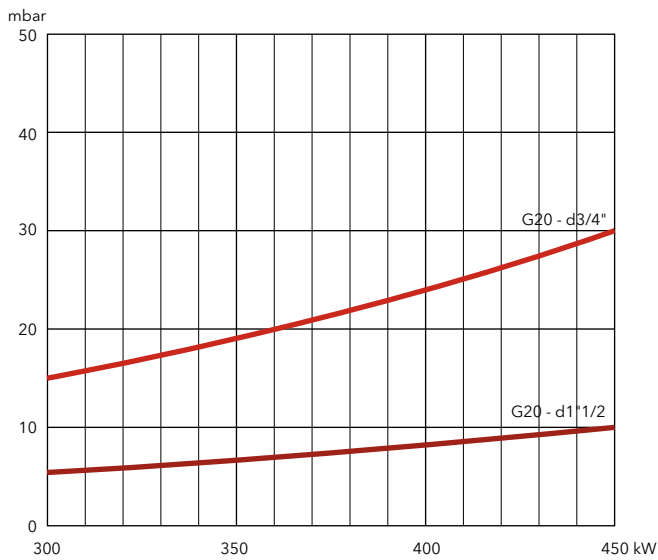

Natural gas G25

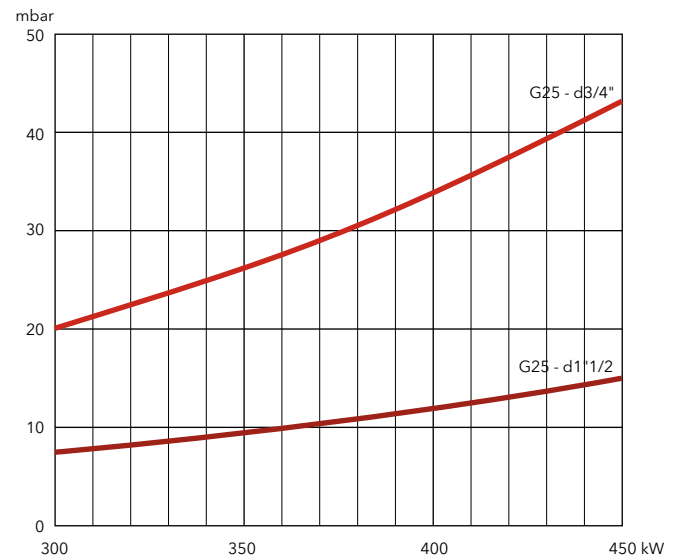

LPG

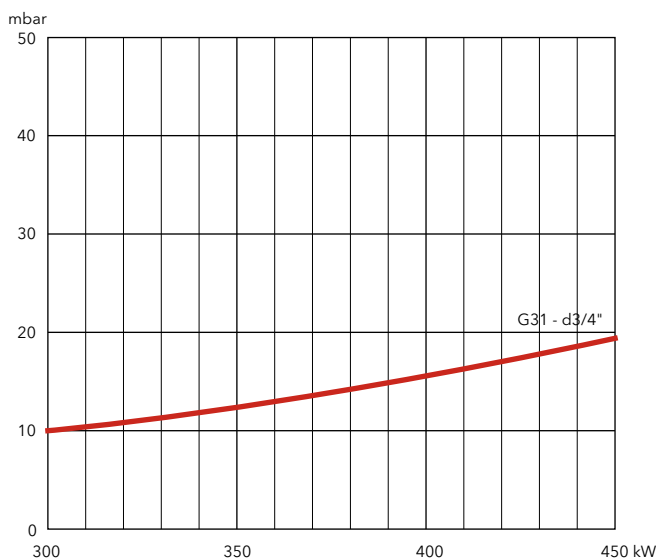



PRESSURE LOSS [BURNER HEAD + GAS TRAIN] (mbar)

VG 4.610 M

Burner output (kW)	Natural gas G20 Hi = 10,35 kWh/m ³		Natural gas G25 Hi = 8,83 kWh/m ³		LPG G31 Hi = 25,89 kWh/m ³
	d3/4"-Rp1"1/4	d1"1/2-Rp1"1/2	d3/4"-Rp1"1/4	d1"1/2-Rp1"1/2	d3/4"-Rp1"1/4
400	23	8	32	10	13
450	29	10	40	12	15
500	35	12	50	15	18
550	42	14	61	18	21
600	50	16	73	22	25

Natural gas G20

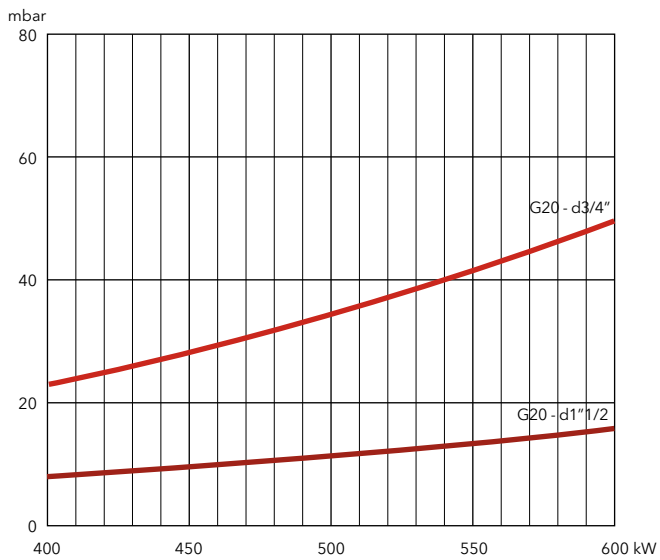

Natural gas G25

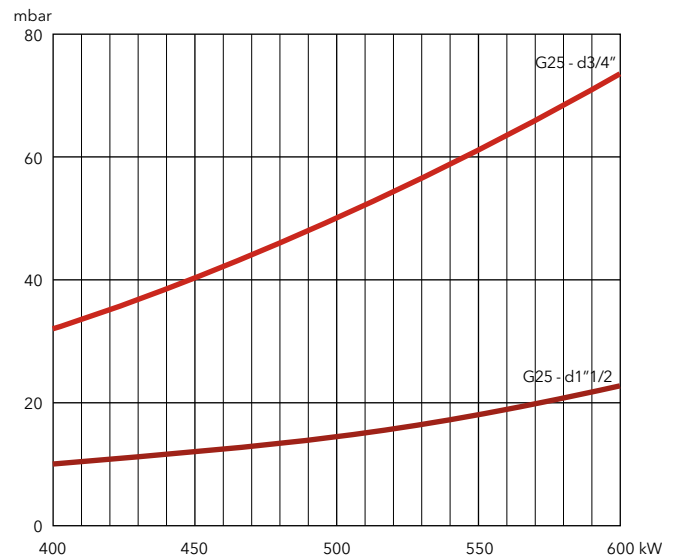

LPG

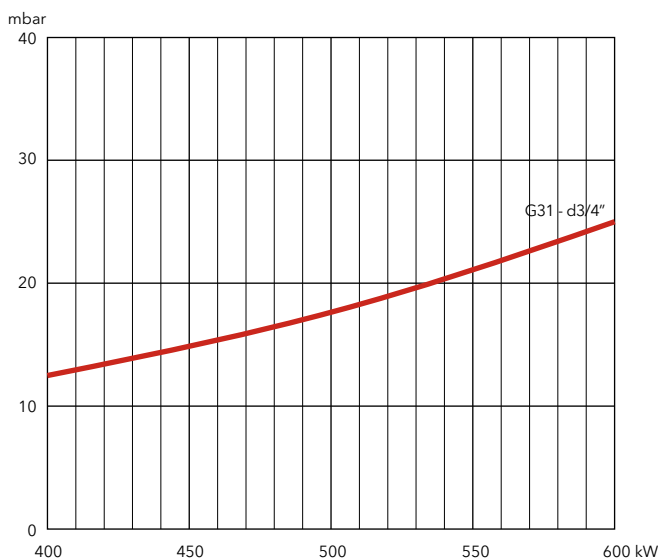

VG5.750 M

160 ... 800 kW

Two stage progressive/modulating electronic

- **Fuels:** natural gas (G20/G25, $H_u = 8,83...10,35 \text{ kWh/m}^3$);
LPG (G31, $H_u = 25,89 \text{ kWh/m}^3$)
- **Emissions:** $\text{NO}_x < 70 \text{ mg/kWh}$ (NCV), Low NO_x class 3 burners according to EN676
- **Operation:** two stage progressive or modulating with the installation of a power regulator and dedicated probes (see page 218), and integrated tightness control
- **Protection level:** IP 21

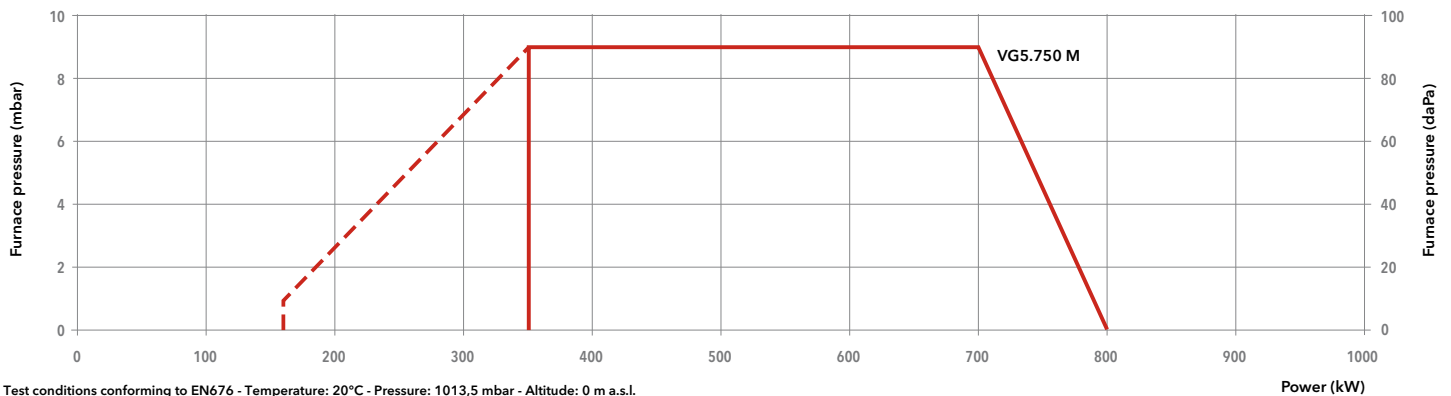
**TECHNICAL DATA**

Model		VG5.750 M /TC		
Operation range		(160) 350 – 800 kW		
Gas pressure		20 – 300 mbar		
Control box / flame detection		BT3... / ionization		
Fan motor		230/400 V – 50 Hz – 1,1 kW		
Electrical consumption		53 + 1700 W		
Acoustic level (LpA)		77 dB(A)		
CE certificate		0476 DN 1270		
Head length		KN	KL	KM
Complete burner code	VGD40-065 s65-DN65/TC	3837043	3837048	3837058
	MBC1900 d65-DN65/TC	3837044	3837049	3837059
	MBC1200 d2"-Rp2"/TC	3837045	3837050	3837060
	MBC700 d1"1/2-Rp2"/TC	3837046	3837051	3837061
	MBC300 d3/4"-Rp1"1/4/TC	3837047	3837052	3837062

OTHER AVAILABLE VERSIONS

Vent Versions for continuous ventilation and post-ventilation

PED PED version for continuous operation

SCOPE OF SUPPLY

The burner is delivered in its package complete with:

- 1 burner head with flange seal and securing screws
- 1 compact gas train with gas filter; the gas filter is built-in for threaded valves (up to 2") and separated for flanged ones (DN65/80/100)
- 1 bag containing installation fittings
- 1 bag containing technical documentation (instruction manual, technical data, electrical diagram, exploded view and spare parts list)



DIMENSIONS (mm)

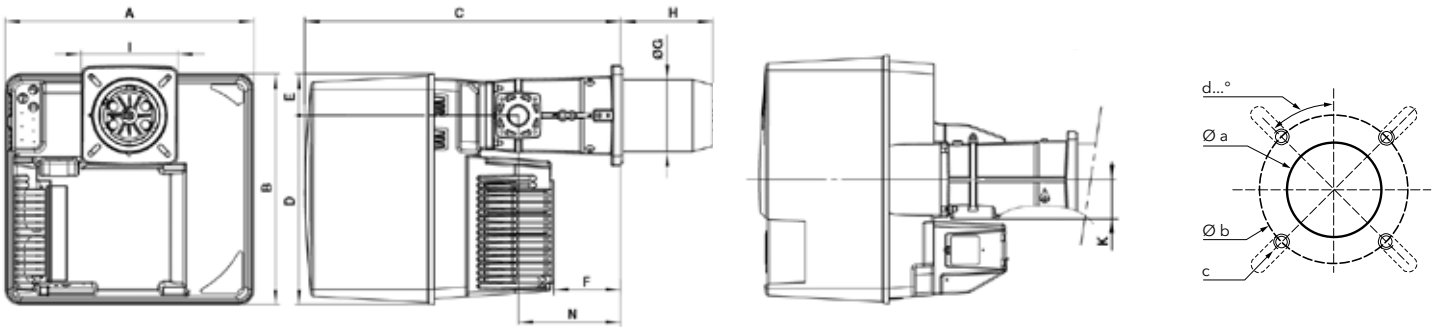

A	B	C	D	E	F	ØG	H			I	K	N
							KN	KM	KL			
581	549	752	450	99	164	170	285	395	505	230x238	89	244

Øa (mm)	b (mm)	c	d
195	220-260	M10	45°

Gas trains

Gas train "d":

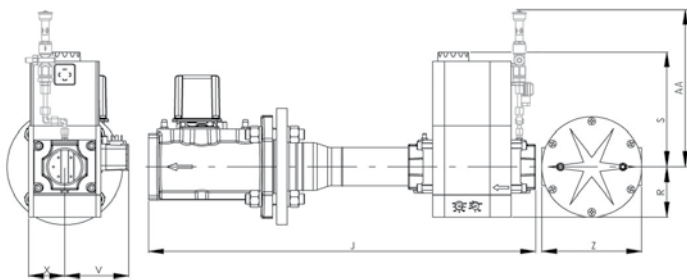

Model	J	R	S	V	X	Z	AA*
d65-DN65	490	183	245	110	98	290	385
d2"-Rp2"	700	96	330	125	81	-	385
d1"1/2-Rp2"	622	80	185	102	57	-	320
d3/4"-Rp1"1/4	460	60	173	88	58	-	320

Gas train "s":

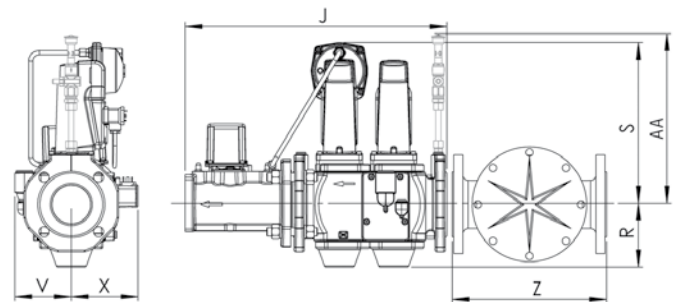

Model	J	R	S	V	X	Z	AA*
s65-DN65	490	118	300	106	126	290	365

*: for PED configuration

PACKAGING

The burner is delivered on a pallet in three packages containing:

- burner housing
- combustion head
- gas train and filter

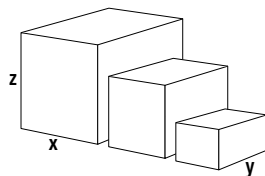

Component	Dimensions (mm)			Gross weight (kg)	
	X	Y	Z		
Burner body	800	600	850	56	
Combustion head	KN	780	265	280	12,3
	KL	1010	265	280	14,4
	KM	1010	265	280	13,4
Gas train	s65-DN65/TC	670	550	380	29
	d65-DN65/TC	670	550	380	33
	d2"-Rp2"/TC	670	550	380	22
	d1"1/2-Rp2"/TC	670	550	380	21
	d3/4"-Rp1"1/4/TC	670	550	380	12

VG5.750 M

160 ... 800 kW

Two stage progressive/modulating electronic

PRESSURE LOSS [BURNER HEAD + GAS TRAIN] (mbar)

VG5.750 M

Burner output (kW)	Natural gas G20 Hi = 10,35 kWh/m ³				
	d3/4-Rp1"1/4	d1"1/2-Rp2"	d2"-Rp2"	d65-DN65	S65-DN65
350	21	7	6	6	4
450	32	11	9	9	7
550	44	16	13	13	10
650	58	22	18	17	14
750	75	28	23	21	18
850	95	36	28	26	24

Natural gas G20

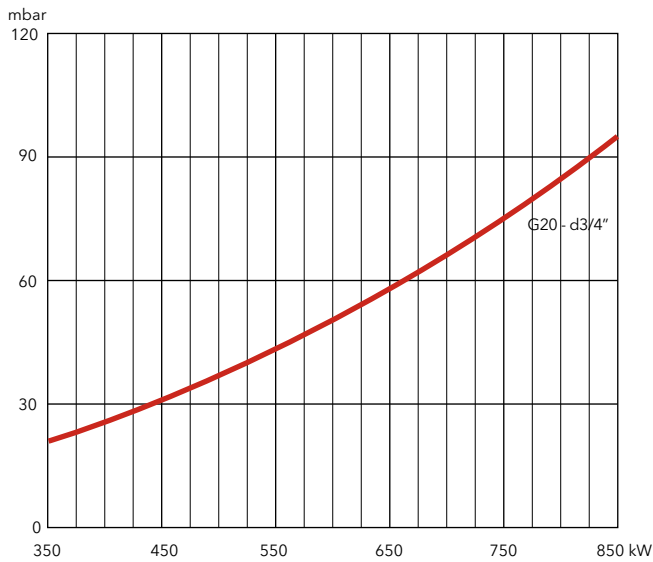

Natural gas G20

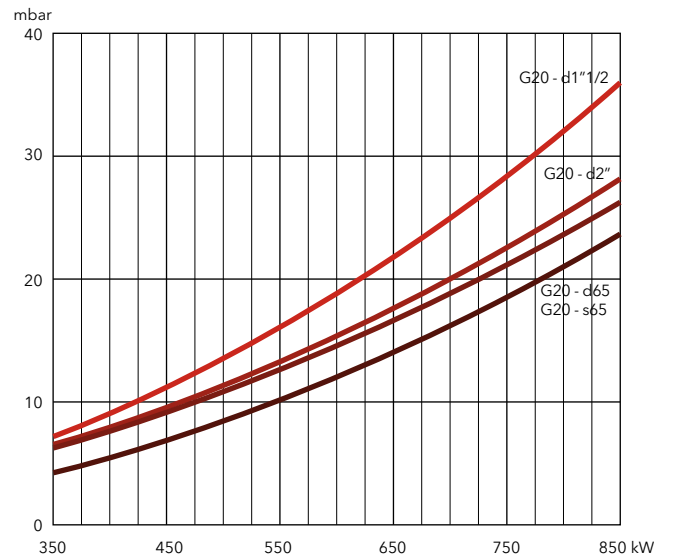



PRESSURE LOSS [BURNER HEAD + GAS TRAIN] (mbar)

VG5.750 M

Burner output (kW)	Natural gas G25 Hi = 8,83 kWh/m ³					LPG G31
	d3/4-Rp1"1/4	d1"1/2-Rp2"	d2"-Rp2"	d65-DN65	s65-DN65	d1"1/2-Rp2"
350	21	8	6	6	6	4
450	35	12	10	10	10	7
550	53	18	14	14	14	12
650	74	26	20	19	19	17
750	98	34	26	24	24	22
850	125	44	33	30	30	28

Natural gas G25

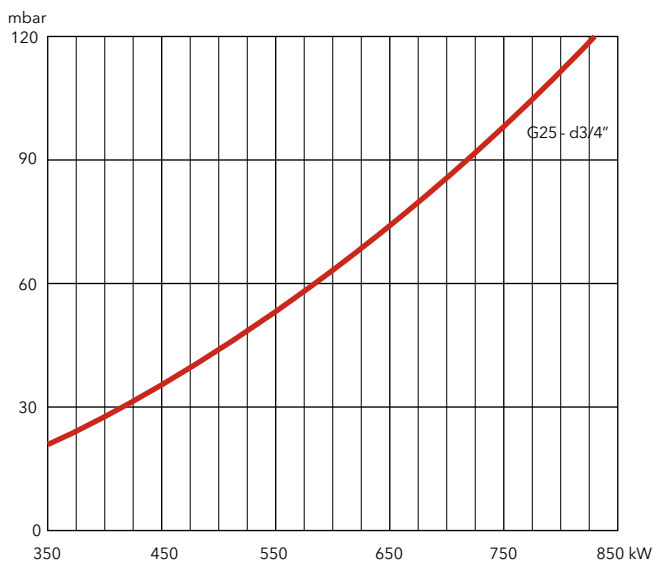

Natural gas G25

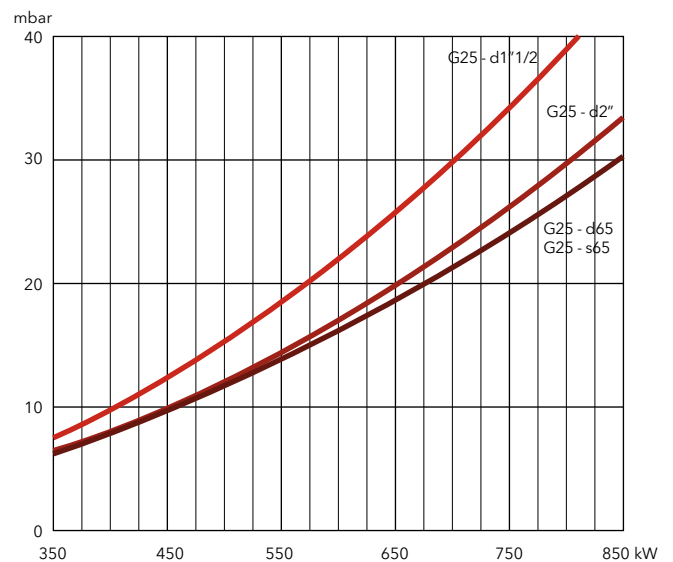

LPG

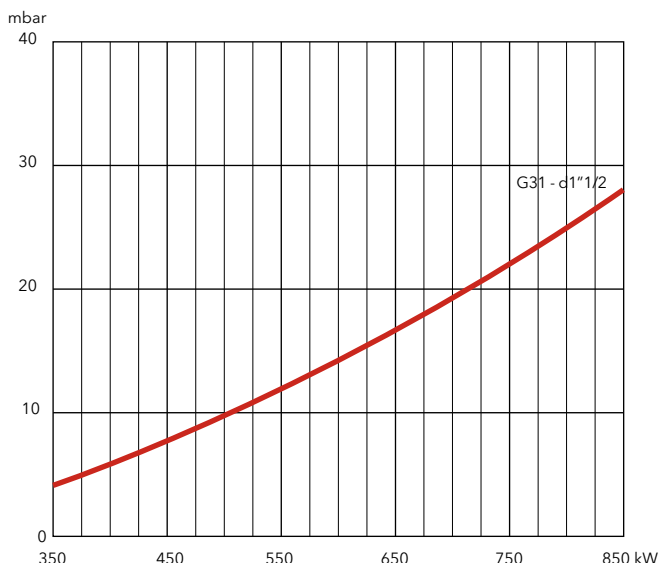

VG5.950 M / VG5.1200 M

160 ... 1160 kW

Two stage progressive/modulating electronic

- **Fuels:** natural gas (G20/G25, $H_u = 8,83...10,35 \text{ kWh/m}^3$); LPG (G31, $H_u = 25,89 \text{ kWh/m}^3$)
- **Emissions:** NOx < 70 mg/kWh (NCV), Low NOx class 3 burners according to EN676
- **Operation:** two stage progressive or modulating with the installation of a power regulator and dedicated probes (see page 218), and integrated tightness control
- **Protection level:** IP 21



TECHNICAL DATA

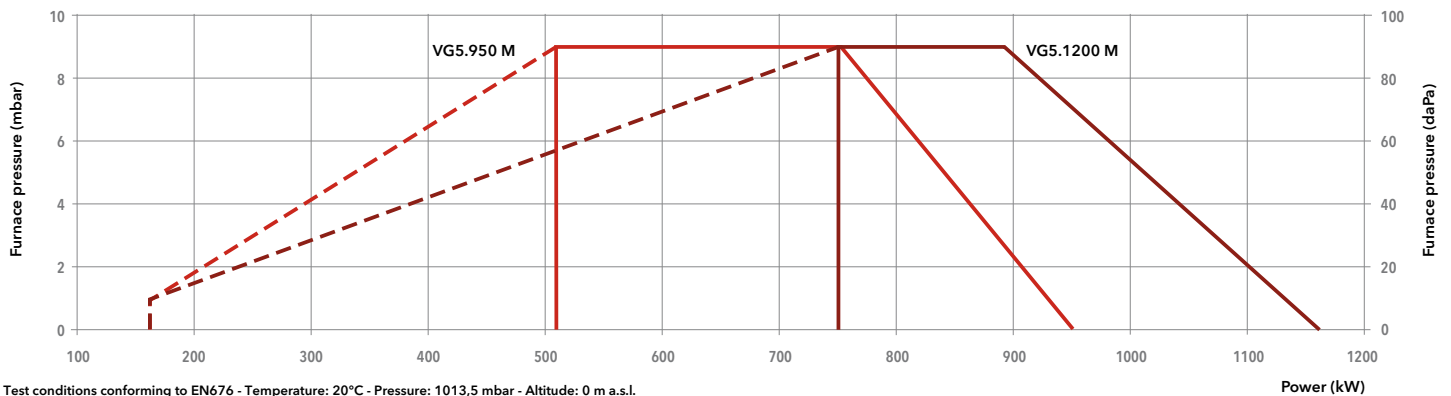

Model	VG5.950 M /TC			VG5.1200 M /TC				
Operation range	(160)510 – 950 kW			(160)750 – 1160 kW				
Gas pressure	20 – 300 mbar			20 – 300 mbar				
Control box / flame detection	BT3... / ionization			BT3... / ionization				
Fan motor	230/400 V – 50 Hz – 1,5 kW			230/400 V – 50 Hz – 1,5 kW				
Electrical consumption	55 + 1750 W			55 + 2100 W				
Acoustic level (LpA)	77 dB(A)			77 dB(A)				
CE certificate	0085 CN 0192			0085 CN 0192				
Head length		KN	KL	KM	KN	KL	KM	
Complete burner code	VGD40-065	s65-DN65/TC	3833999	3834000	3834001	3834005	3834006	3834007
	MBC1900	d65-DN65/TC	3833996	3833997	3833998	3834002	3834003	3834004
	MBC1200	d2"-Rp2"/TC	3833803	3833804	3833805	3833809	3833810	3833811
	MBC700	d1"1/2-Rp2"/TC	3833800	3833801	3833802	3833806	3833807	3833808
	MBC300	d3/4"-Rp1"1/4/TC	3834099	3834100	3834101	3834102	3834103	3834104

OTHER AVAILABLE VERSIONS

- Vent** Versions for continuous ventilation and post-ventilation
- PED** PED version for continuous operation

SCOPE OF SUPPLY

The burner is delivered in its package complete with:

- 1 burner head with flange seal and securing screws
- 1 compact gas train with gas filter; the gas filter is built-in for threaded valves (up to 2") and separated for flanged ones (DN65/80/100)
- 1 bag containing installation fittings
- 1 bag containing technical documentation (instruction manual, technical data, electrical diagram, exploded view and spare parts list)



DIMENSIONS (mm)

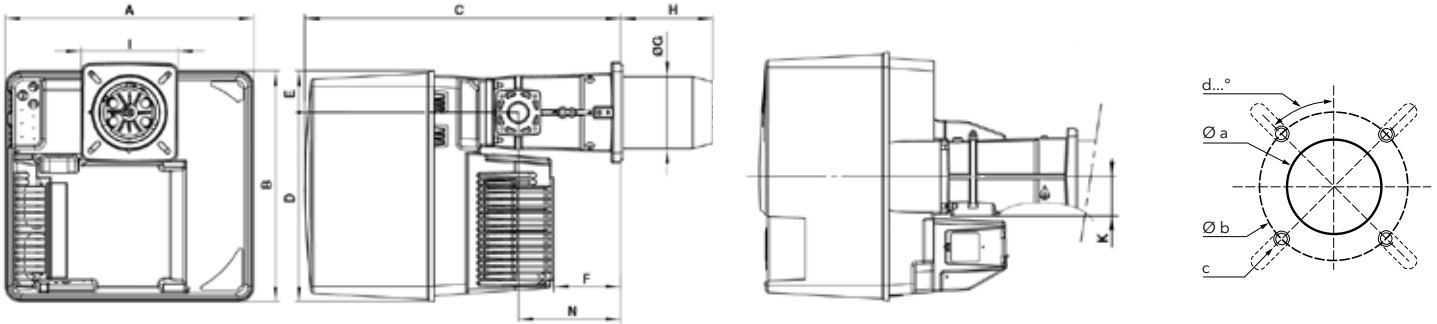

A	B	C	D	E	F	ØG	H			I	K	N
							KN	KM	KL			
581	549	752	450	99	164	170	285	395	505	230x238	89	244

Øa (mm)	b (mm)	c	d
195	220-260	M10	45°

Gas trains

Gas train "d":

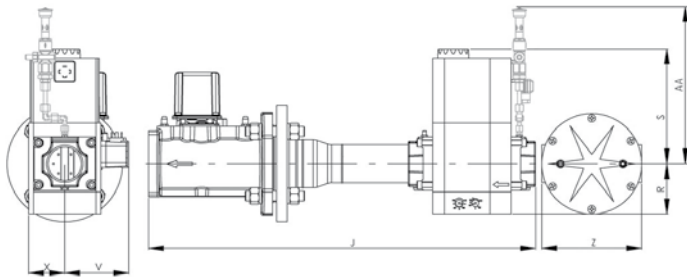

Model	J	R	S	V	X	Z	AA*
d65-DN65	490	183	245	110	98	290	385
d2"-Rp2"	700	96	330	125	81	-	385
d1"1/2-Rp2"	622	80	185	102	57	-	320
d3/4"-Rp1"1/4	460	60	173	88	58	-	320

Gas train "s":

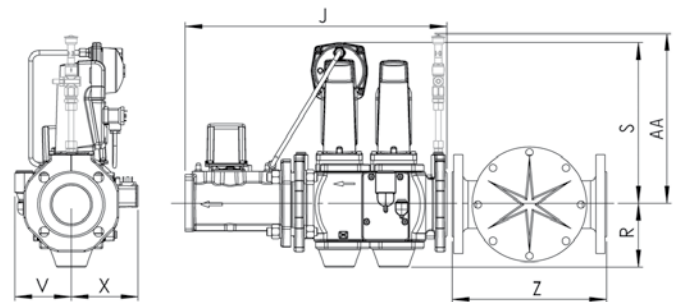

Model	J	R	S	V	X	Z	AA*
s65-DN65	490	118	300	106	126	290	365

*: for PED configuration

PACKAGING

The burner is delivered on a pallet in three packages containing:

- burner housing
- combustion head
- gas train and filter

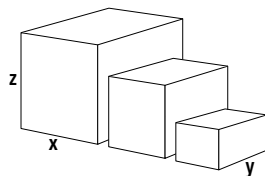

Component		Dimensions (mm)			Gross weight (kg)
		X	Y	Z	
Burner body	VG5.950 M	800	600	850	56
	VG5.1200 M	800	600	850	56
Combustion head	KN	780	265	280	12,3
	KL	1010	265	280	14,4
	KM	1010	265	280	13,4
Gas train	s65-DN65/TC	670	550	380	29
	d65-DN65/TC	670	550	380	33
	d2"-Rp2"/TC	670	550	380	22
	d1"1/2-Rp2"/TC	670	550	380	21
	d3/4"-Rp1"1/4/TC	670	550	380	12

VG5.950 M / VG5.1200 M

160 ... 1160 kW

Two stage progressive/modulating electronic

PRESSURE LOSS [BURNER HEAD + GAS TRAIN] (mbar)

VG5.950 M

Burner output (kW)	Natural gas G20 Hi = 10,35 kWh/m ³					Natural gas G25 Hi = 8,83 kWh/m ³					LPG G31
	d3/4-Rp1"1/4	d1"1/2-Rp2"	d2"-Rp2"	d65-DN65	s65-DN65	d3/4-Rp1"1/4	d1"1/2-Rp2"	d2"-Rp2"	d65-DN65	s65-DN65	d1"1/2-Rp2"
450	22	8	7	4	4	27	10	8	5	4	5
550	31	11	9	6	6	39	14	11	8	6	7
650	43	15	11	9	9	54	19	14	11	9	9
750	57	19	14	12	12	63	25	17	14	12	11
850	73	24	17	15	15	94	31	21	18	15	14
950	93	30	21	18	18	119	39	26	23	19	18

Natural gas G20

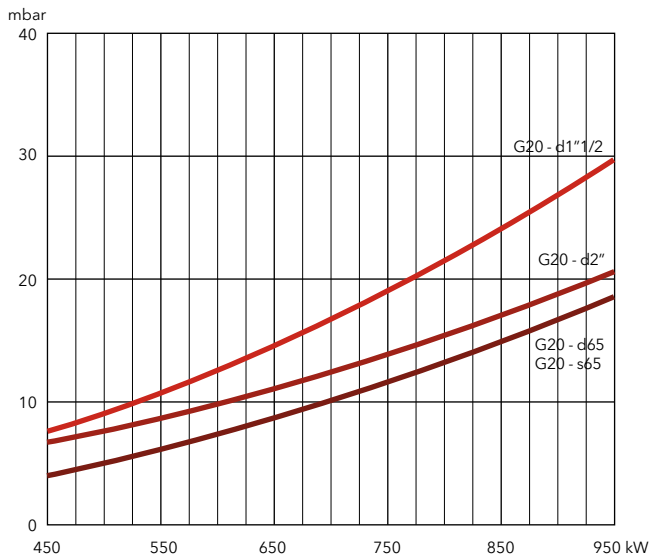

Natural gas G25

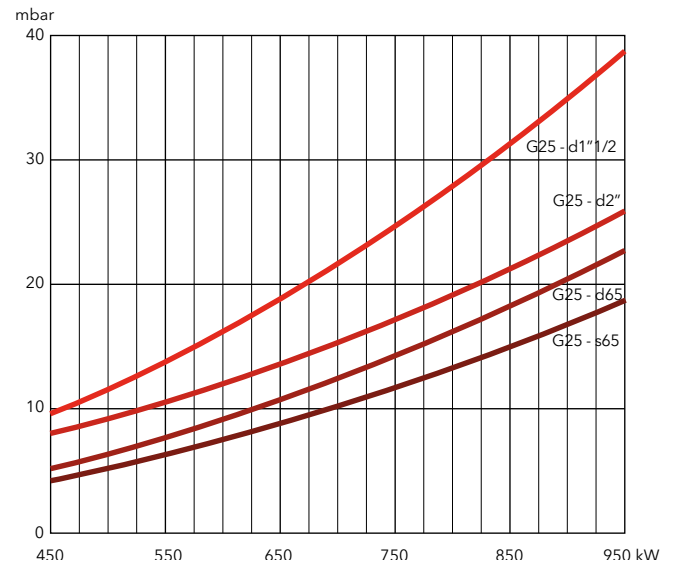

Natural gas G20, G25

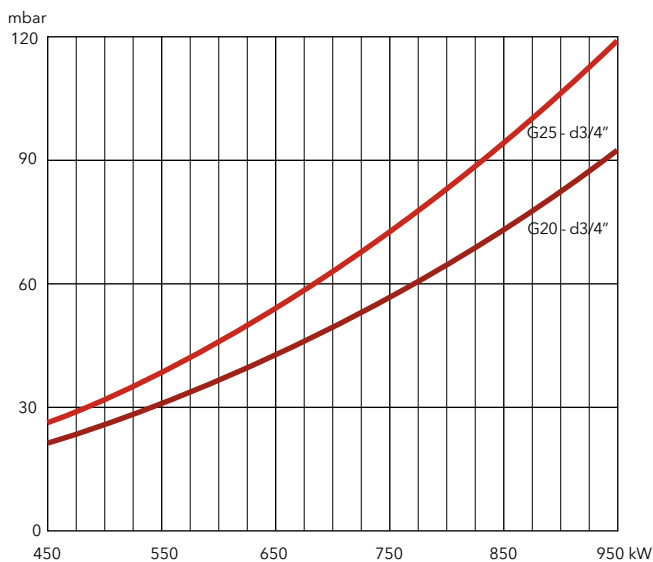

LPG

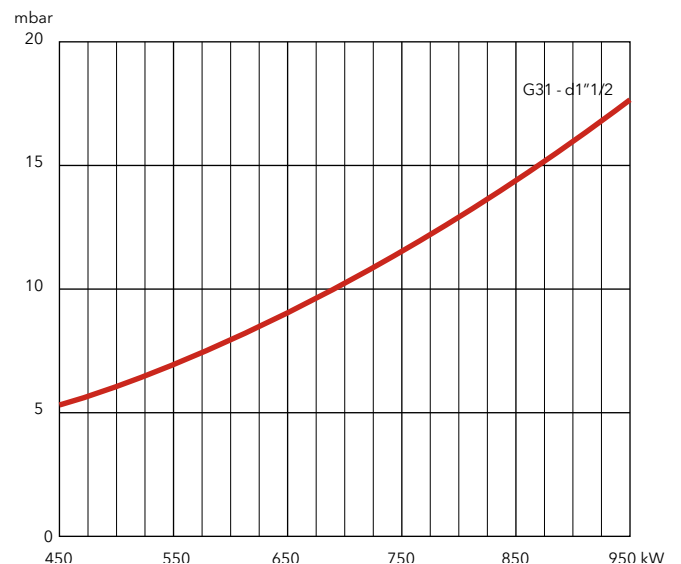



PRESSURE LOSS [BURNER HEAD + GAS TRAIN] (mbar)

VG5.1200 M

Burner output (kW)	Natural gas G20 Hi = 10,35 kWh/m ³					Natural gas G25 Hi = 8,83 kWh/m ³					LPG G31
	d3/4-Rp1"1/4	d1"1/2-Rp2"	d2"-Rp2"	d65-DN65	s65-DN65	d3/4-Rp1"1/4	d1"1/2-Rp2"	d2"-Rp2"	d65-DN65	s65-DN65	d1"1/2-Rp2"
700	40	16	12	10	10	60	21	14	10	12	10
800	53	20	14	13	13	79	27	17	13	15	12
900	68	25	17	16	16	100	34	21	16	19	15
1000	84	31	21	20	20	126	42	26	20	24	18
1100	103	37	25	24	24	154	50	31	24	29	22
1200	123	44	29	29	29	186	59	36	29	34	26

Natural gas G20

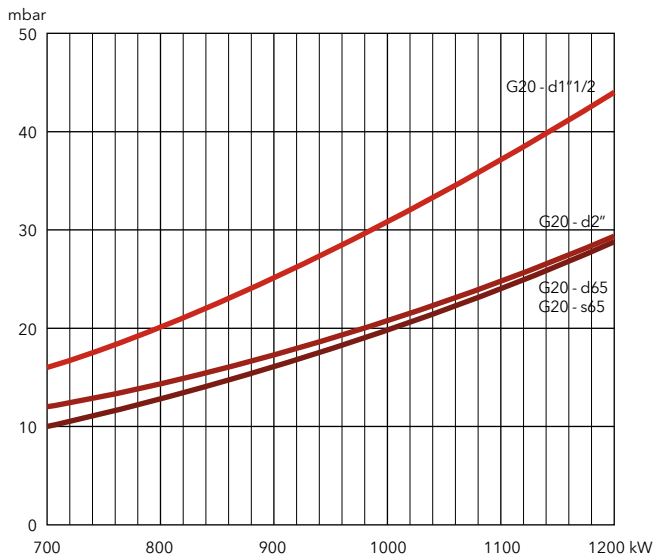

Natural gas G25

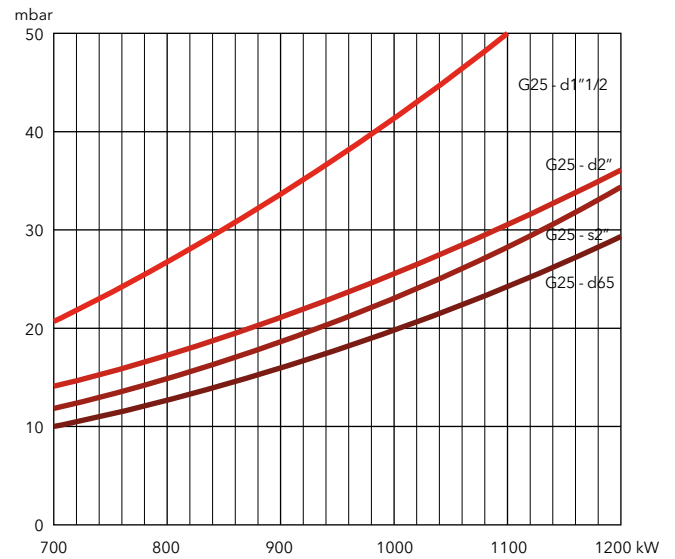

Natural gas G20, G25

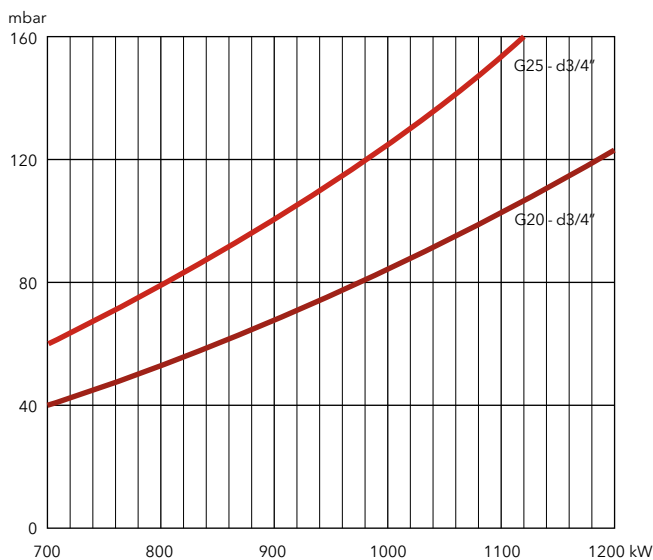

LPG

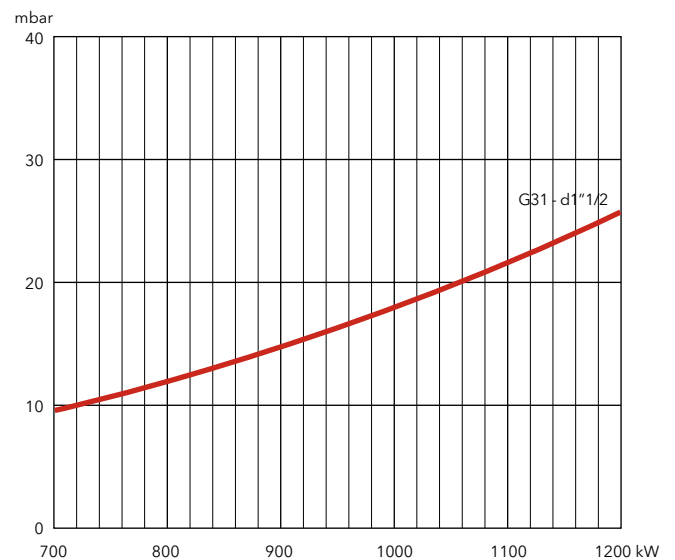

VG6.1600 M / VG6.2100 M

240 ... 1900 kW

Two stage progressive/modulating electronic



- **Fuels:** natural gas (G20/G25, $H_u = 8,83...10,35 \text{ kWh/m}^3$); LPG (G31, $H_u = 25,89 \text{ kWh/m}^3$)
- **Emissions:** $\text{NO}_x < 70 \text{ mg/kWh (NCV)}$, Low NO_x class 3 burners according to EN676
- **Operation:** two stage progressive or modulating with the installation of a power regulator and dedicated probes (see page 218), and integrated tightness control
- **Protection level:** IP 21

TECHNICAL DATA

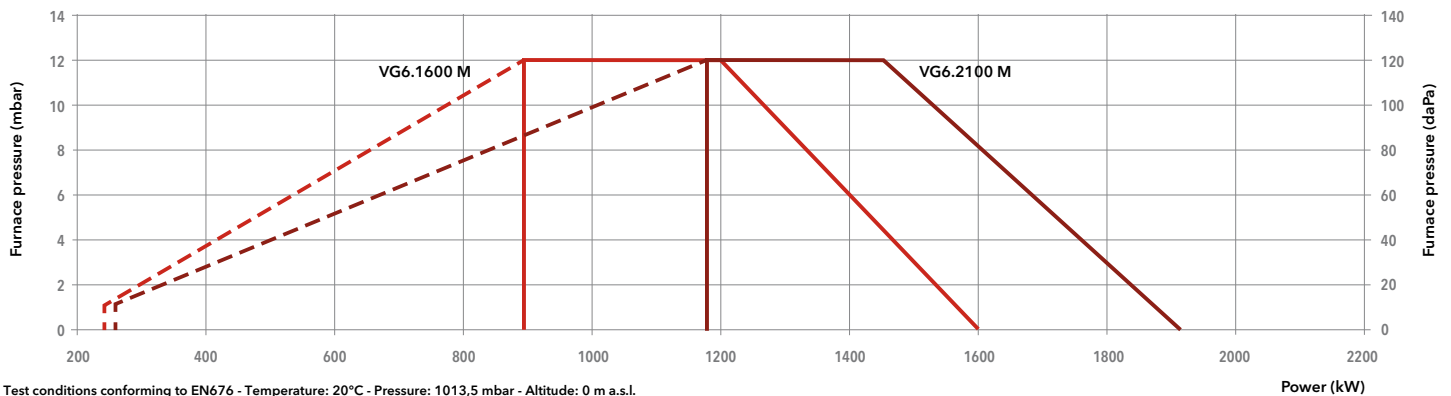

Model	VG6.1600 M /TC			VG6.2100 M /TC			
Operation range	(240) 890 - 1600 kW			(260) 1180 - 1900 kW			
Gas pressure	20 - 300 mbar			20 - 300 mbar			
Control box / flame detection	BT3... / IRD 1020.1			BT3... / IRD 1020.1			
Fan motor	230/400 V - 50 Hz - 2,2 kW			230/400 V - 50 Hz - 2,5 kW			
Electrical consumption	55 + 2600 W			55 + 3400 W			
Acoustic level (LpA)	77,2 dB(A)			79 dB(A)			
CE certificate	0085 CN 0192			0085 CN 0192			
Head length	KN	KL	KM	KN	KL	KM	
Complete	VGD 40-065 s65-DN65/TC	3833938	3833939	3833940	3833934	3833933	3833930
burner code	MBC1900 d65-DN65/TC	3833836	3833837	3833838	3833845	3833846	3833847
	MBC1200 d2"-Rp2"/TC	3833833	3833834	3833835	3833842	3833843	3833844
	MBC700 d1"1/2-Rp2"/TC	3833830	3833831	3833832	3833839	3833840	3833841

OTHER AVAILABLE VERSIONS

- Vent** Versions for continuous ventilation and post-ventilation
- PED** PED version for continuous operation

SCOPE OF SUPPLY

The burner is delivered in its package complete with:

- 1 burner head with flange seal and securing screws
- 1 compact gas train with gas filter; the gas filter is built-in for threaded valves (up to 2") and separated for flanged ones (DN65/80/100)
- 1 bag containing installation fittings
- 1 bag containing technical documentation (instruction manual, technical data, electrical diagram, exploded view and spare parts list)



DIMENSIONS (mm)

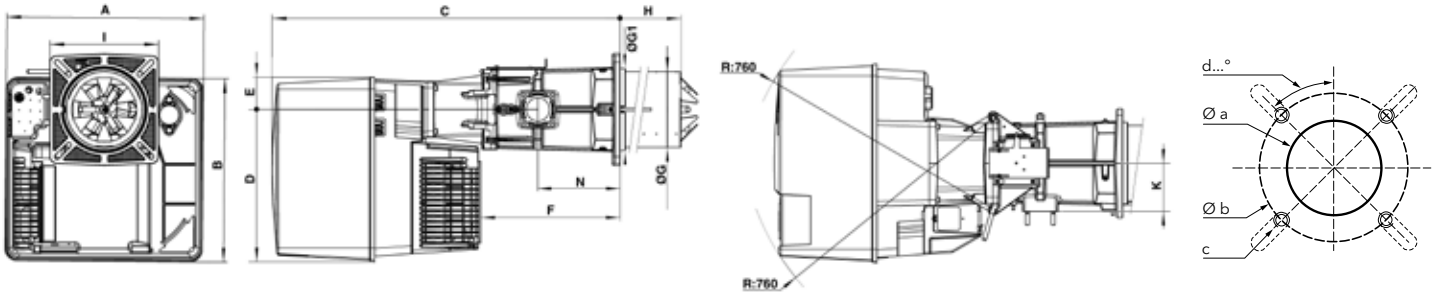

A	B	C	D	E	F	ØG	ØG1	H			I	K	N
								KN	KM	KL			
592	553	1050	456	97	421	227	245	310	410	510	326x335	144	247

Øa (mm)	b (mm)	c	d
250	300-400	M12	45°

Gas trains

Gas train "d":

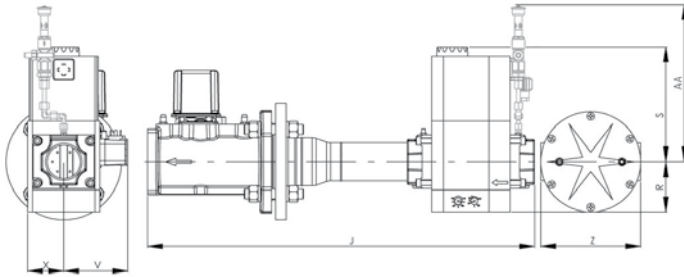

Model	J	R	S	V	X	Z	AA*
d65-DN65	490	183	245	110	98	290	385
d2"-Rp2"	700	96	330	125	81	-	385
d1"1/2-Rp2"	622	80	185	102	57	-	320

Gas train "s":

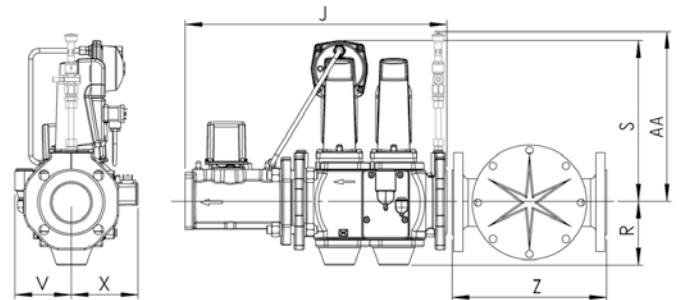

Model	J	R	S	V	X	Z	AA*
s65-DN65	490	118	300	106	126	290	365

*: for PED configuration

PACKAGING

The burner is delivered on a pallet in three packages containing:

- burner housing
- combustion head
- gas train and filter

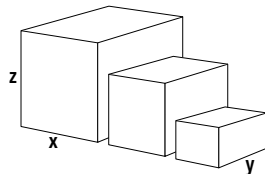

Component		Dimensions (mm)			Gross weight (kg)
		X	Y	Z	
Burner body	VG6.1600 M	800	600	850	56
	VG6.2100 M	800	600	850	56
Combustion head	KN	1000	380	420	26,7
	KL	1100	380	430	29,4
	KM	1100	380	430	28
Gas train	s65-DN65/TC	790	600	500	29,4
	d65-DN65/TC	670	550	380	33
	d2"-Rp2"/TC	670	550	380	22
	d1"1/2-Rp2"/TC	670	550	380	21

VG6.1600 M / VG6.2100 M

240 ... 1900 kW

Two stage progressive/modulating electronic

PRESSURE LOSS [BURNER HEAD + GAS TRAIN] (mbar)

VG6.1600 M

Burner output (kW)	Natural gas G20 Hi = 10,35 kWh/m ³				Natural gas G25 Hi = 8,83 kWh/m ³				LPG G31 Hi = 25,89 kWh/m ³
	d1"1/2-Rp2"	d2"-Rp2"	d65-DN65	s65-DN65	d1"1/2-Rp2"	d2"-Rp2"	d65-DN65	s65-DN65	d1"1/2-Rp2"
800	16	9	6	6	22	12	8	8	8
1000	25	13	10	9	34	18	12	12	12
1200	35	18	14	13	48	24	18	18	17
1400	47	24	19	18	64	32	24	24	22
1600	61	31	25	23	83	42	31	31	29

Natural gas G20

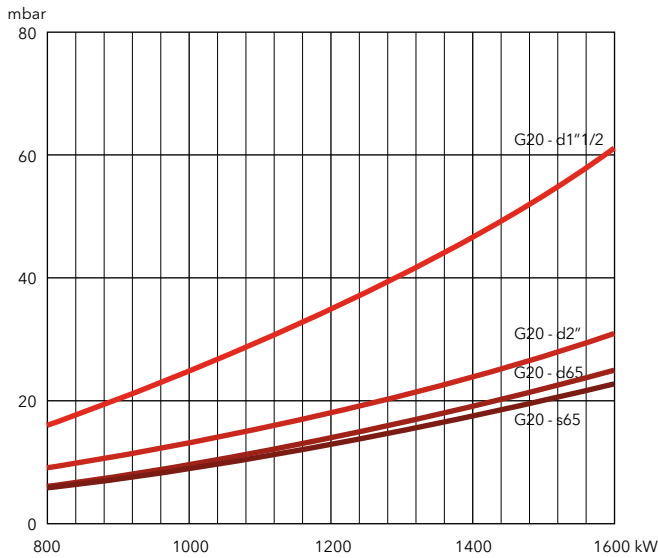

Natural gas G25

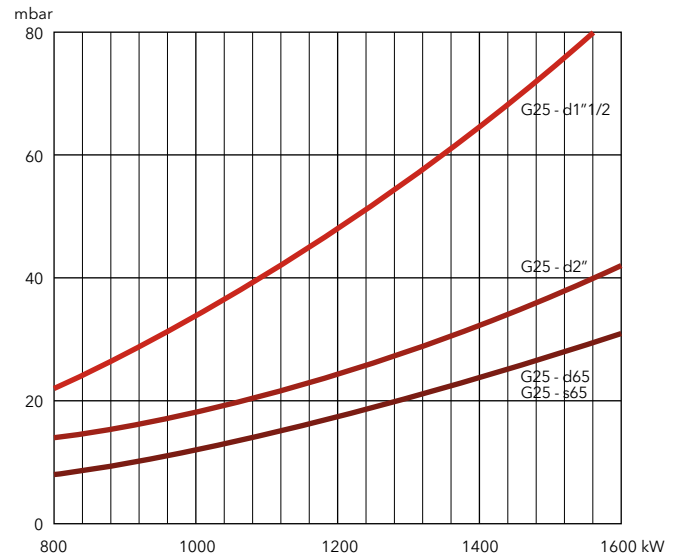

LPG

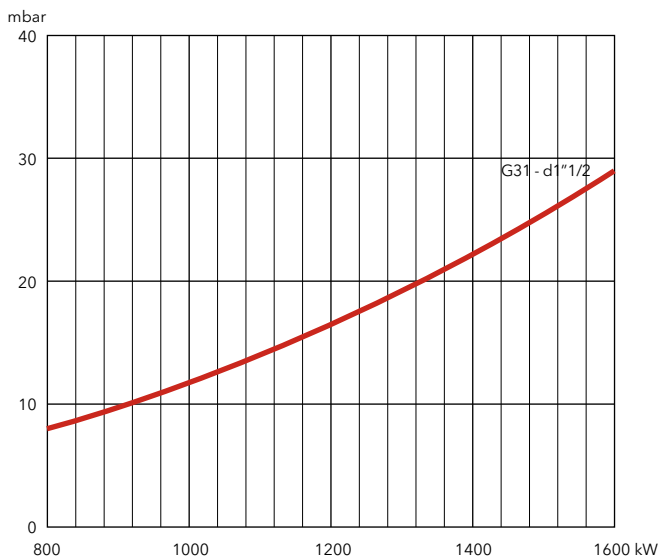



PRESSURE LOSS [BURNER HEAD + GAS TRAIN] (mbar)

VG6.2100 M

Burner output (kW)	Natural gas G20 Hi = 10,35 kWh/m ³				Natural gas G25 Hi = 8,83 kWh/m ³				LPG G31 Hi = 25,89 kWh/m ³	
	d1"1/2-Rp2"	d2"-Rp2"	d65-DN65	s65-DN65	d1"1/2-Rp2"	d2"-Rp2"	d65-DN65	s65-DN65	d1"1/2-Rp2"	d2"-Rp2"
1100	28	15	12	11	39	21	15	15	13	9
1300	39	21	16	16	54	29	21	22	18	11
1500	51	27	21	21	71	37	28	29	23	14
1700	64	34	27	27	91	47	36	37	29	17
1900	80	41	34	34	114	59	45	46	36	20

Natural gas G20

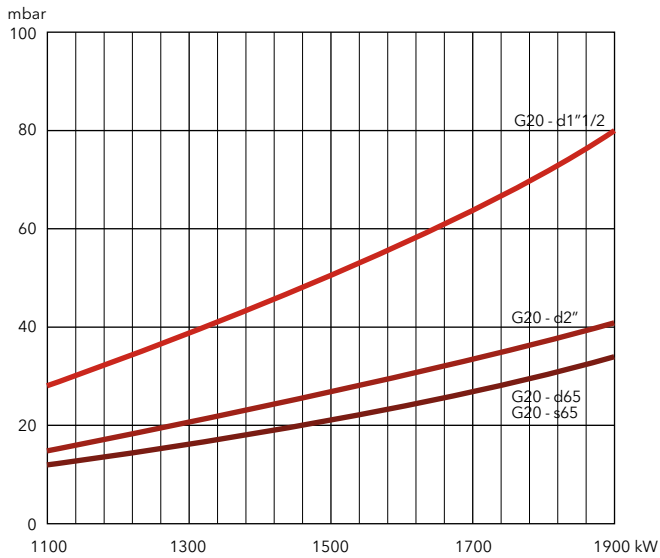

Natural gas G25

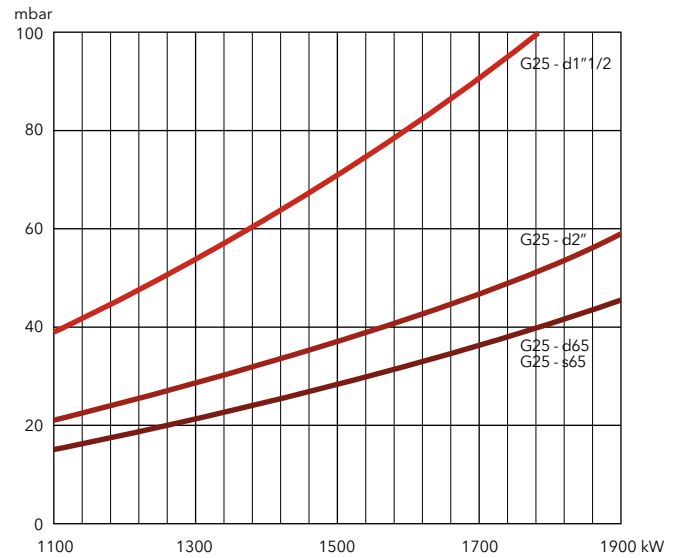

LPG

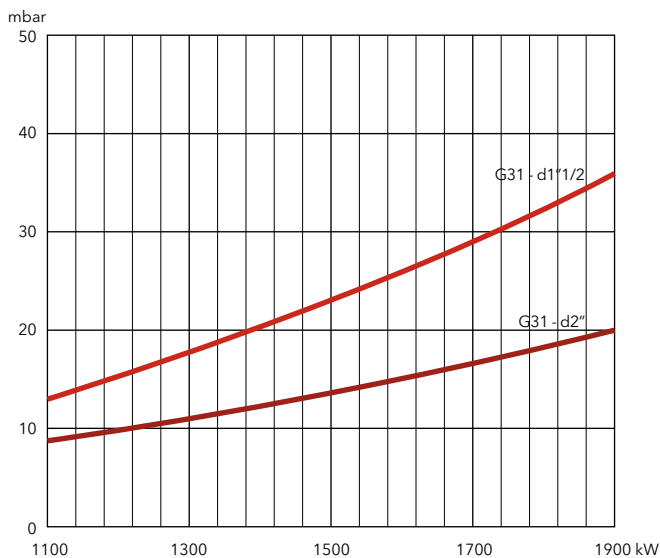

VG5.750 M V

160 ... 800 kW

Two stage progressive/modulating electronic + fan speed control



- **Fuels:** natural gas (G20/G25, $H_u = 8,83...10,35 \text{ kWh/m}^3$); LPG (G31, $H_u = 25,89 \text{ kWh/m}^3$)
- **Emissions:** $\text{NO}_x < 70 \text{ mg/kWh}$ (NCV), Low NO_x class 3 burners according to EN676
- **Operation:** two stage progressive or modulating with the installation of a power regulator and dedicated probes (see page 218), and integrated tightness control
- **Protection level:** IP 21

TECHNICAL DATA

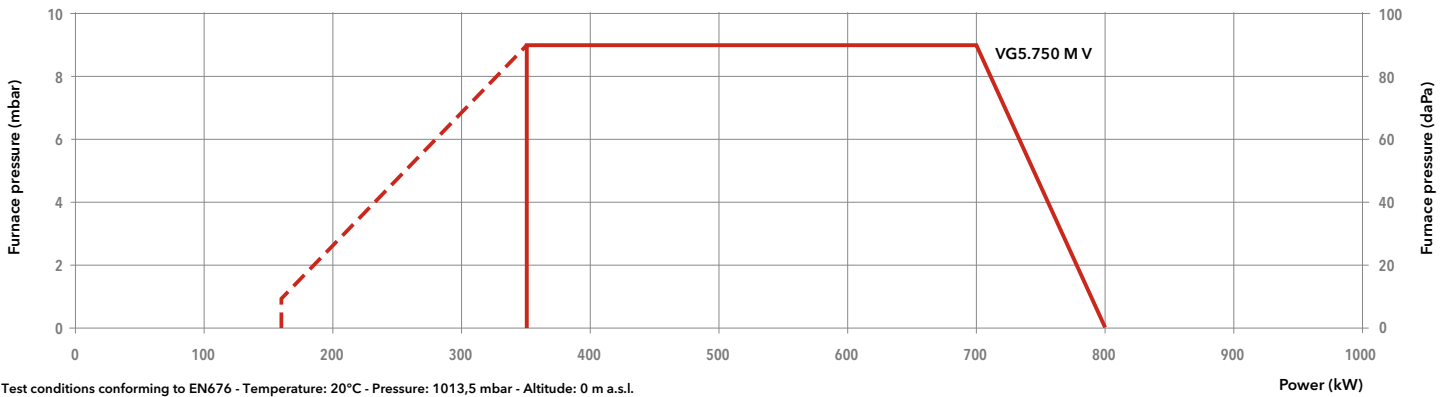

Model	VG5.750 M V /TC		
Operation range	(160) 350 – 800 kW		
Gas pressure	20 – 300 mbar		
Control box / flame detection	BT3... / ionization		
Fan motor	230/400 V – 50 Hz – 1,1 kW		
Electrical consumption	53 + 1700 W		
Acoustic level (LpA)	77 dB(A)		
CE certificate	0476 DN 1270		
Head length	KN	KL	KM
VGD40-065	s65-DN65/TC	3837063	3837068
MBC1900	d65-DN65/TC	3837064	3837069
MBC1200	d2"-Rp2"/TC	3837065	3837070
MBC700	d1"1/2-Rp2"/TC	3837066	3837071
MBC300	d3/4"-Rp1"1/4/TC	3837067	3837072
Complete burner code			3837073
			3837074
			3837075
			3837076
			3837077

OTHER AVAILABLE VERSIONS

Vent Versions for continuous ventilation and post-ventilation

PED PED version for continuous operation

SCOPE OF SUPPLY

The burner is delivered in its package complete with:

- 1 burner head with flange seal and securing screws
- 1 compact gas train with gas filter; the gas filter is built-in for threaded valves (up to 2") and separated for flanged ones (DN65/80/100)
- 1 bag containing installation fittings
- 1 bag containing technical documentation (instruction manual, technical data, electrical diagram, exploded view and spare parts list)



DIMENSIONS (mm)

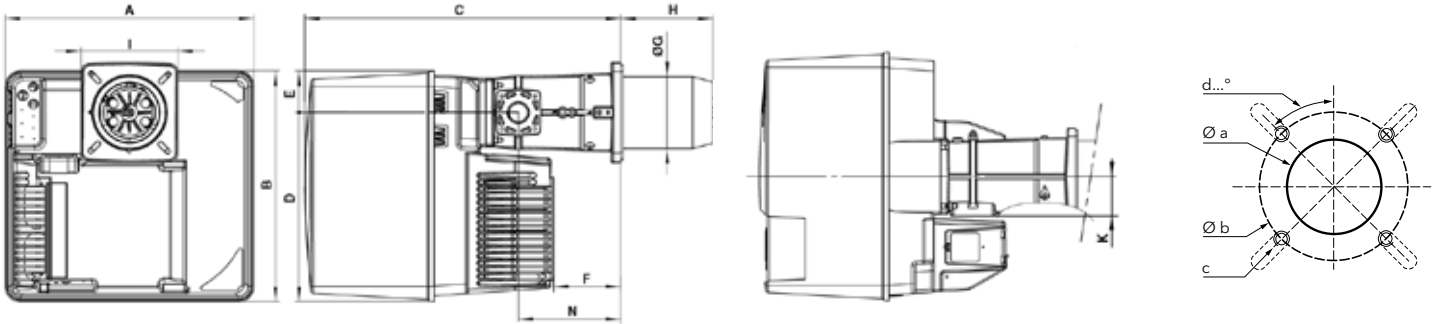

A	B	C	D	E	F	ØG	H			I	K	N
							KN	KM	KL			
581	549	752	450	99	164	170	285	395	505	230x238	89	244

Øa (mm)	b (mm)	c	d
195	220-260	M10	45°

Gas trains

Gas train "d":

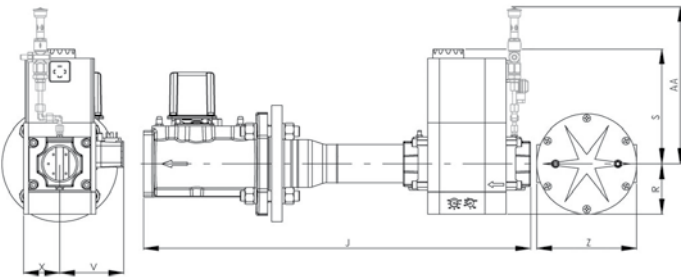

Model	J	R	S	V	X	Z	AA*
d65-DN65	490	183	245	110	98	290	385
d2"-Rp2"	700	96	330	125	81	-	385
d1"1/2-Rp2"	622	80	185	102	57	-	320
d3/4"-Rp1"1/4	460	60	173	88	58	-	320

Gas train "s":

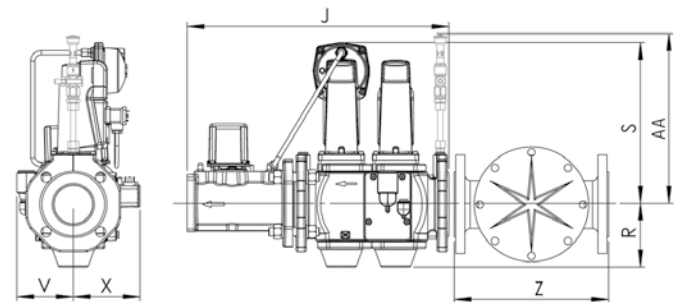

Model	J	R	S	V	X	Z	AA*
s65-DN65	490	118	300	106	126	290	365

*: for PED configuration

PACKAGING

The burner is delivered on a pallet in three packages containing:

- burner housing
- combustion head
- gas train and filter

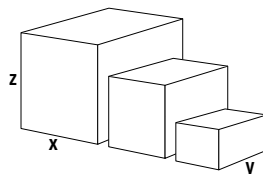

Component	Dimensions (mm)			Gross weight (kg)	
	X	Y	Z		
Burner body	800	600	850	56	
Combustion head	KN	780	265	280	12,3
	KL	1010	265	280	14,4
	KM	1010	265	280	13,4
Gas train	s65-DN65/TC	670	550	380	29
	d65-DN65/TC	670	550	380	33
	d2"-Rp2"/TC	670	550	380	22
	d1"1/2-Rp2"/TC	670	550	380	21
	d3/4"-Rp1"1/4/TC	670	550	380	12

VG5.750 M V

160 ... 800 kW

Two stage progressive/modulating electronic + fan speed control

PRESSURE LOSS [BURNER HEAD + GAS TRAIN] (mbar)

VG5.750 M V

Burner output (kW)	Natural gas G20 Hi = 10,35 kWh/m ³				
	d3/4-Rp1"1/4	d1"1/2-Rp2"	d2"-Rp2"	d65-DN65	S65-DN65
350	21	7	6	6	4
450	32	11	9	9	7
550	44	16	13	13	10
650	58	22	18	17	14
750	75	28	23	21	18
850	95	36	28	26	24

Natural gas G20

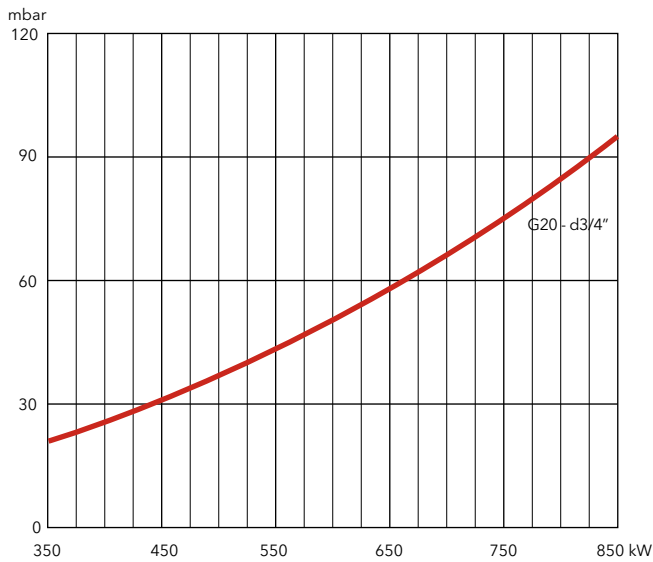

Natural gas G20

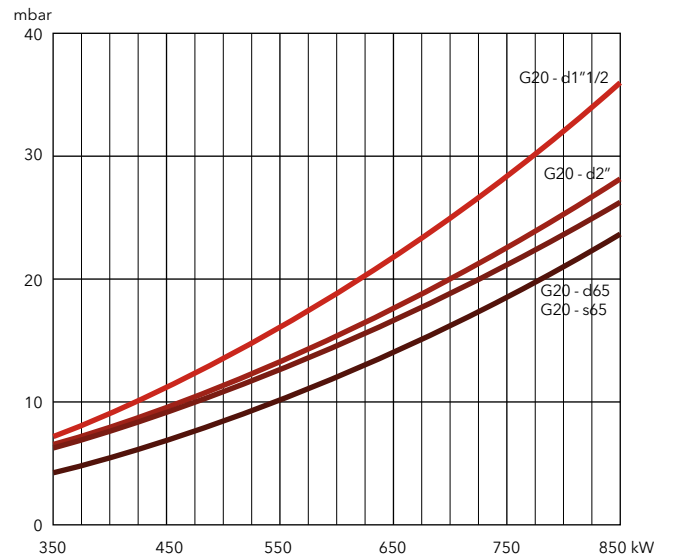



PRESSURE LOSS [BURNER HEAD + GAS TRAIN] (mbar)

VG5.750 M V

Burner output (kW)	Natural gas G25 Hi = 8,83 kWh/m ³					LPG G31
	d3/4-Rp1"1/4	d1"1/2-Rp2"	d2"-Rp2"	d65-DN65	s65-DN65	d1"1/2-Rp2"
350	21	8	6	6	6	4
450	35	12	10	10	10	7
550	53	18	14	14	14	12
650	74	26	20	19	19	17
750	98	34	26	24	24	22
850	125	44	33	30	30	28

Natural gas G25

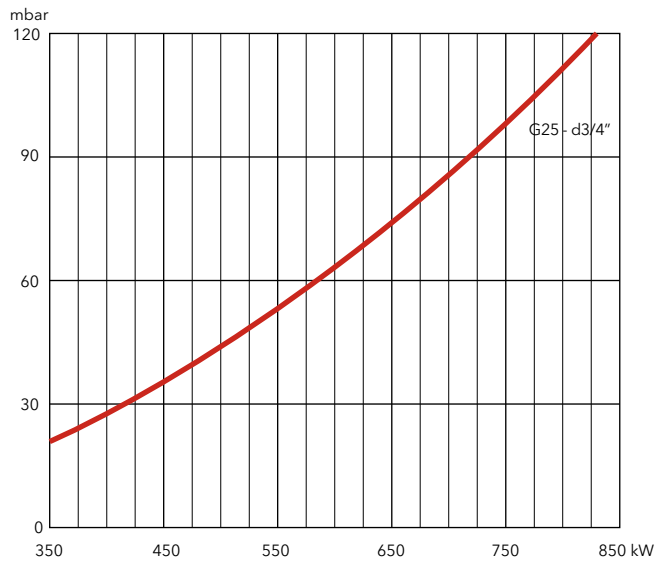

Natural gas G25

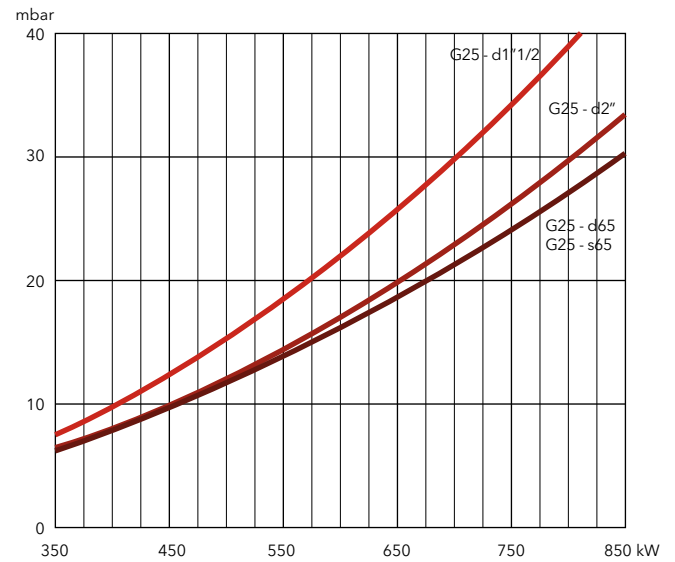

LPG

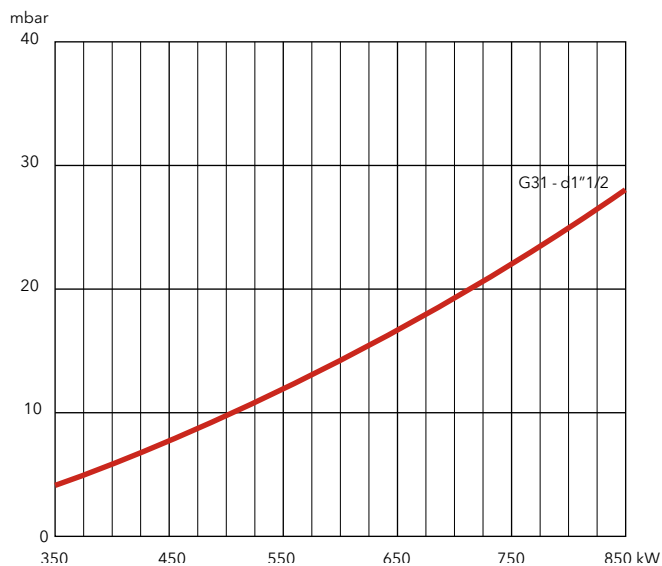

VG5.950 M V / VG5.1200 M V

160 ... 1160 kW

Two stage progressive/modulating electronic + fan speed control



- **Fuels:** natural gas (G20/G25, $H_u = 8,83...10,35 \text{ kWh/m}^3$); LPG (G31, $H_u = 25,89 \text{ kWh/m}^3$)
- **Emissions:** NOx < 70 mg/kWh (NCV), Low NOx class 3 burners according to EN676
- **Operation:** two stage progressive or modulating with the installation of a power regulator and dedicated probes (see page 218), fan speed control and integrated tightness control
- **Protection level:** IP 21

TECHNICAL DATA

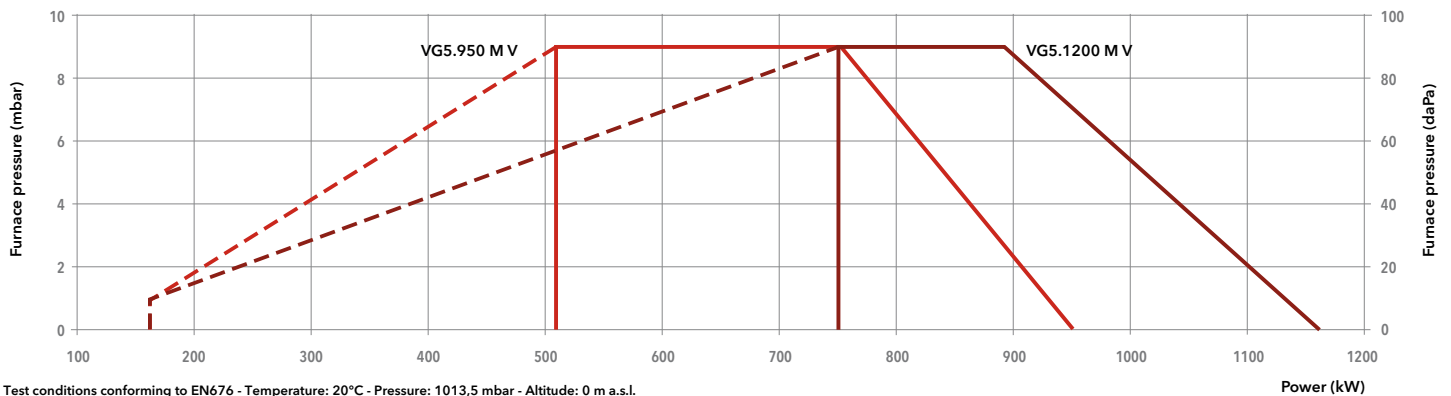

Model	VG5.950 M V /TC			VG5.1200 M V /TC				
Operation range	(160) 510 – 950 kW			(160) 750 – 1160 kW				
Gas pressure	20 – 300 mbar			20 – 300 mbar				
Control box / flame detection	BT3... / ionization			BT3... / ionization				
Fan motor	230/400 V – 50 Hz – 1,5 kW			230/400 V – 50 Hz – 1,5 kW				
Electrical consumption	55 + 1750 W			55 + 2100 W				
Acoustic level (LpA)	77 dB(A)			77 dB(A)				
CE certificate	0085 CN 0192			0085 CN 0192				
Head length		KN	KL	KM	KN	KL	KM	
Complete burner code	VGD40-065	s65-DN65/TC	3835235	3835245	3835255	3835240	3835250	3835260
	MBC1900	d65-DN65/TC	3835236	3835246	3835256	3835241	3835251	3835261
	MBC1200	d2"-Rp2"/TC	3835237	3835247	3835257	3835242	3835252	3835262
	MBC700	d1"1/2-Rp2"/TC	3835238	3835248	3835258	3835243	3835253	3835263
	MBC300	d3/4"-Rp1"1/4/TC	3835239	3835249	3835259	3835244	3835254	3835264

OTHER AVAILABLE VERSIONS

- Vent** Versions for continuous ventilation and post-ventilation
- PED** PED version for continuous operation

SCOPE OF SUPPLY

The burner is delivered in its package complete with:

- 1 burner head with flange seal and securing screws
- 1 compact gas train with gas filter; the gas filter is built-in for threaded valves (up to 2") and separated for flanged ones (DN65/80/100)
- 1 bag containing installation fittings
- 1 bag containing technical documentation (instruction manual, technical data, electrical diagram, exploded view and spare parts list)



DIMENSIONS (mm)

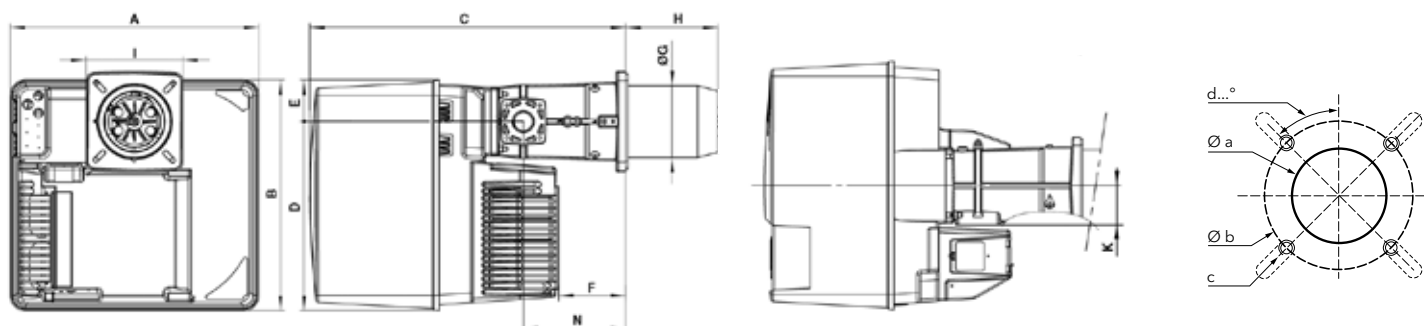

A	B	C	D	E	F	ØG	H			I	K	N
							KN	KM	KL			
581	549	752	450	99	164	170	285	395	505	230x238	89	244

Øa (mm)	b (mm)	c	d
195	220-260	M10	45°

Gas trains

Gas train "d":

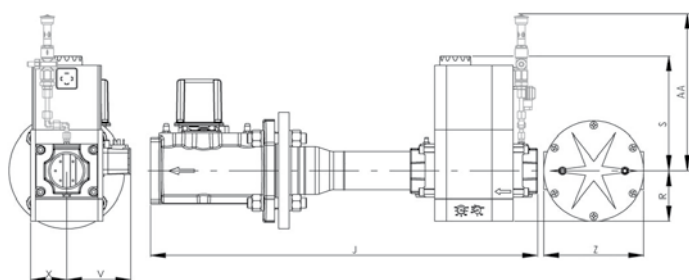

Model	J	R	S	V	X	Z	AA*
d65-DN65	490	183	245	110	98	290	385
d2"-Rp2"	700	96	330	125	81	-	385
d1"1/2-Rp2"	622	80	185	102	57	-	320
d3/4"-Rp1"1/4	460	60	173	88	58	-	320

Gas train "s":

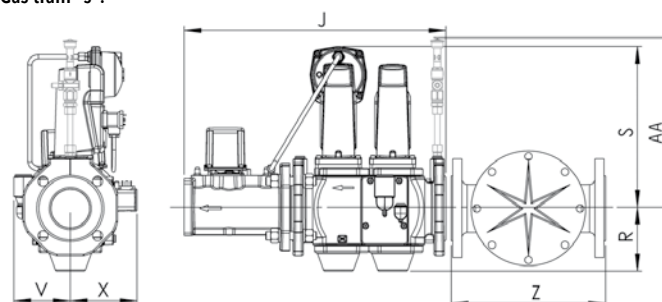

Model	J	R	S	V	X	Z	AA*
s65-DN65	490	118	300	106	126	290	365

*: for PED configuration

PACKAGING

The burner is delivered on a pallet in three packages containing:

- burner housing
- combustion head
- gas train and filter

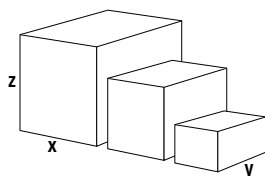

Component		Dimensions (mm)			Gross weight (kg)
		X	Y	Z	
Burner body	VG5.950 M V	800	600	850	56
	VG5.1200 M V	800	600	850	56
Combustion head	KN	780	265	280	12,3
	KL	1010	265	280	14,4
	KM	1010	265	280	13,4
Gas train	s65-DN65/TC	670	550	380	29
	d65-DN65/TC	670	550	380	33
	d2"-Rp2"/TC	670	550	380	22
	d1"1/2-Rp2"/TC	670	550	380	21
	d3/4"-Rp1"1/4/TC	590	290	180	12

VG5.950 M V / VG5.1200 M V

160 ... 1160 kW

Two stage progressive/modulating electronic + fan speed control

PRESSURE LOSS [BURNER HEAD + GAS TRAIN] (mbar)

VG5.950 M V

Burner output (kW)	Natural gas G20 Hi = 10,35 kWh/m ³					Natural gas G25 Hi = 8,83 kWh/m ³					LPG G31
	d3/4-Rp1"1/4	d1"1/2-Rp2"	d2"-Rp2"	d65-DN65	s65-DN65	d3/4-Rp1"1/4	d1"1/2-Rp2"	d2"-Rp2"	d65-DN65	s65-DN65	d1"1/2-Rp2"
450	22	8	7	4	4	27	10	8	5	4	5
550	31	11	9	6	6	39	14	11	8	6	7
650	43	15	11	9	9	54	19	14	11	9	9
750	57	19	14	12	12	63	25	17	14	12	11
850	73	24	17	15	15	94	31	21	18	15	14
950	93	30	21	18	18	119	39	26	23	19	18

Natural gas G20

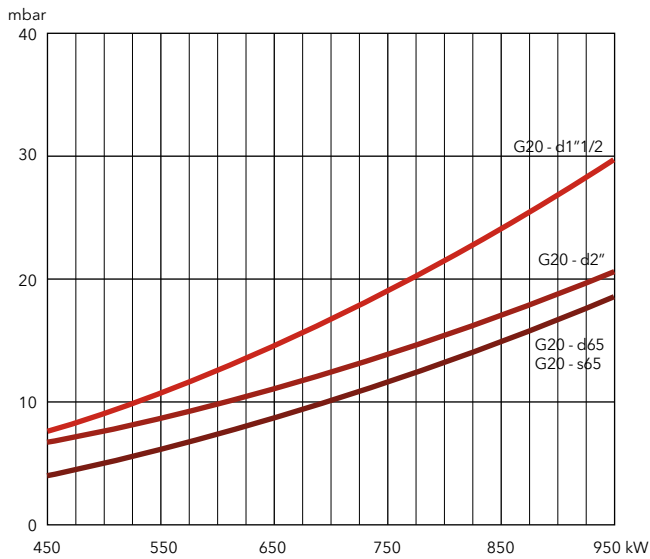

Natural gas G25

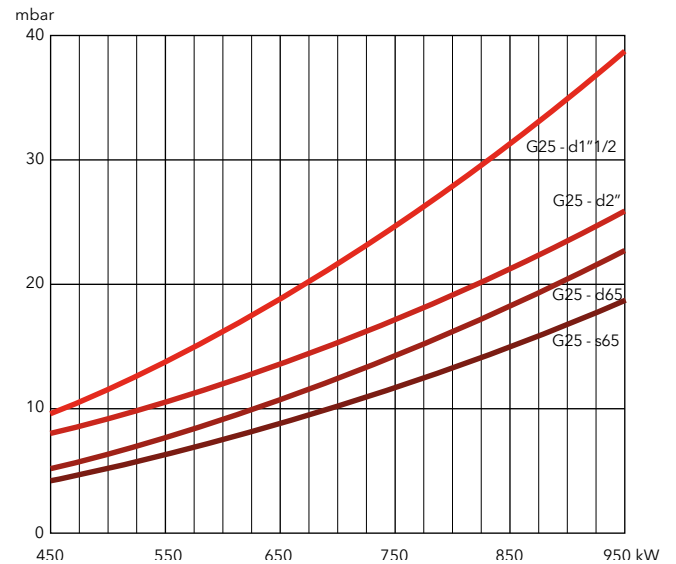

Natural gas G20, G25

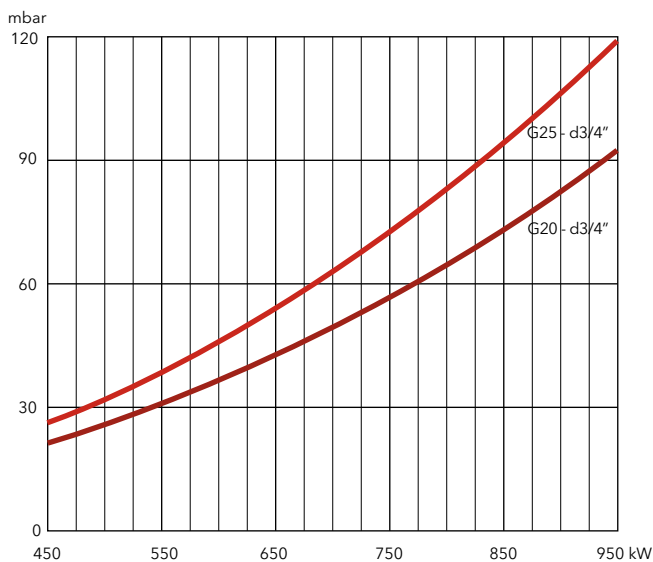

LPG

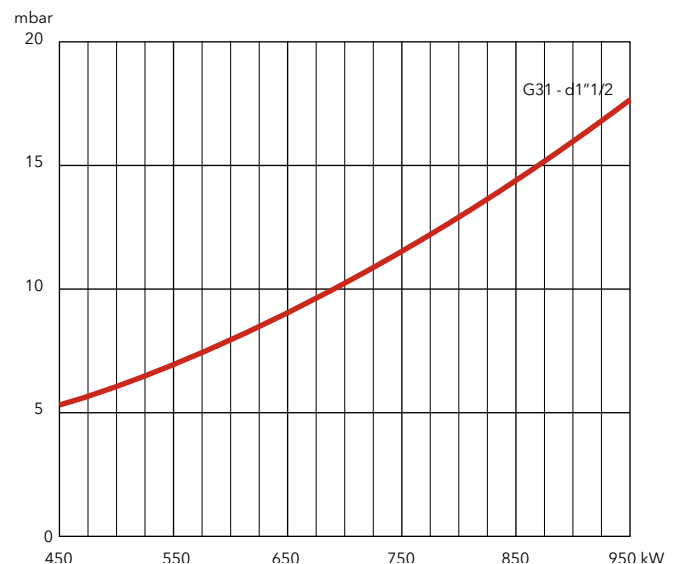



PRESSURE LOSS [BURNER HEAD + GAS TRAIN] (mbar)

VG5.1200 M V

Burner output (kW)	Natural gas G20 Hi = 10,35 kWh/m ³					Natural gas G25 Hi = 8,83 kWh/m ³					LPG G31
	d3/4-Rp1"1/4	d1"1/2-Rp2"	d2"-Rp2"	d65-DN65	s65-DN65	d3/4-Rp1"1/4	d1"1/2-Rp2"	d2"-Rp2"	d65-DN65	s65-DN65	d1"1/2-Rp2"
700	40	16	12	10	10	60	21	14	10	12	10
800	53	20	14	13	13	79	27	17	13	15	12
900	68	25	17	16	16	100	34	21	16	19	15
1000	84	31	21	20	20	126	42	26	20	24	18
1100	103	37	25	24	24	154	50	31	24	29	22
1200	123	44	29	29	29	186	59	36	29	34	26

Natural gas G20

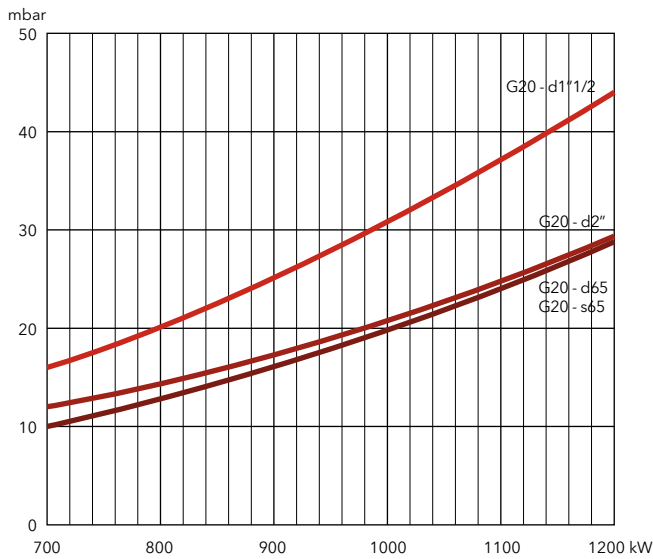

Natural gas G25

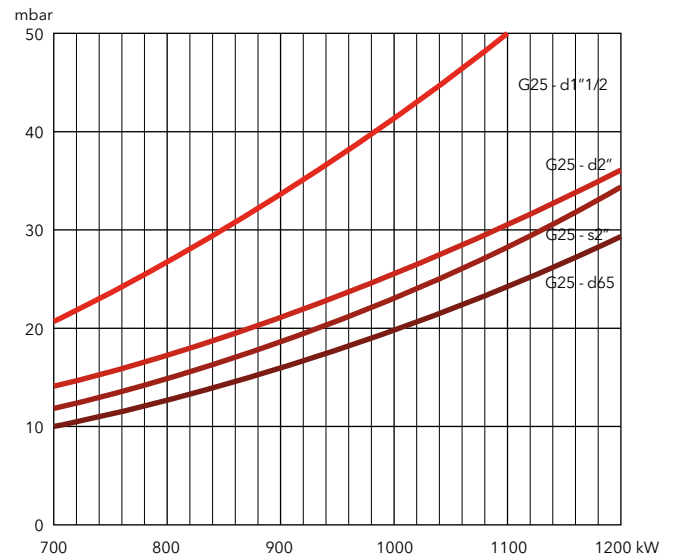

Natural gas G20, G25

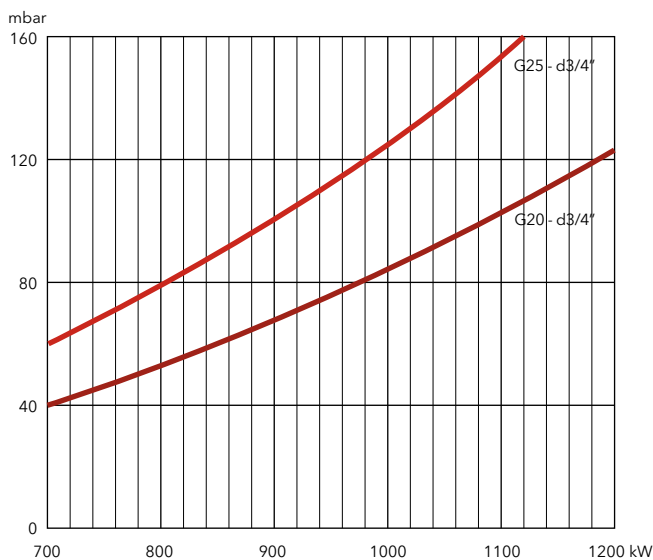

LPG

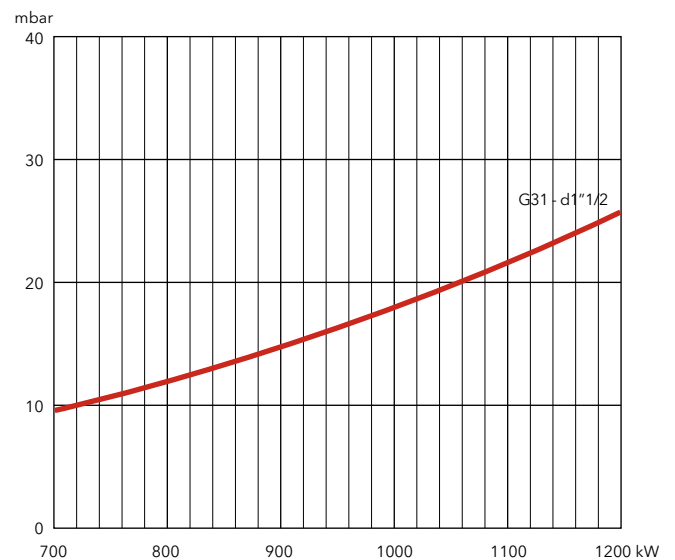

VG6.1600 M V / VG6.2100 M V

240 ... 1900 kW

Two stage progressive/modulating electronic + fan speed control



- **Fuels:** natural gas (G20/G25, $H_u = 8,83...10,35 \text{ kWh/m}^3$); LPG (G31, $H_u = 25,89 \text{ kWh/m}^3$)
- **Emissions:** $\text{NO}_x < 70 \text{ mg/kWh (NCV)}$, Low NO_x class 3 burners according to EN676
- **Operation:** two stage progressive or modulating with the installation of a power regulator and dedicated probes (see page 218), fan speed control and integrated tightness control
- **Protection level:** IP 21

TECHNICAL DATA

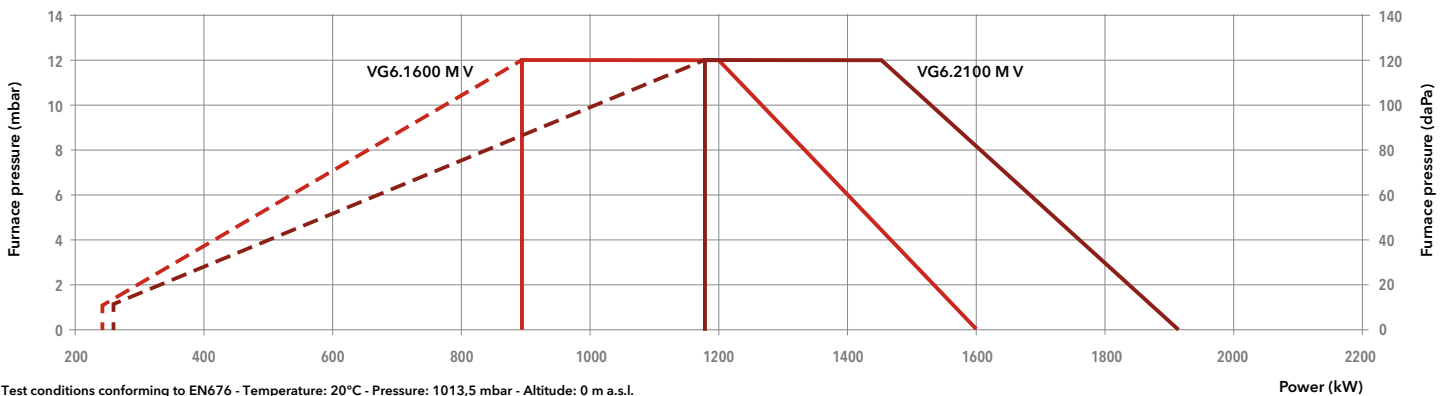

Model	VG6.1600 M V /TC			VG6.2100 M V /TC			
Operation range	(240) 890 - 1600 kW			(260) 1180 - 1900 kW			
Gas pressure	20 - 300 mbar			20 - 300 mbar			
Control box / flame detection	BT3... / IRD 1020.1			BT3... / IRD 1020.1			
Fan motor	230/400 V - 50 Hz - 2,2 kW			230/400 V - 50 Hz - 2,5 kW			
Electrical consumption	55 + 2600 W			55 + 3400 W			
Acoustic level (LpA)	77,2 dB(A)			79 dB(A)			
CE certificate	0085 CN 0192			0085 CN 0192			
Head length	KN	KL	KM	KN	KL	KM	
Complete	VGD 40-065 s65-DN65/TC	3835265	3835273	3835281	3835269	3835277	3835285
burner code	MBC1900 d65-DN65/TC	3835266	3835274	3835282	3835270	3835278	3835286
	MBC1200 d2"-Rp2"/TC	3835267	3835275	3835283	3835271	3835279	3835287
	MBC700 d1"1/2-Rp2"/TC	3835268	3835276	3835284	3835272	3835280	3835288

OTHER AVAILABLE VERSIONS

- Vent** Versions for continuous ventilation and post-ventilation
- PED** PED version for continuous operation

SCOPE OF SUPPLY

The burner is delivered in its package complete with:

- 1 burner head with flange seal and securing screws
- 1 compact gas train with gas filter; the gas filter is built-in for threaded valves (up to 2") and separated for flanged ones (DN65/80/100)
- 1 bag containing installation fittings
- 1 bag containing technical documentation (instruction manual, technical data, electrical diagram, exploded view and spare parts list)



DIMENSIONS (mm)

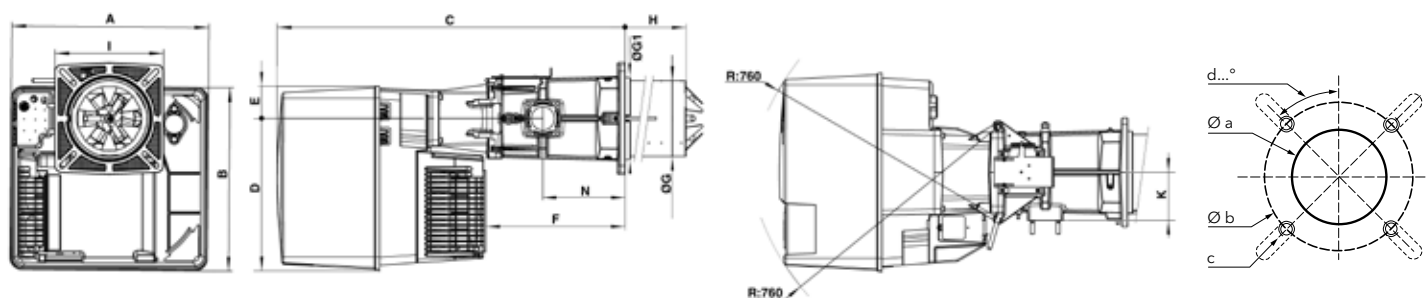

A	B	C	D	E	F	ØG	ØG1	H			I	K	N
								KN	KM	KL			
592	553	1050	456	97	421	227	245	310	410	510	326x335	144	247

Øa (mm)	b (mm)	c	d
250	300-400	M12	45°

Gas trains

Gas train "d":

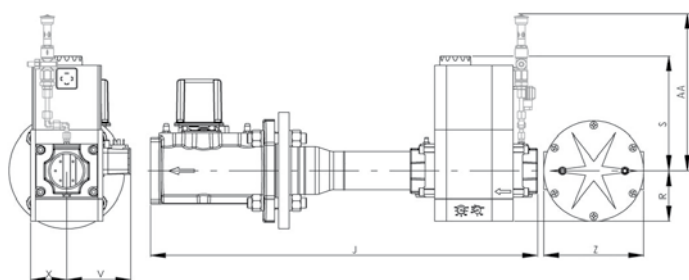

Model	J	R	S	V	X	Z	AA*
d65-DN65	490	183	245	110	98	290	385
d2"-Rp2"	700	96	330	125	81	-	385
d1"1/2-Rp2"	622	80	185	102	57	-	320

Gas train "s":

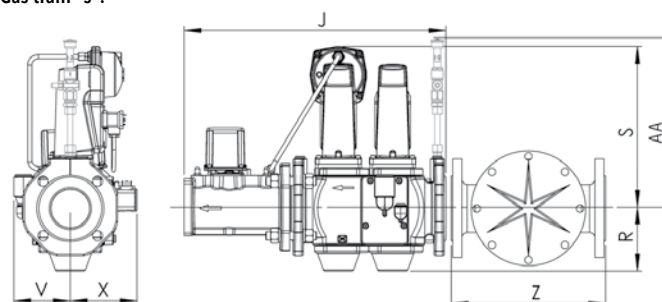

Model	J	R	S	V	X	Z	AA*
s65-DN65	490	118	300	106	126	290	365

*: for PED configuration

PACKAGING

The burner is delivered on a pallet in three packages containing:

- burner housing
- combustion head
- gas train and filter

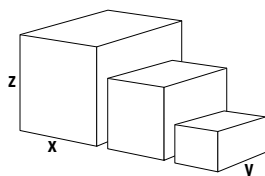

Component		Dimensions (mm)			Gross weight (kg)
		X	Y	Z	
Burner body	VG6.1600 M V	800	600	850	56
	VG6.2100 M V	800	600	850	56
Combustion head	KN	1000	380	420	26,7
	KL	1100	380	430	29,4
	KM	1100	380	430	28
Gas train	s65-DN65/TC	670	550	380	29,4
	d65-DN65/TC	670	550	380	33
	d2"-Rp2"/TC	670	550	380	22
	d1"1/2-Rp2"/TC	670	550	380	21

VG6.1600 M V / VG6.2100 M V

240 ... 1900 kW

Two stage progressive/modulating electronic + fan speed control

PRESSURE LOSS [BURNER HEAD + GAS TRAIN] (mbar)

VG6.1600 M V

Burner output (kW)	Natural gas G20 Hi = 10,35 kWh/m ³				Natural gas G25 Hi = 8,83 kWh/m ³				LPG G31 Hi = 25,89 kWh/m ³
	d1"1/2-Rp2"	d2"-Rp2"	d65-DN65	s65-DN65	d1"1/2-Rp2"	d2"-Rp2"	d65-DN65	s65-DN65	d1"1/2-Rp2"
800	16	9	6	6	22	12	8	8	8
1000	25	13	10	9	34	18	12	12	12
1200	35	18	14	13	48	24	18	18	17
1400	47	24	19	18	64	32	24	24	22
1600	61	31	25	23	83	42	31	31	29

Natural gas G20

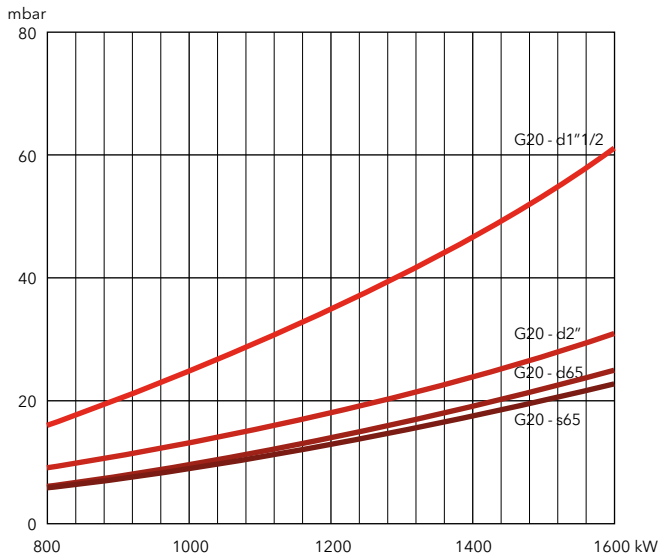

Natural gas G25

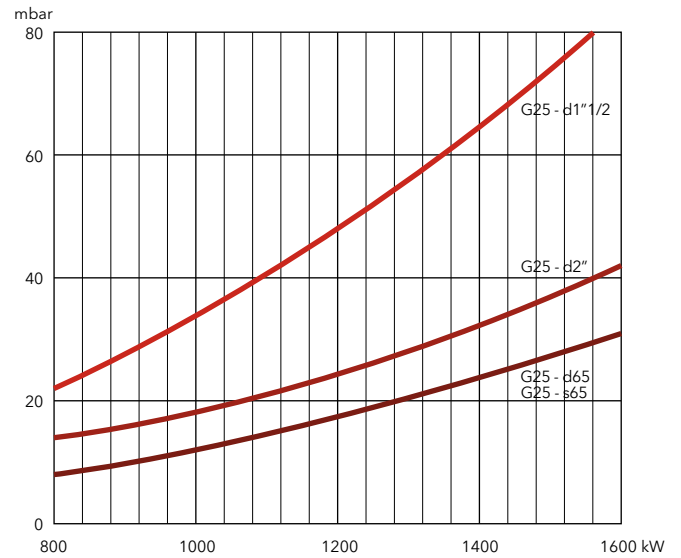

LPG

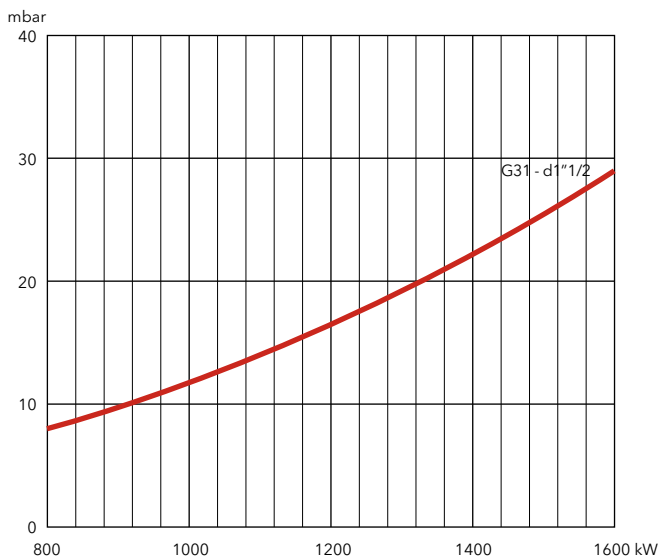



PRESSURE LOSS [BURNER HEAD + GAS TRAIN] (mbar)

VG6.2100 M V

Burner output (kW)	Natural gas G20 Hi = 10,35 kWh/m ³				Natural gas G25 Hi = 8,83 kWh/m ³				LPG G31 Hi = 25,89 kWh/m ³	
	d1"1/2-Rp2"	d2"-Rp2"	d65-DN65	s65-DN65	d1"1/2-Rp2"	d2"-Rp2"	d65-DN65	s65-DN65	d1"1/2-Rp2"	d2"-Rp2"
1100	28	15	12	11	39	21	15	15	13	9
1300	39	21	16	16	54	29	21	22	18	11
1500	51	27	21	21	71	37	28	29	23	14
1700	64	34	27	27	91	47	36	37	29	17
1900	80	41	34	34	114	59	45	46	36	20

Natural gas G20

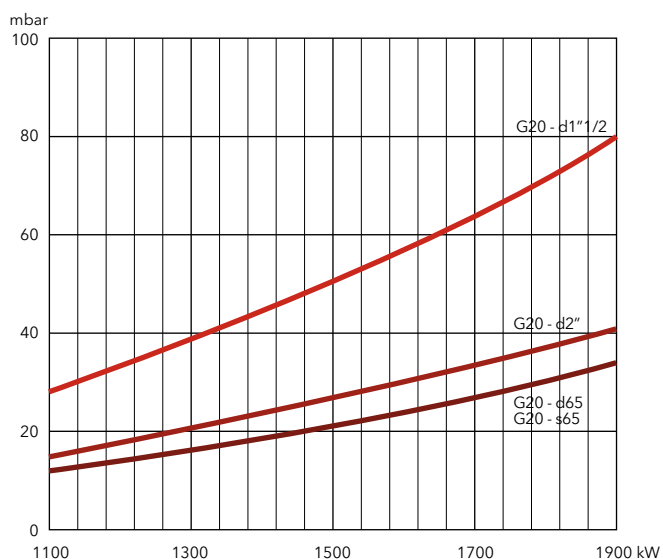

Natural gas G25

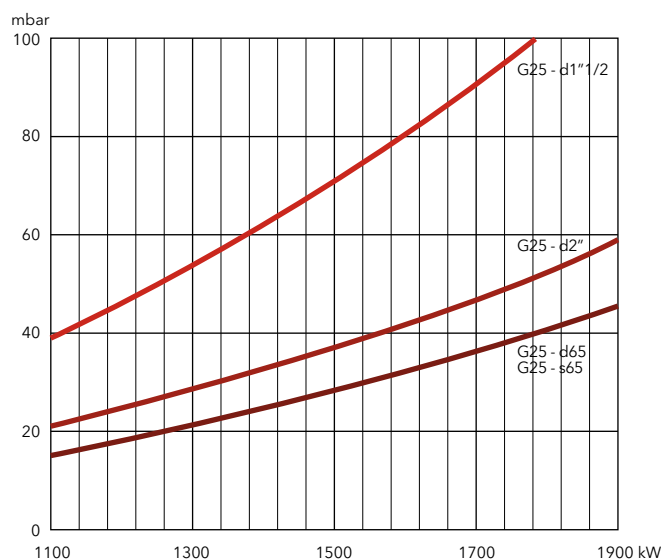

LPG

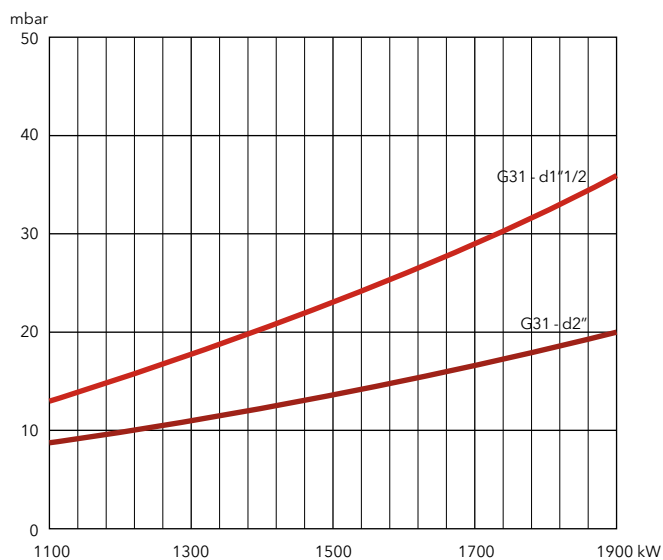

VG5.950 DP R / VG5.1200 DP R

150 ... 1200 kW
2 stage progressive/modulating pneumatic

- **Fuels:** natural gas (G20/G25, $H_u = 8,83...10,35 \text{ kWh/m}^3$); LPG (G31, $H_u = 25,89 \text{ kWh/m}^3$)
- **Emissions:** $\text{NO}_x < 120 \text{ mg/kWh}$ (NCV), Low NO_x class 2 burners according to EN676
- **Operation:** two stage progressive or modulating with the installation of a power regulator and dedicated probes (see page 218)
- **Protection level:** IP 21



TECHNICAL DATA

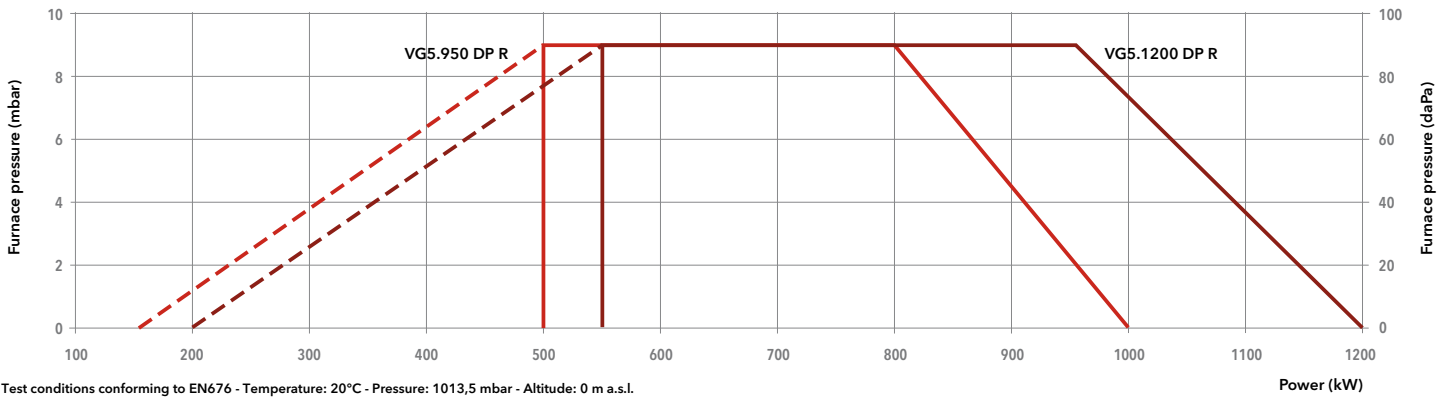

Model	VG5.950 DP R			VG5.1200 DP R		
Operation range	(150) 500 - 1000 kW			(200) 550 - 1200 kW		
Gas pressure	20 - 500 mbar			20 - 500 mbar		
Control box / flame detection	TCG 5.. / ionization			TCG 5.. / ionization		
Fan motor	230/400 V - 50 Hz - 1,5 kW			230/400 V - 50 Hz - 1,5 kW		
Electrical consumption	100 + 2200 W			100 + 2300 W		
Acoustic level (LpA)	77 dB(A)			77 dB(A)		
CE certificate	0085 CQ 0570			0085 CQ 0570		
Head length	KN	KL	KM	KN	KL	KM
Complete burner code	VGD 40-065 s65-DN65	-	-	3835377	3835378	3835379
	VGD 20-5011 s2"-Rp2"	3835357	3835366	3835380	3835381	3835382
	MB-VEF 420 d1"1/2-Rp2"	3835368	3835369	3835370	3835383	3835385
	MB-VEF 412 d1"1/4-Rp2"	3835371	3835372	3835373	3835386	3835387
	MB-VEF 407 d3/4"-Rp1"	3835374	3835375	3835376	-	-

OTHER AVAILABLE VERSIONS

- 60 60 Hz version
- TC Version with tightness control
- V_{vent} Versions for continuous ventilation and post-ventilation

SCOPE OF SUPPLY

The burner is delivered in its package complete with:

- 1 burner head with flange seal and securing screws
- 1 compact gas train with gas filter; the gas filter is built-in for threaded valves (up to 2") and separated for flanged ones (DN65/80/100)
- 1 bag containing installation fittings
- 1 bag containing technical documentation (instruction manual, technical data, electrical diagram, exploded view and spare parts list)

DIMENSIONS (mm)

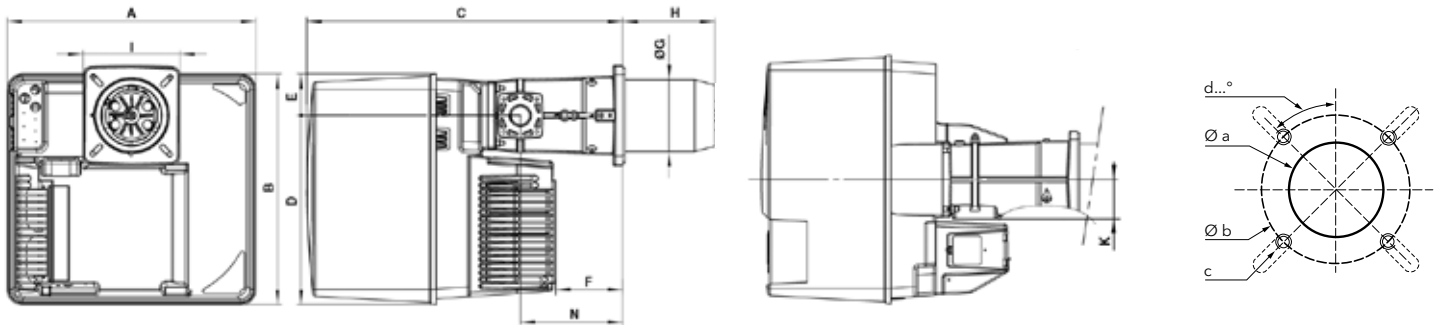

A	B	C	D	E	F	ØG	H			I	K	N
							KN	KM	KL			
581	549	752	450	99	164	170	215	325	435	230x238	89	244

Øa (mm)	b (mm)	c	d
195	220-260	M10	45°

Gas trains

Gas train "d":

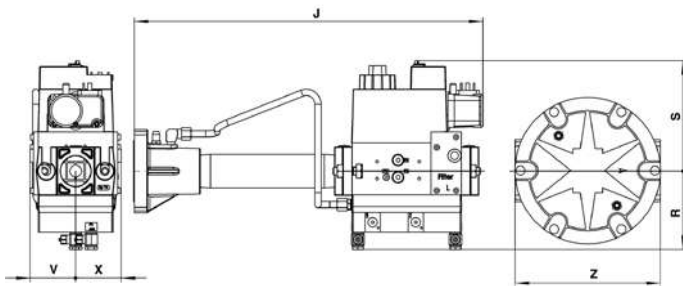

Model	J	R	S	V	X	Z
d1"1/2-Rp2"	540	123	190	55	55	-
d1"1/4-Rp2"	450	100	141	58	58	186
d3/4"-Rp1"	420	100	122	55	50	160

Gas train "s":

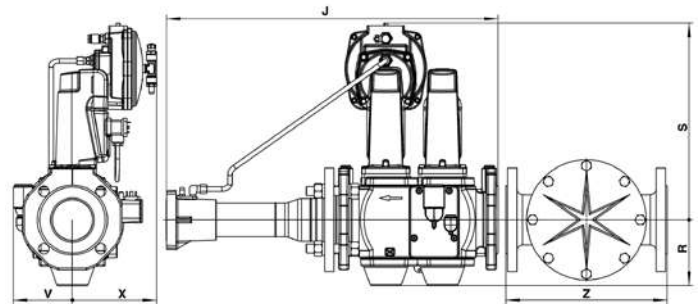

Model	J	R	S	V	X	Z
s65-DN65	600	135	360	110	150	290
s2"-Rp2"	612	103	330	110	150	186

PACKAGING

The burner is delivered on a pallet in three packages containing:

- burner housing
- combustion head
- gas train and filter

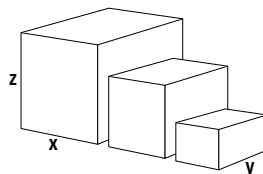

Component		Dimensions (mm)			Gross weight (kg)
		X	Y	Z	
Burner body	VG5.950 DP R	800	600	850	55
	VG5.1200 DP R	800	600	850	56
Combustion head	KN	780	265	280	12,3
	KL	1010	265	280	14,4
	KM	1010	265	280	13,4
Gas train	s65-DN65	670	530	380	29
	s2"-Rp2"	670	530	380	17,2
	d1"1/2-Rp2"	400	570	200	12
	d1"1/4-Rp2"	590	390	180	12
	d3/4"-Rp1"	590	390	180	7

VG5.950 DP R / VG5.1200 DP R

150 ... 1200 kW

2 stage progressive/modulating pneumatic

PRESSURE LOSS [BURNER HEAD + GAS TRAIN] (mbar)

VG5.950 DP R

Burner output (kW)	Natural gas G20 Hi = 10,35 kWh/m ³				Natural gas G25 Hi = 8,83 kWh/m ³				LPG G31 Hi = 25,89 kWh/m ³			
	d3/4"-Rp1"	d1"1/4-Rp2"	d1"1/2-Rp2"	s2"-Rp2"	d3/4"-Rp1"	d1"1/4-Rp2"	d1"1/2-Rp2"	s2"-Rp2"	d3/4"-Rp1"	d1"1/4-Rp2"	d1"1/2-Rp2"	s2"-Rp2"
500	87	18	11	7	129	26	15	11	40	11	8	7
600	120	24	14	10	179	36	21	15	55	15	11	9
700	167	34	20	14	248	51	30	21	77	21	15	13
800	214	43	25	18	-	65	38	27	98	27	19	16
900	-	56	33	23	-	83	48	34	126	35	25	21
1000	-	68	40	28	-	101	59	42	153	42	30	26

Natural gas G20

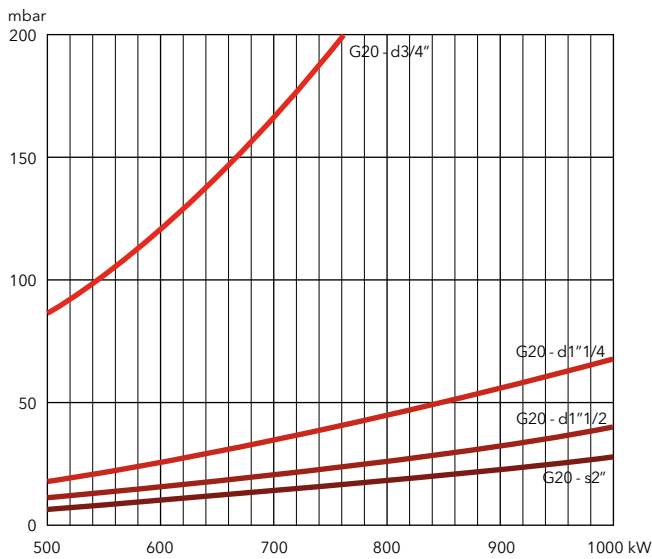

Natural gas G25

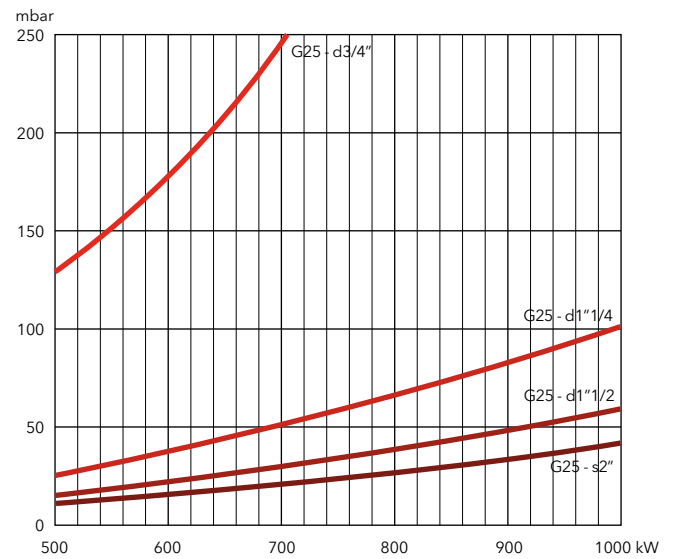

LPG

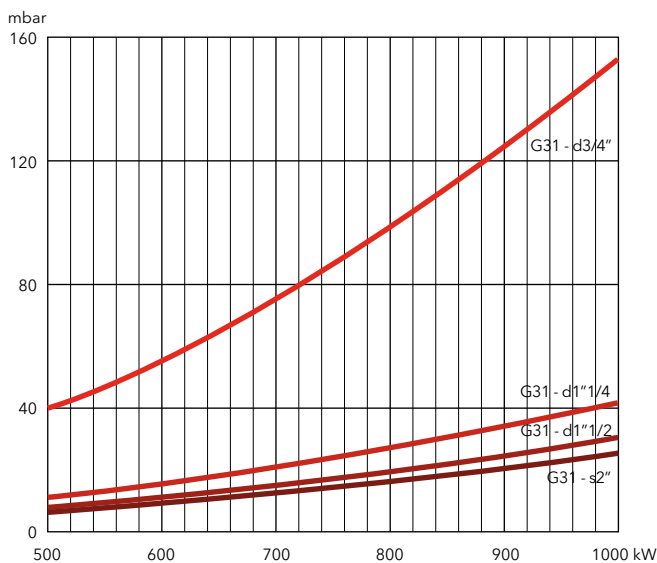



PRESSURE LOSS [BURNER HEAD + GAS TRAIN] (mbar)

VG5.1200 DP R

Burner output (kW)	Natural gas G20 Hi = 10,35 kWh/m ³				Natural gas G25 Hi = 8,83 kWh/m ³				LPG G31 Hi = 25,89 kWh/m ³		
	d1"1/4-Rp2"	d1"1/2-Rp2"	s2"-Rp2"	s65-Rp2"	d1"1/4-Rp2"	d1"1/2-Rp2"	s2"-Rp2"	s65-Rp2"	d1"1/4-Rp2"	d1"1/2-Rp2"	s2"-Rp2"
700	30	16	10	8	45	24	16	12	16	10	8
800	39	21	14	10	58	32	20	16	21	13	10
900	50	27	18	13	74	40	26	20	26	17	13
1000	61	33	21	16	91	49	32	25	33	21	16
1100	74	40	26	20	110	60	39	30	40	26	19
1200	88	48	31	24	132	71	46	35	47	30	23

Natural gas G20

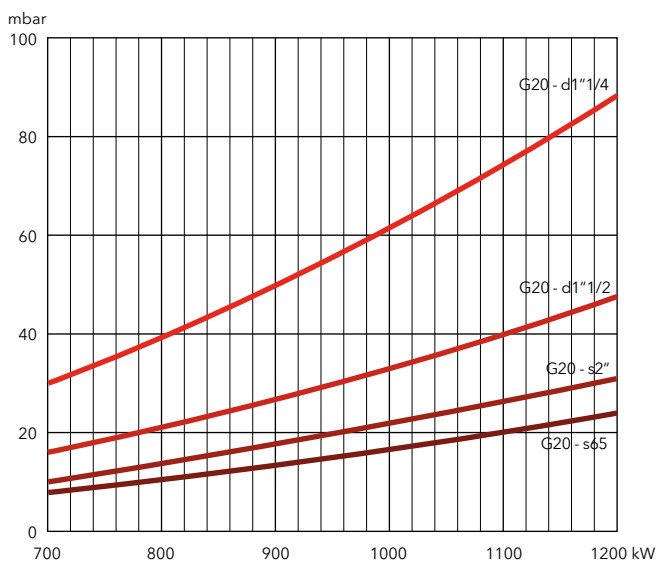

Natural gas G25

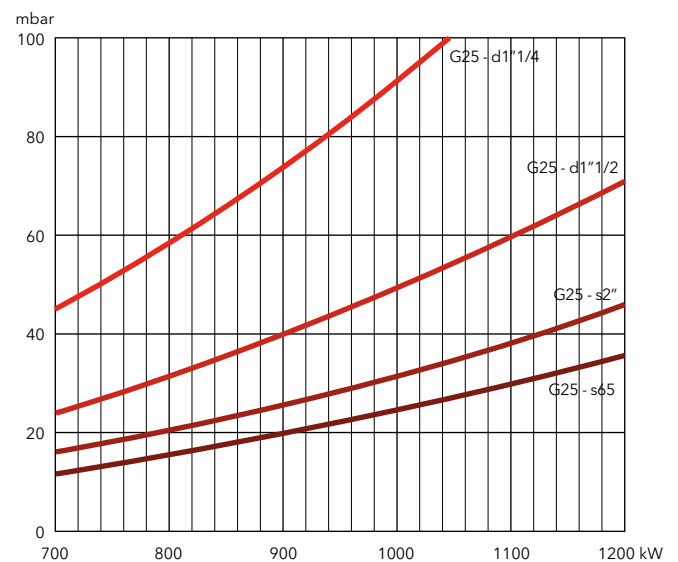

LPG

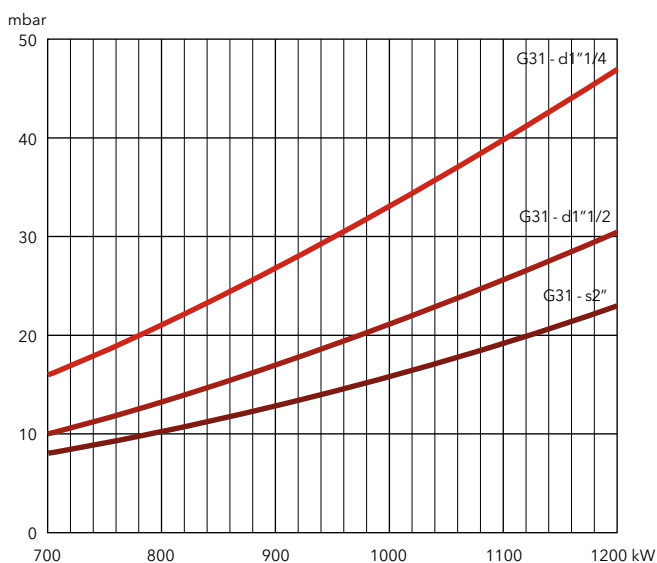

VG6.1600 DP R / VG6.2100 DP R

200 ... 2300 kW
2 stage progressive/modulating pneumatic



- **Fuels:** natural gas (G20/G25, $H_u = 8,83...10,35 \text{ kWh/m}^3$); LPG (G31, $H_u = 25,89 \text{ kWh/m}^3$)
- **Emissions:** NOx < 120 mg/kWh (NCV), Low NOx class 2 burners according to EN676
- **Operation:** two stage progressive or modulating with the installation of a power regulator and dedicated probes (see page 218)
- **Protection level:** IP 21

TECHNICAL DATA

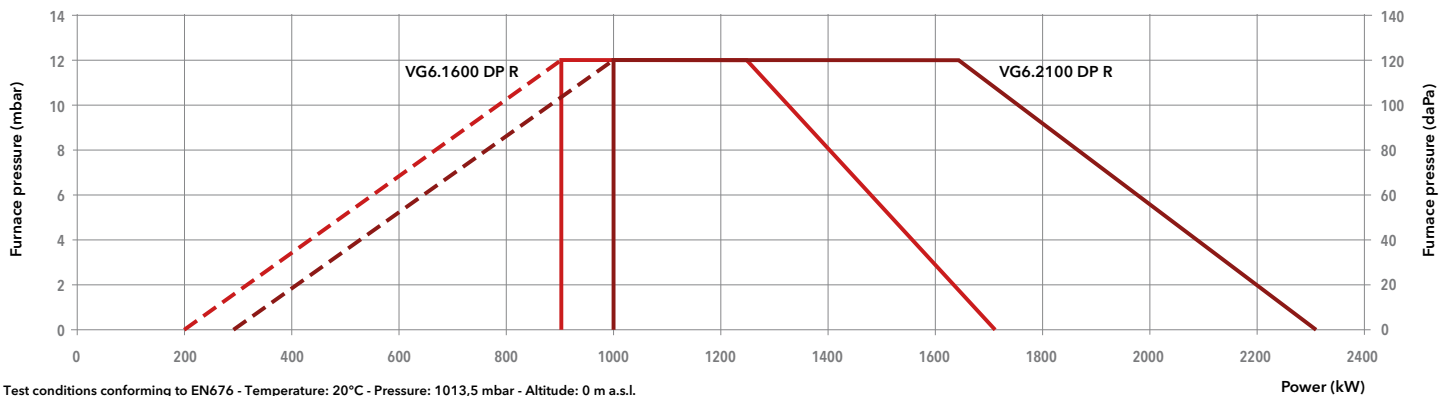

Test conditions conforming to EN676 - Temperature: 20°C - Pressure: 1013,5 mbar - Altitude: 0 m a.s.l.

Model	VG6.1600 DP R /TC			VG6.2100 DP R /TC			
Operation range	(200) 900 - 1700 kW			(300) 1000- 2300 kW			
Gas pressure	20 - 500 mbar			20 - 500 mbar			
Control box / flame detection	TCG 5.. / IRD 1020.1			TCG 5.. / IRD 1020.1			
Fan motor	230/400 V - 50 Hz - 2,2 kW			230/400 V - 50 Hz - 2,5 kW			
Electrical consumption	100 + 2500 W			100 + 3500 W			
Acoustic level (LpA)	77 dB(A)			79 dB(A)			
CE certificate	0085 CQ 0570			0085 CQ 0570			
Head length	KN	KL	KM	KN	KL	KM	
Complete burner code	VGD 40-080 s80-DN80/TC	-	-	-	3835911	3835910	3835909
	VGD 40-065 s65-DN65/TC	3834801	3834802	3834803	3834813	3834814	3834815
	VGD 20-5011 s2"-Rp2"/TC	3834804	3834805	3834806	3834816	3834817	3834818
	MB-VEF 420 d1"1/2-Rp2"/TC	3834807	3834808	3834809	3834819	3834820	3834821
	MB-VEF 412 d1"1/4-Rp2"/TC	3834810	3834811	3834812	3834822	3834823	3834824

OTHER AVAILABLE VERSIONS

60 60 Hz version

V_{ent} Versions for continuous ventilation and post-ventilation

SCOPE OF SUPPLY

The burner is delivered in its package complete with:

- 1 burner head with flange seal and securing screws
- 1 compact gas train with gas filter; the gas filter is built-in for threaded valves (up to 2") and separated for flanged ones (DN65/80/100)
- 1 bag containing installation fittings
- 1 bag containing technical documentation (instruction manual, technical data, electrical diagram, exploded view and spare parts list)

DIMENSIONS (mm)

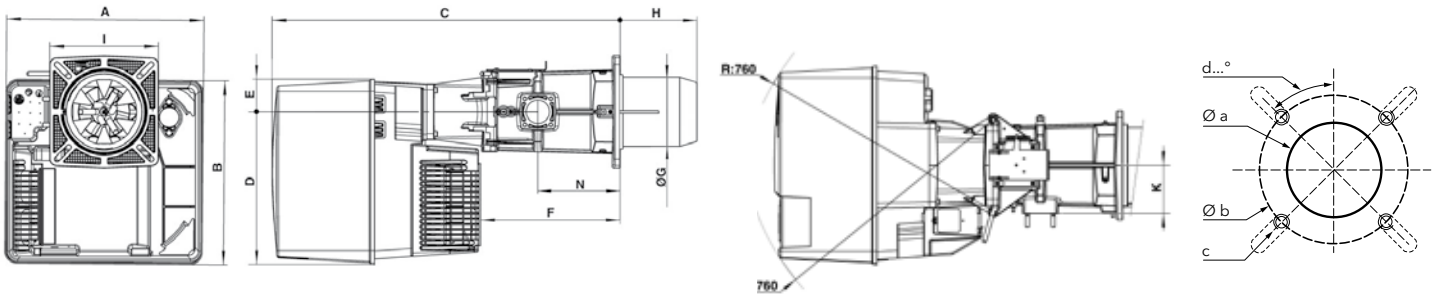

A	B	C	D	E	F	ØG	H			I	K	N
							KN	KM	KL			
592	553	1050	456	97	421	227	270	370	470	326x335	144	247

Øa (mm)	b (mm)	c	d
250	300-400	M12	45°

Gas trains

Gas train "d":

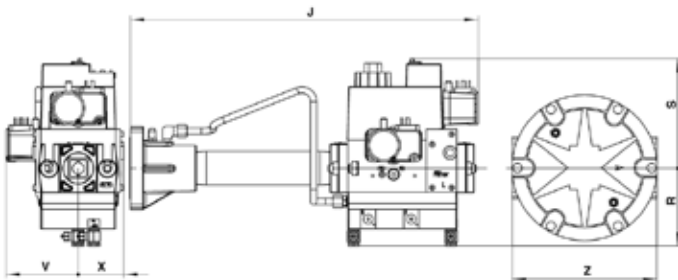

Model	J	R	S	V	X	Z
d1"1/2-Rp2"/TC	540	123	190	95	55	-
d1"1/4-Rp2"/TC	450	100	141	95	58	186

Gas train "s":

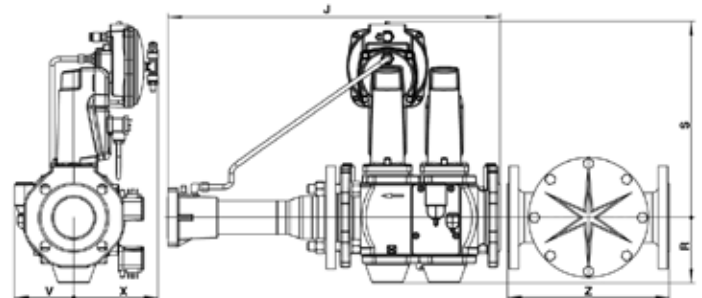

Model	J	R	S	V	X	Z
s80-DN80/TC	600	120	350	110	150	320
s65-DN65/TC	600	135	360	110	150	290
s2"-Rp2"/TC	612	103	330	110	150	186

PACKAGING

The burner is delivered on a pallet in three packages containing:

- burner housing
- combustion head
- gas train and filter

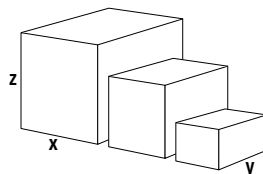

Component		Dimensions (mm)			Gross weight (kg)
		X	Y	Z	
Burner body	VG6.1600 DP R	800	600	850	67,8
	VG6.2100 DP R	800	600	850	69,2
Combustion head	KN	1000	380	420	26,7
	KL	1100	380	430	29,4
	KM	1100	380	430	28
Gas train	s80-DN80/TC	670	530	380	39
	s65-DN65/TC	670	530	380	29,4
	s2"-Rp2"/TC	670	530	380	16,5
	d1"1/2-Rp2"/TC	400	570	200	14,3
	d1"1/4-Rp2"/TC	590	390	180	13

VG6.1600 DP R / VG6.2100 DP R

200 ... 2300 kW

2 stage progressive/modulating pneumatic

PRESSURE LOSS [BURNER HEAD + GAS TRAIN] (mbar)

VG6.1600 DP R

Burner output (kW)	Natural gas G20 Hi = 10,35 kWh/m ³				Natural gas G25 Hi = 8,83 kWh/m ³				LPG G31 Hi = 25,89 kWh/m ³			
	d1"1/4-Rp2"	d1"1/2-Rp2"	s2"-Rp2"	s65-DN65	d1"1/4-Rp2"	d1"1/2-Rp2"	s2"-Rp2"	s65-DN65	d1"1/4-Rp2"	d1"1/2-Rp2"	s2"-Rp2"	s65-DN65
800	34	16	8	5	52	24	12	8	16	8	5	4
1000	52	24	12	8	78	36	18	12	24	12	8	6
1200	76	35	18	11	113	53	27	17	35	18	11	8
1400	103	48	24	15	153	71	37	22	47	24	15	11
1600	135	62	32	20	202	93	48	29	62	32	19	14

Natural gas G20

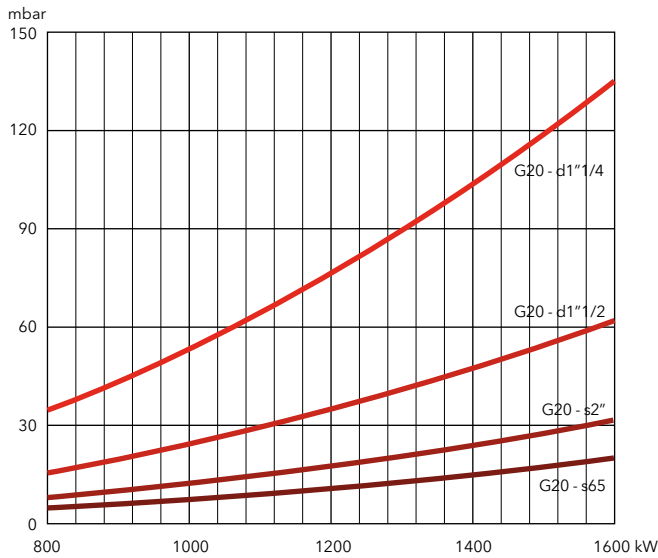

Natural gas G25

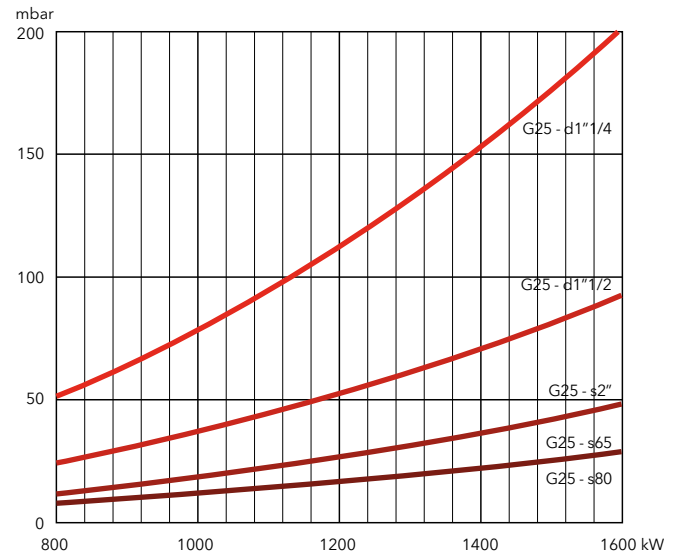

LPG

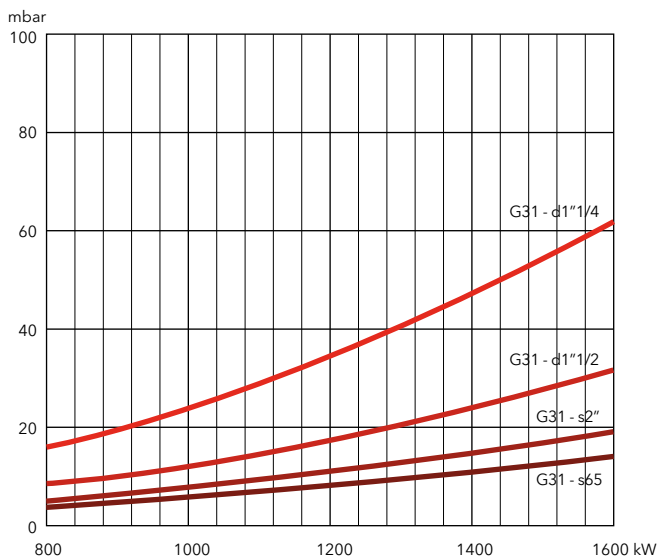



PRESSURE LOSS [BURNER HEAD + GAS TRAIN] (mbar)

VG6.2100 DP R

Burner output (kW)	Natural gas G20 Hi = 10,35 kWh/m ³					Natural gas G25 Hi = 8,83 kWh/m ³					LPG G31 Hi = 25,89 kWh/m ³		
	d1"1/4- Rp2"	d1"1/2- Rp2"	s2"- Rp2"	s65- DN65	s80- DN80	d1"1/4- Rp2"	d1"1/2- Rp2"	s2"- Rp2"	s65- DN65	s80- DN80	d1"1/4- Rp2"	d1"1/2- Rp2"	s2"- Rp2"
1300	87	39	19	10	7	130	58	28	16	10	38	18	10
1500	114	51	25	14	9	170	76	37	21	13	50	24	13
1700	147	66	32	18	11	220	98	48	27	17	65	31	17
1900	184	83	40	22	14	274	123	60	34	21	81	38	21
2100	225	101	49	27	17	336	151	73	41	26	99	47	26
2300	269	121	58	33	21	402	180	87	49	31	119	56	30

Natural gas G20

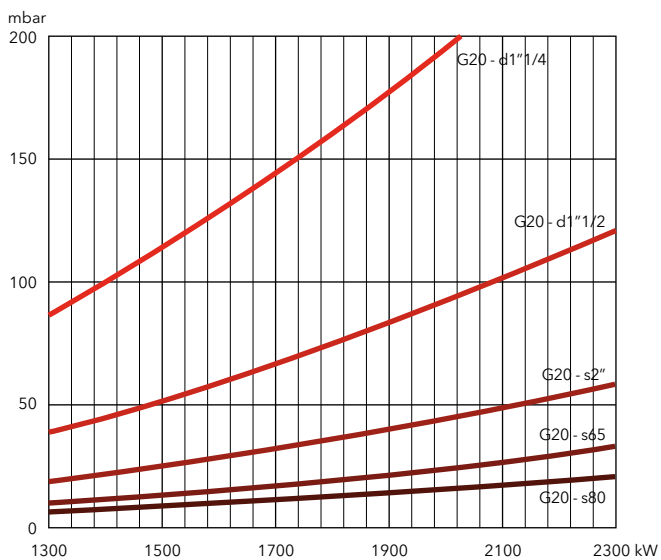

Natural gas G25

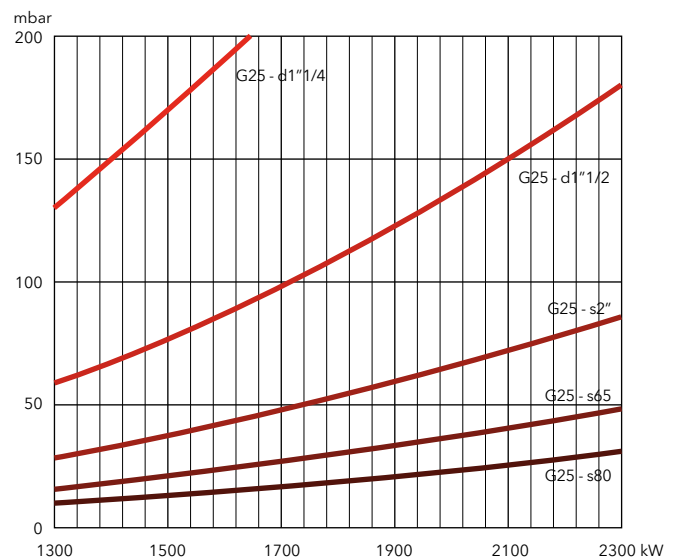

LPG

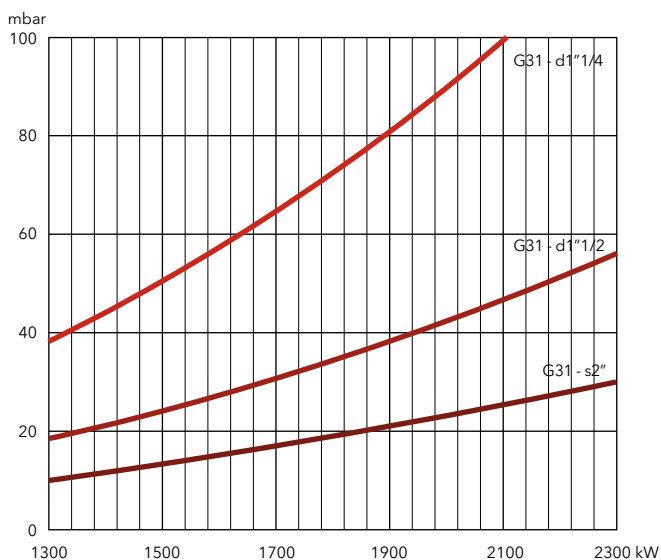

VG5.950 M R / VG5.1200 M R

150 ... 1200 kW

Two stage progressive/modulating electronic

- **Fuels:** natural gas (G20/G25, $H_u = 8,83...10,35 \text{ kWh/m}^3$); LPG (G31, $H_u = 25,89 \text{ kWh/m}^3$)
- **Emissions:** $\text{NO}_x < 120 \text{ mg/kWh}$ (NCV), Low NO_x class 2 burners according to EN676
- **Operation:** two stage progressive or modulating with the installation of a power regulator and dedicated probes (see page 218)
- **Protection level:** IP 21



TECHNICAL DATA

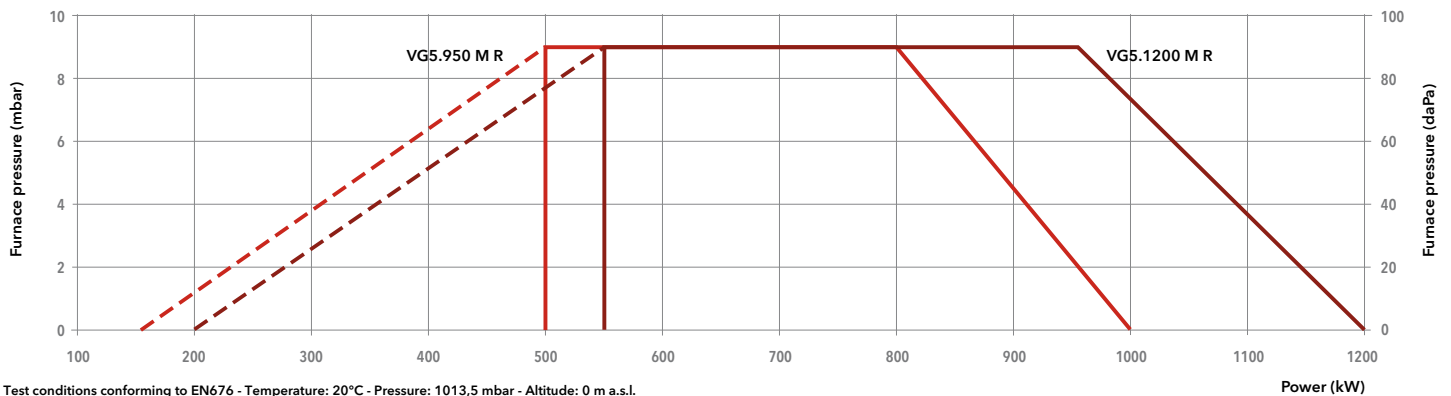

Model	VG5.950 M R /TC			VG5.1200 M R /TC			
Operation range	(150) 500 - 1000 kW			(200) 550 - 1200 kW			
Gas pressure	50 - 500 mbar			50 - 500 mbar			
Control box / flame detection	BT3... / ionization			BT3... / ionization			
Fan motor	230/400 V - 50 Hz - 1,5 kW			230/400 V - 50 Hz - 1,5 kW			
Electrical consumption	100 + 2200 W			100 + 2300 W			
Acoustic level (LpA)	77 dB(A)			77 dB(A)			
CE certificate	0085 CQ 0570			0085 CQ 0570			
Head length		KN	KL	KM	KN	KL	KM
Complete burner code	VGD 40-065 s65-DN65/TC	3835413	3835414	3835415	3835428	3835429	3835430
	MBC1900 d65-DN65/TC	3835416	3835417	3835418	3835431	3835432	3835433
	MBC1200 d2"-Rp2"/TC	3835419	3835420	3835421	3835434	3835435	3835436
	MBC700 d1"1/2-Rp2"/TC	3835422	3835423	3835424	3835437	3835438	3835439
	MBC300 d3/4"-Rp1"1/4/TC	3835425	3835426	3835427	3835440	3835441	3835442

OTHER AVAILABLE VERSIONS

- Vent** Versions for continuous ventilation and post-ventilation
- PED** PED version for continuous operation

SCOPE OF SUPPLY

The burner is delivered in its package complete with:

- 1 burner head with flange seal and securing screws
- 1 compact gas train with gas filter; the gas filter is built-in for threaded valves (up to 2") and separated for flanged ones (DN65/80/100)
- 1 bag containing installation fittings
- 1 bag containing technical documentation (instruction manual, technical data, electrical diagram, exploded view and spare parts list)



DIMENSIONS (mm)

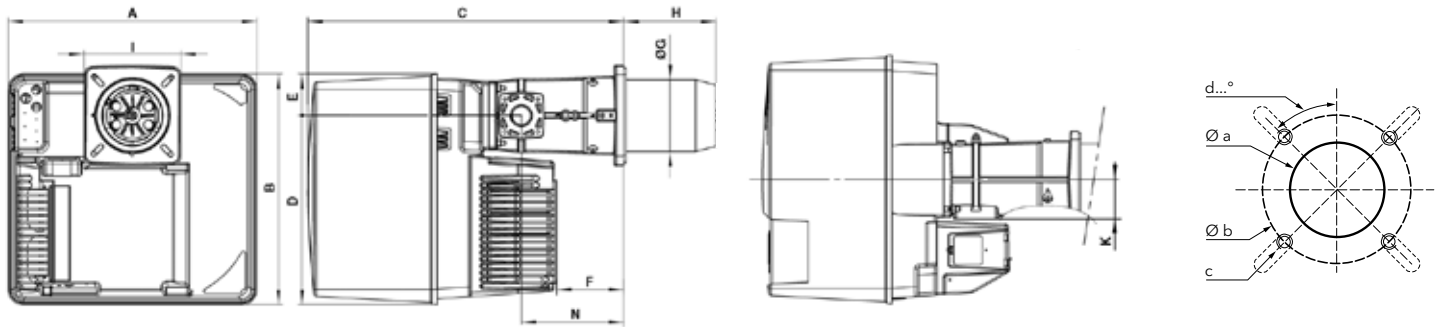

A	B	C	D	E	F	ØG	H			I	K	N
							KN	KM	KL			
581	549	752	450	99	164	170	215	325	435	230x238	89	244

Øa (mm)	b (mm)	c	d
195	220-260	M10	45°

Gas trains

Gas train "d":

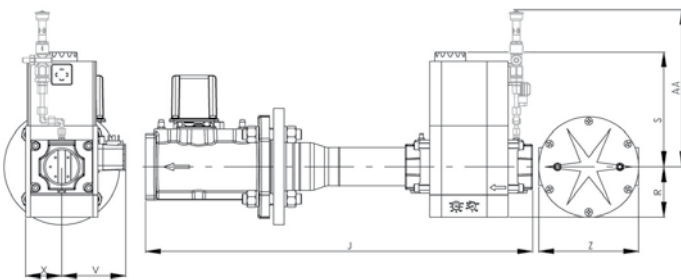

Model	J	R	S	V	X	Z	AA*
d65-DN65	490	183	245	110	98	290	385
d2"-Rp2"	700	96	330	125	81	-	385
d1"1/2-Rp2"	622	80	185	102	57	-	320
d3/4"-Rp1"1/4	460	60	173	88	58	-	320

Gas train "s":

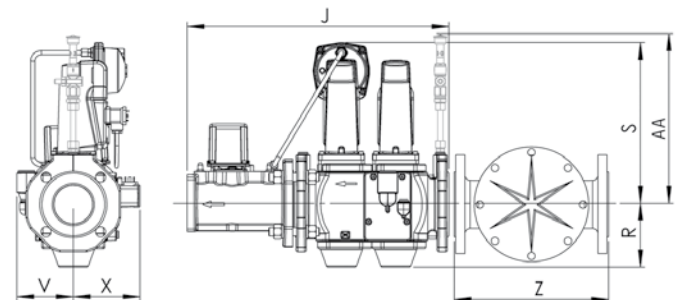

Model	J	R	S	V	X	Z	AA*
s65-DN65	490	118	300	106	126	290	365

*: for PED configuration

PACKAGING

The burner is delivered on a pallet in three packages containing:

- burner housing
- combustion head
- gas train and filter

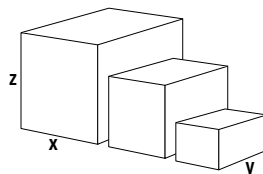

Component		Dimensions (mm)			Gross weight (kg)
		X	Y	Z	
Burner body	VG5.950 M R	800	600	850	53
	VG5.1200 M R	800	600	850	54
Combustion head	KN	780	265	280	12,3
	KL	1010	265	280	14,4
	KM	1010	265	280	13,4
Gas train	s65-DN65/TC	670	550	380	29
	d65-DN65/TC	670	550	380	17,2
	d2"-Rp2"/TC	670	550	380	12
	d1"1/2-Rp2"/TC	670	550	380	12
	d3/4"-Rp1"1/4/TC	590	390	180	7

VG5.950 M R / VG5.1200 M R

150 ... 1200 kW

Two stage progressive/modulating electronic

PRESSURE LOSS [BURNER HEAD + GAS TRAIN] (mbar)

VG5.950 M R

Burner output (kW)	Natural gas G20 Hi = 10,35 kWh/m ³					Natural gas G25 Hi = 8,83 kWh/m ³					LPG G31	
	d3/4-Rp1"1/4	d1"1/2-Rp2"	d2"-Rp2"	d65-DN65	s65-DN65	d3/4-Rp1"1/4	d1"1/2-Rp2"	d2"-Rp2"	d65-DN65	s65-DN65	d1"1/2-Rp2"	d3/4-Rp1"1/4
500	31	10	7	6	6	46	15	11	9	9	17	8
600	45	15	9	9	9	67	22	16	12	13	24	11
700	61	20	13	12	12	91	30	22	17	18	32	15
800	79	26	17	15	15	118	39	28	22	23	42	20
900	124	33	21	19	19	149	49	35	28	29	53	25
1000	-	40	26	24	24	185	60	43	34	36	66	31

Natural gas G20

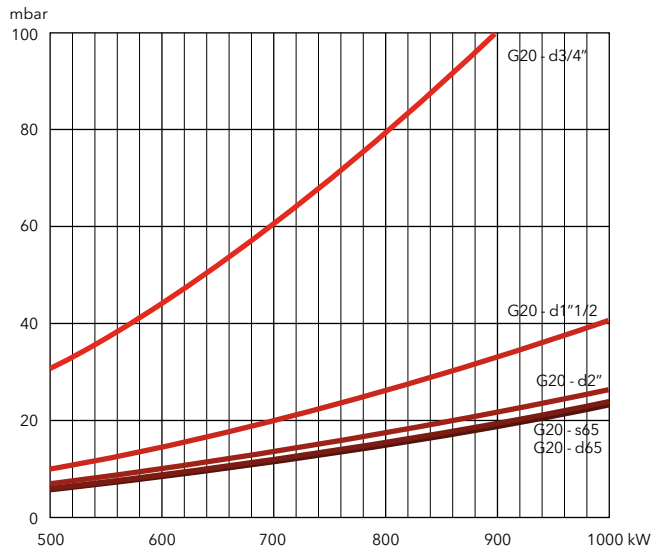

Natural gas G25

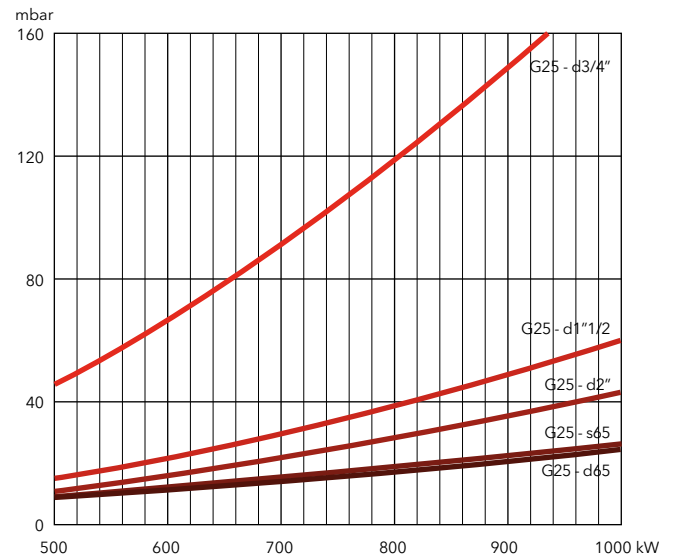

LPG

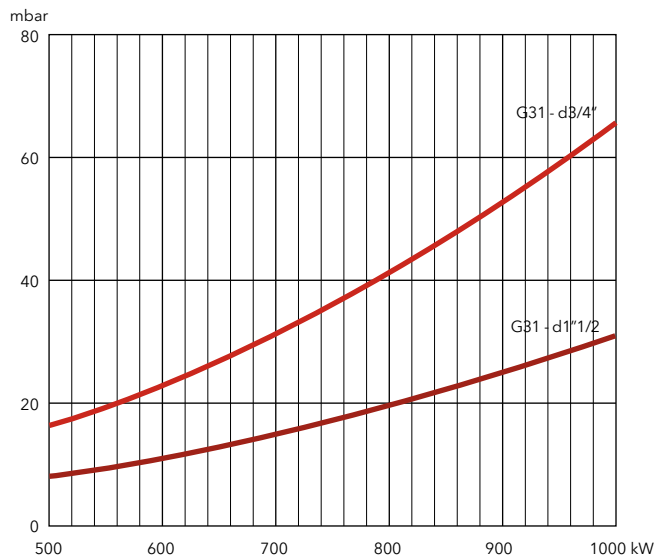



PRESSURE LOSS [BURNER HEAD + GAS TRAIN] (mbar)

VG5.1200 M R

Burner output (kW)	Natural gas G20 Hi = 10,35 kWh/m ³					Natural gas G25 Hi = 8,83 kWh/m ³					LPG G31
	d3/4-Rp1"1/4	d1"1/2-Rp2"	d2"-Rp2"	d65-DN65	s65-DN65	d3/4-Rp1"1/4	d1"1/2-Rp2"	d2"-Rp2"	d65-DN65	s65-DN65	d1"1/2-Rp2"
700	58	17	10	8	9	86	25	14	12	13	10
800	75	22	13	10	11	112	32	19	16	17	14
900	95	27	16	13	14	142	41	24	20	21	17
1000	117	34	20	16	17	175	51	29	24	26	21
1100	142	41	24	20	21	213	62	36	30	32	26
1200	169	49	28	24	25	252	73	42	35	37	31

Natural gas G20

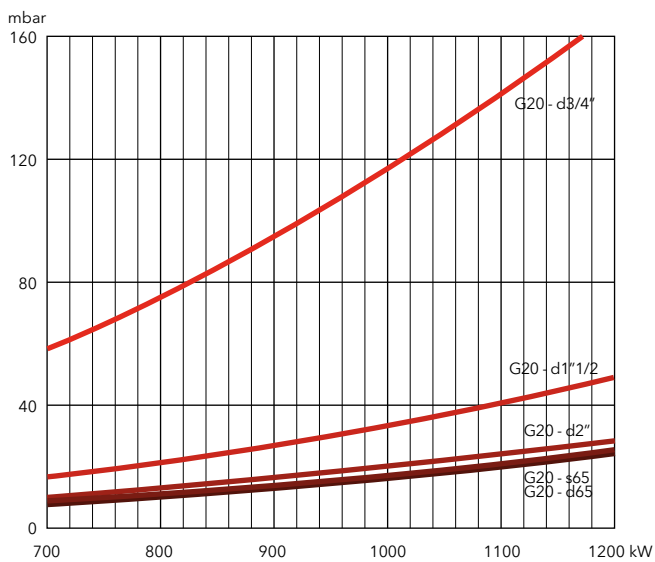

Natural gas G25

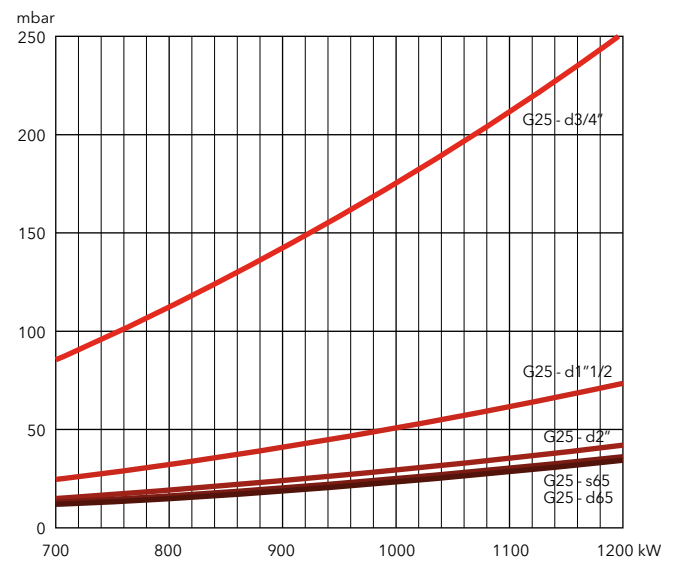

LPG

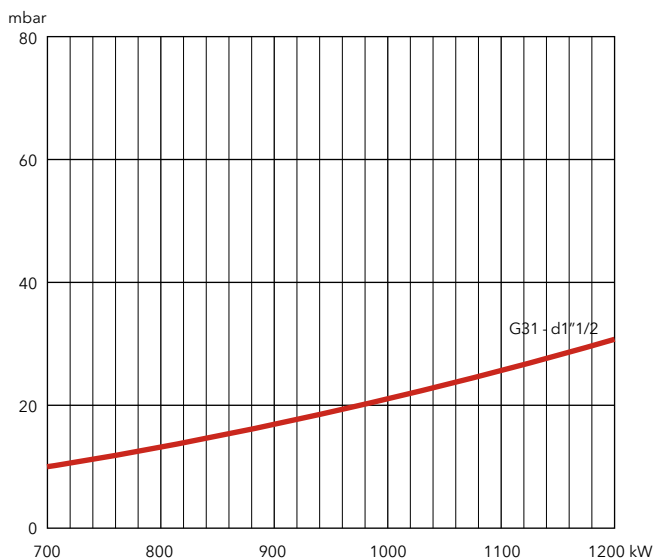

VG6.1600 M R / VG6.2100 M R

200 ... 2300 kW

Two stage progressive/modulating electronic



- **Fuels:** natural gas (G20/G25, $H_u = 8,83...10,35 \text{ kWh/m}^3$); LPG (G31, $H_u = 25,89 \text{ kWh/m}^3$)
- **Emissions:** $\text{NO}_x < 120 \text{ mg/kWh}$ (NCV), Low NO_x class 2 burners according to EN676
- **Operation:** two stage progressive or modulating with the installation of a power regulator and dedicated probes (see page 218)
- **Protection level:** IP 21

TECHNICAL DATA

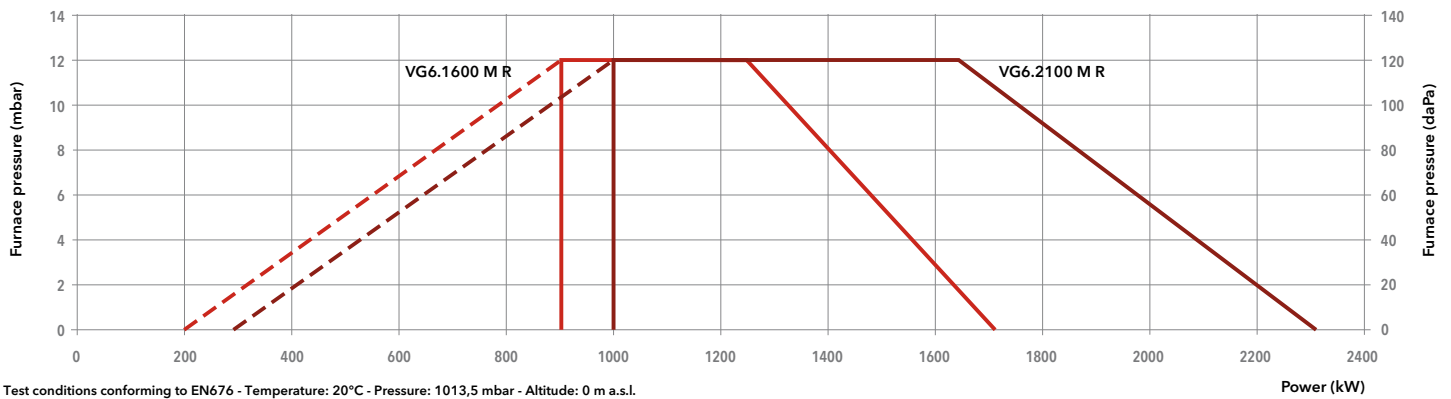

Model	VG6.1600 M R /TC			VG6.2100 M R /TC			
Operation range	(200) 900 - 1700 kW			(300) 1000- 2300 kW			
Gas pressure	50 - 500 mbar			50 - 500 mbar			
Control box / flame detection	BT3... / IRD 1020.1			BT3... / IRD 1020.1			
Fan motor	230/400 V - 50 Hz - 2,2 kW			230/400 V - 50 Hz - 2,5 kW			
Electrical consumption	100 + 2500 W			100 + 3500 W			
Acoustic level (LpA)	77 dB(A)			79 dB(A)			
CE certificate	0085 CQ 0570			0085 CQ 0570			
Head length	KN	KL	KM	KN	KL	KM	
Complete	VGD 40-065 s65-DN65/TC	3834834	3834835	3834836	3834846	3834847	3834848
burner code	MBC1900 d65-DN65/TC	3834831	3834832	3834833	3834843	3834844	3834845
	MBC1200 d2"-Rp2"/TC	3834828	3834829	3834830	3834840	3834841	3834842
	MBC700 d1"1/2-Rp2"/TC	3834825	3834826	3834827	3834837	3834838	3834839

OTHER AVAILABLE VERSIONS

- Vent** Versions for continuous ventilation and post-ventilation
- PED** PED version for continuous operation

SCOPE OF SUPPLY

The burner is delivered in its package complete with:

- 1 burner head with flange seal and securing screws
- 1 compact gas train with gas filter; the gas filter is built-in for threaded valves (up to 2") and separated for flanged ones (DN65/80/100)
- 1 bag containing installation fittings
- 1 bag containing technical documentation (instruction manual, technical data, electrical diagram, exploded view and spare parts list)



DIMENSIONS (mm)

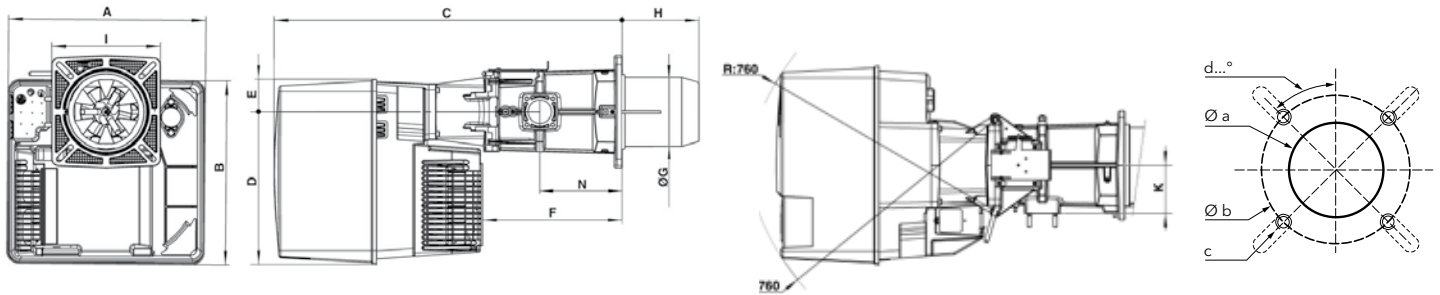

A	B	C	D	E	F	ØG	H			I	K	N
							KN	KM	KL			
592	553	1050	456	97	421	227	270	370	470	326x335	144	247

Øa (mm)	b (mm)	c	d
250	300-400	M12	45°

Gas trains

Gas train "d":

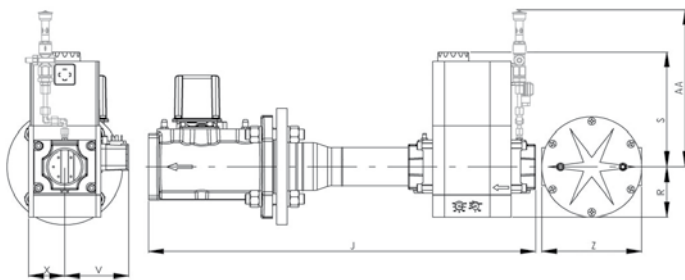

Model	J	R	S	V	X	Z	AA*
d65-DN65	490	183	245	110	98	290	385
d2"-Rp2"	700	96	330	125	81	-	385
d1"1/2-Rp2"	622	80	185	102	57	-	320

Gas train "s":

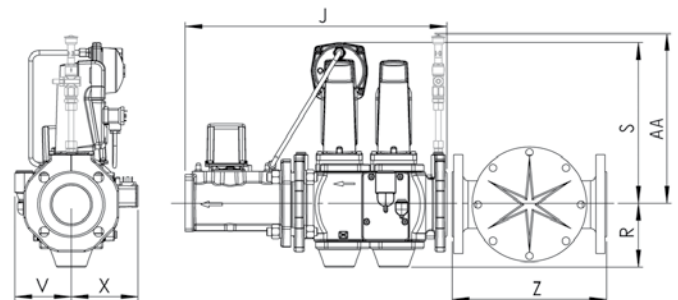

Model	J	R	S	V	X	Z	AA*
s65-DN65	490	118	300	106	126	290	365

*: for PED configuration

PACKAGING

The burner is delivered on a pallet in three packages containing:

- burner housing
- combustion head
- gas train and filter

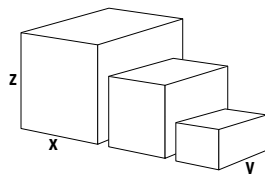

Component		Dimensions (mm)			Gross weight (kg)
		X	Y	Z	
Burner body	VG6.1600 M R	800	600	850	67,8
	VG6.2100 M R	800	600	850	69,2
Combustion head	KN	1000	380	420	26,7
	KL	1100	380	430	29,4
	KM	1100	380	430	28
Gas train	s65-DN65/TC	670	550	380	29,4
	d65-DN65/TC	670	550	380	33
	d2"-Rp2"/TC	670	550	380	16,5
	d1"1/2-Rp2"/TC	670	550	380	14,3

VG6.1600 M R / VG6.2100 M R

200 ... 2300 kW

Two stage progressive/modulating electronic

PRESSURE LOSS [BURNER HEAD + GAS TRAIN] (mbar)

VG6.1600 M R

Burner output (kW)	Natural gas G20 Hi = 10,35 kWh/m ³				Natural gas G25 Hi = 8,83 kWh/m ³				LPG G31
	d1"1/2-Rp2"	d2"-Rp2"	d65-DN65	s65-DN65	d1"1/2-Rp2"	d2"-Rp2"	d65-DN65	s65-DN65	d1"1/2-Rp2"
800	17	7	5	6	25	10	8	9	5
1000	25	11	8	9	37	16	11	13	7
1200	36	16	11	13	54	23	16	19	10
1400	49	21	15	17	73	32	22	25	13
1600	64	28	19	22	96	41	29	33	17

Natural gas G20

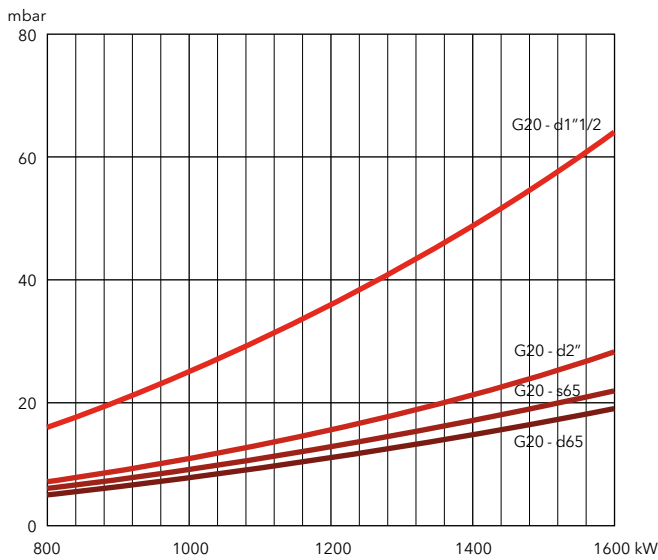

Natural gas G25

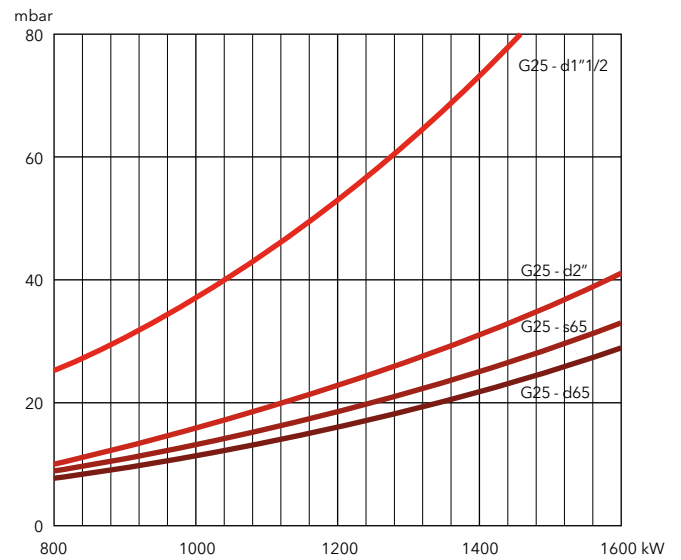

LPG

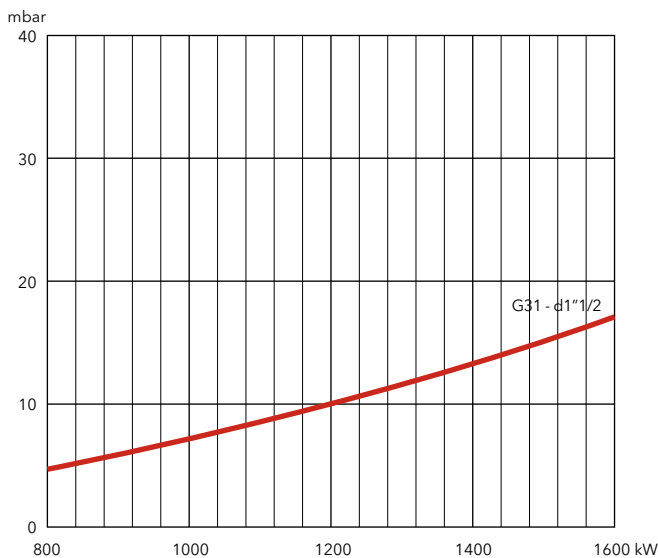



PRESSURE LOSS [BURNER HEAD + GAS TRAIN] (mbar)

VG6.2100 M R

Burner output (kW)	Natural gas G20 Hi = 10,35 kWh/m ³				Natural gas G25 Hi = 8,83 kWh/m ³				LPG G31 Hi = 25,89 kWh/m ³	
	d1"1/2-Rp2"	d2"-Rp2"	d65-DN65	s65-DN65	d1"1/2-Rp2"	d2"-Rp2"	d65-DN65	s65-DN65	d1"1/2-Rp2"	d2"-Rp2"
1300	40	16	10	12	60	24	15	18	19	9
1500	53	21	13	16	78	31	20	24	25	11
1700	68	27	17	20	102	40	26	30	32	14
1900	85	34	22	26	127	50	32	38	40	18
2100	104	41	27	31	156	61	40	46	48	22
2300	125	49	32	37	186	73	48	56	58	27

Natural gas G20

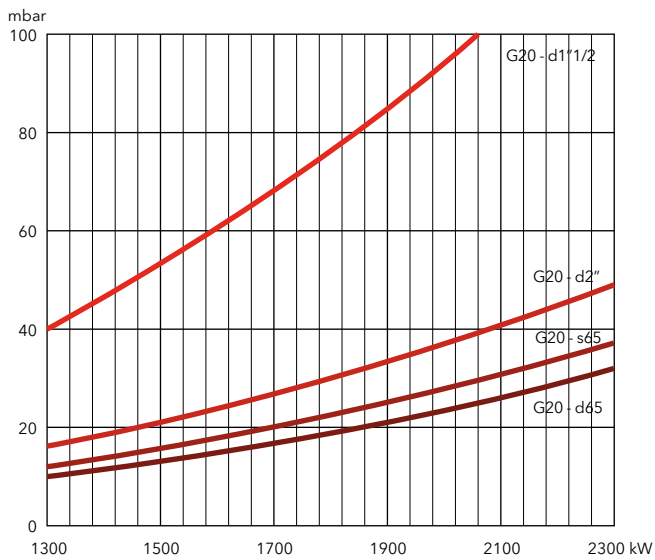

Natural gas G25

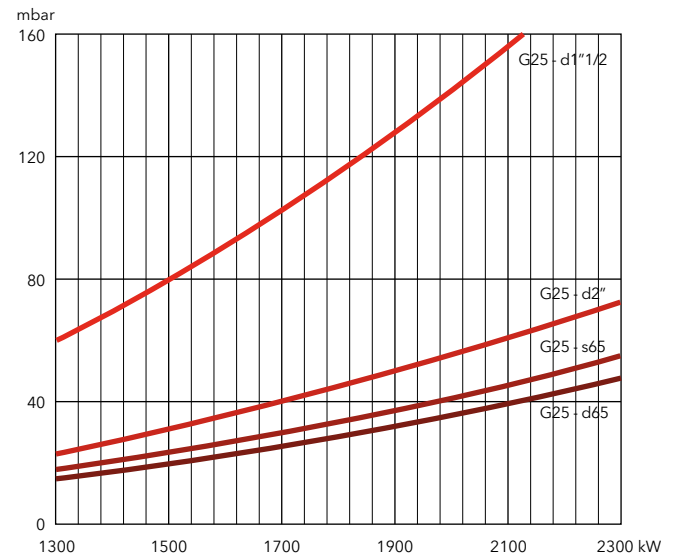

LPG

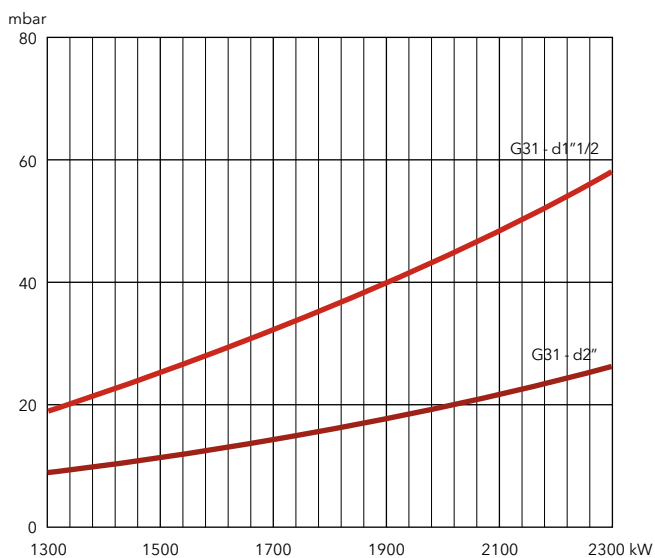

VG5.950 M V R / VG5.1200 M V R

150 ... 1200 kW

Two stage progressive/modulating electronic + fan speed control

- **Fuels:** natural gas (G20/G25, $H_u = 8,83...10,35 \text{ kWh/m}^3$); LPG (G31, $H_u = 25,89 \text{ kWh/m}^3$)
- **Emissions:** NOx < 120 mg/kWh (NCV), Low NOx class 2 burners according to EN676
- **Operation:** two stage progressive or modulating with the installation of a power regulator and dedicated probes (see page 218)
- **Protection level:** IP 21



TECHNICAL DATA

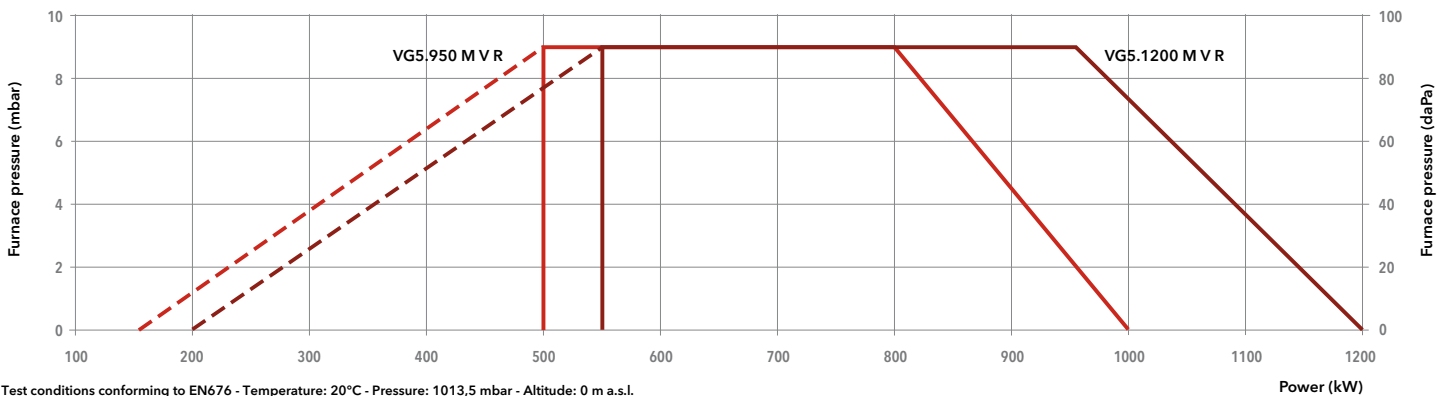

Model	VG5.950 M V R /TC			VG5.1200 M V R /TC				
Operation range	(150) 500 - 1000 kW			(200) 550 - 1200 kW				
Gas pressure	50 - 500 mbar			50 - 500 mbar				
Control box / flame detection	BT3... / ionization			BT3... / ionization				
Fan motor	230/400 V - 50 Hz - 1,5 kW			230/400 V - 50 Hz - 1,5 kW				
Electrical consumption	100 + 2200 W			100 + 2300 W				
Acoustic level (LpA)	77 dB(A)			77 dB(A)				
CE certificate	0085 CQ 0570			0085 CQ 0570				
Head length		KN	KL	KM	KN	KL	KM	
Complete burner code	VGD 40-065	s65-DN65/TC	3835443	3835444	3835445	3835458	3835459	3835460
	MBC1900	d65-DN65/TC	3835446	3835447	3835448	3835461	3835462	3835463
	MBC1200	d2"-Rp2"/TC	3835449	3835450	3835451	3835464	3835465	3835466
	MBC700	d1"1/2-Rp2"/TC	3835452	3835453	3835454	3835467	3835468	3835469
	MBC300	d3/4"-Rp1"1/4/TC	3835455	3835456	3835457	3835470	3835471	3835472

OTHER AVAILABLE VERSIONS

- Vent** Versions for continuous ventilation and post-ventilation
- PED** PED version for continuous operation

SCOPE OF SUPPLY

The burner is delivered in its package complete with:

- 1 burner head with flange seal and securing screws
- 1 compact gas train with gas filter; the gas filter is built-in for threaded valves (up to 2") and separated for flanged ones (DN65/80/100)
- 1 bag containing installation fittings
- 1 bag containing technical documentation (instruction manual, technical data, electrical diagram, exploded view and spare parts list)



DIMENSIONS (mm)

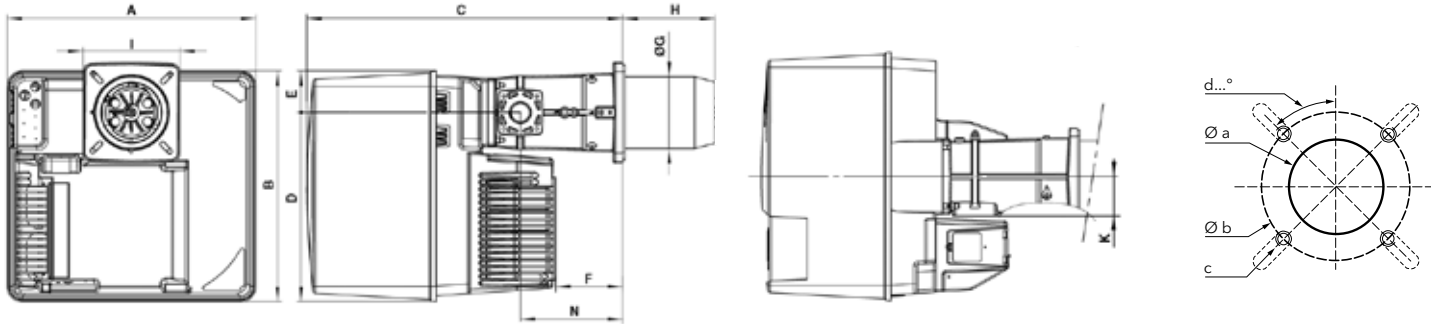

A	B	C	D	E	F	ØG	H			I	K	N
							KN	KM	KL			
581	549	752	450	99	164	170	215	325	435	230x238	89	244

Øa (mm)	b (mm)	c	d
195	220-260	M10	45°

Gas trains

Gas train "d":

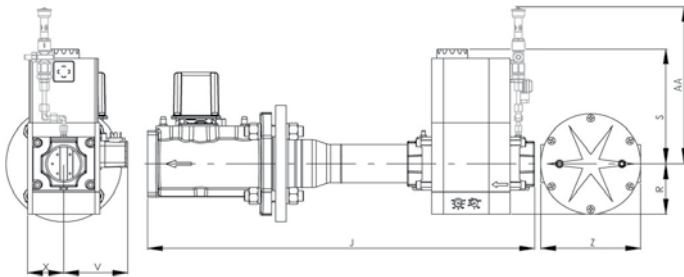

Model	J	R	S	V	X	Z	AA*
d65-DN65	490	183	245	110	98	290	385
d2"-Rp2"	700	96	330	125	81	-	385
d1"1/2-Rp2"	622	80	185	102	57	-	320
d3/4"-Rp1"1/4	460	60	173	88	58	-	320

Gas train "s":

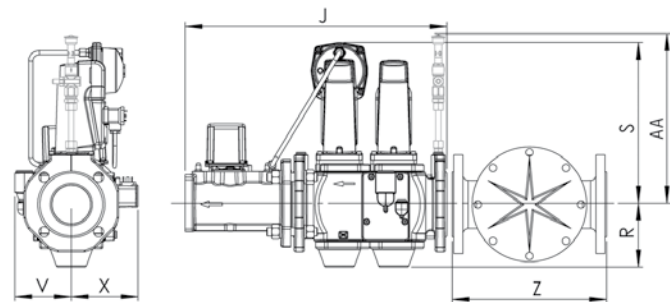

Model	J	R	S	V	X	Z	AA*
s65-DN65	490	118	300	106	126	290	365

*: for PED configuration

PACKAGING

The burner is delivered on a pallet in three packages containing:

- burner housing
- combustion head
- gas train and filter

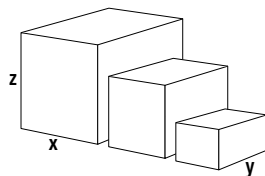

Component		Dimensions (mm)			Gross weight (kg)
		X	Y	Z	
Burner body	VG5.950 M V R	800	600	850	53
	VG5.1200 M V R	800	600	850	54
Combustion head	KN	780	265	280	12,3
	KL	1010	265	280	14,4
	KM	1010	265	280	13,4
Gas train	s65-DN65/TC	670	550	380	29
	d65-DN65/TC	670	550	380	17,2
	d2"-Rp2"/TC	670	550	380	12
	d1"1/2-Rp2"/TC	670	550	380	12
	d3/4"-Rp1"1/4/TC	590	390	180	7

VG5.950 M V R / VG5.1200 M V R

150 ... 1200 kW

Two stage progressive/modulating electronic + fan speed control

PRESSURE LOSS [BURNER HEAD + GAS TRAIN] (mbar)

VG5.950 M V R

Burner output (kW)	Natural gas G20 Hi = 10,35 kWh/m ³					Natural gas G25 Hi = 8,83 kWh/m ³					LPG G31	
	d3/4-Rp1"1/4	d1"1/2-Rp2"	d2"-Rp2"	d65-DN65	s65-DN65	d3/4-Rp1"1/4	d1"1/2-Rp2"	d2"-Rp2"	d65-DN65	s65-DN65	d1"1/2-Rp2"	d3/4-Rp1"1/4
500	31	10	7	6	6	46	15	11	9	9	17	8
600	45	15	9	9	9	67	22	16	12	13	24	11
700	61	20	13	12	12	91	30	22	17	18	32	15
800	79	26	17	15	15	118	39	28	22	23	42	20
900	124	33	21	19	19	149	49	35	28	29	53	25
1000	-	40	26	24	24	185	60	43	34	36	66	31

Natural gas G20

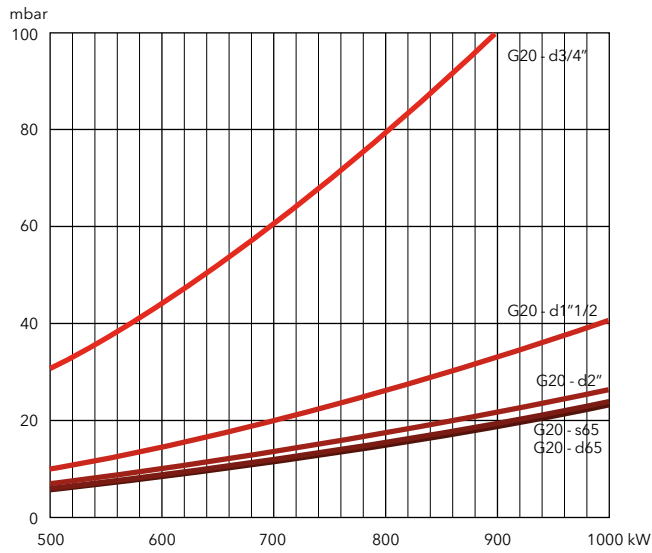

Natural gas G25

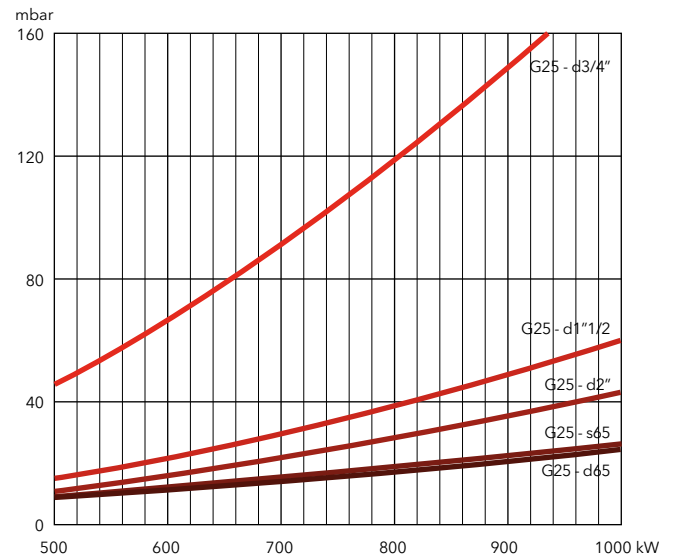

LPG

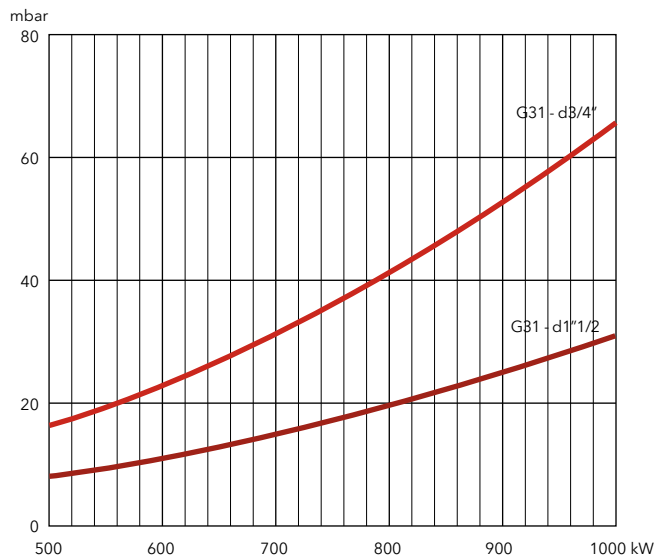



PRESSURE LOSS [BURNER HEAD + GAS TRAIN] (mbar)

VG5.1200 M V R

Burner output (kW)	Natural gas G20 Hi = 10,35 kWh/m ³					Natural gas G25 Hi = 8,83 kWh/m ³					LPG G31
	d3/4-Rp1"1/4	d1"1/2-Rp2"	d2"-Rp2"	d65-DN65	s65-DN65	d3/4-Rp1"1/4	d1"1/2-Rp2"	d2"-Rp2"	d65-DN65	s65-DN65	d1"1/2-Rp2"
700	58	17	10	8	9	86	25	14	12	13	10
800	75	22	13	10	11	112	32	19	16	17	14
900	95	27	16	13	14	142	41	24	20	21	17
1000	117	34	20	16	17	175	51	29	24	26	21
1100	142	41	24	20	21	213	62	36	30	32	26
1200	169	49	28	24	25	252	73	42	35	37	31

Natural gas G20

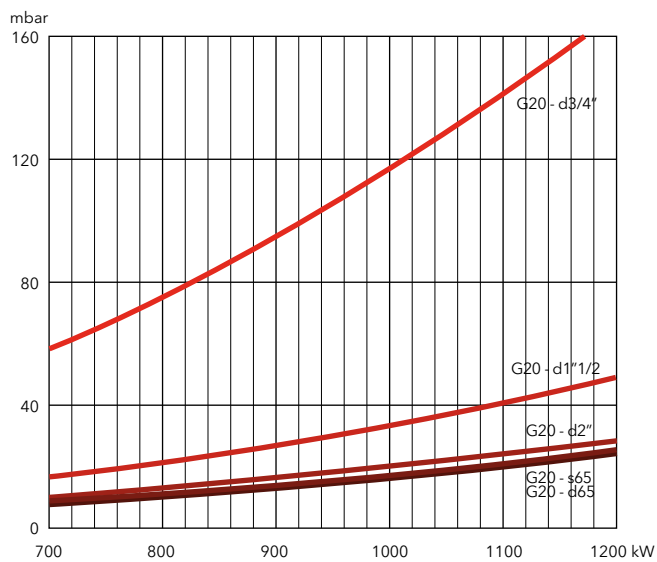

Natural gas G25

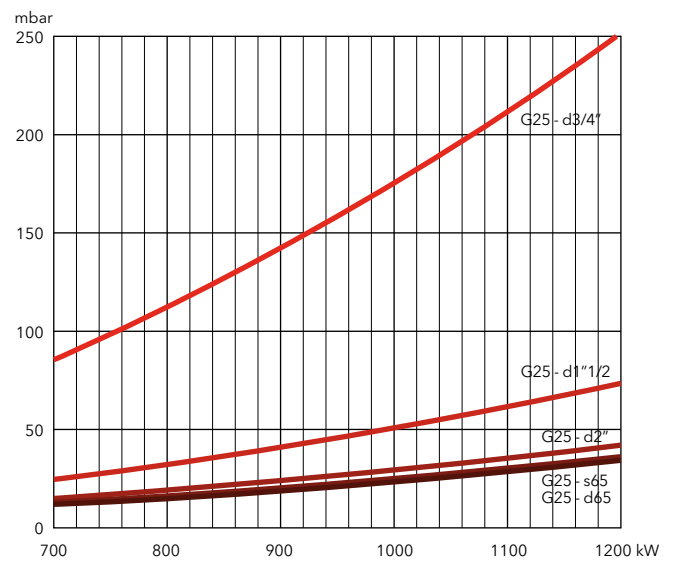

LPG

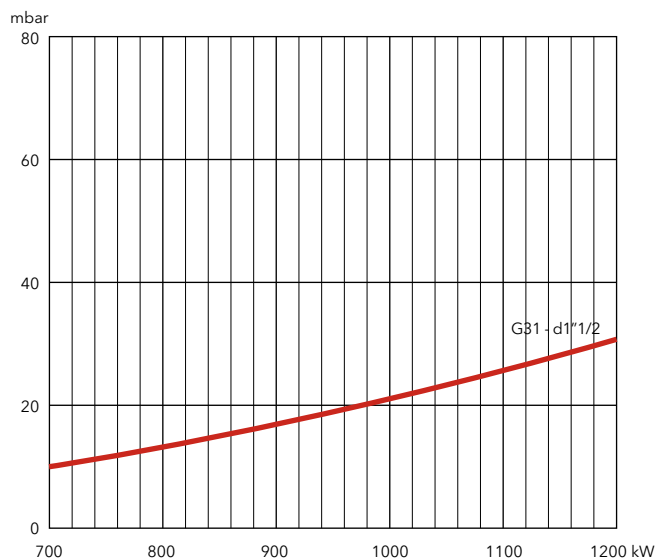

VG6.1600 M V R / VG6.2100 M V R

200 ... 2300 kW

Two stage progressive/modulating electronic + fan speed control



- **Fuels:** natural gas (G20/G25, $H_u = 8,83...10,35 \text{ kWh/m}^3$); LPG (G31, $H_u = 25,89 \text{ kWh/m}^3$)
- **Emissions:** $\text{NO}_x < 120 \text{ mg/kWh}$ (NCV), Low NO_x class 2 burners according to EN676
- **Operation:** two stage progressive or modulating with the installation of a power regulator and dedicated probes (see page 218)
- **Protection level:** IP 21

TECHNICAL DATA

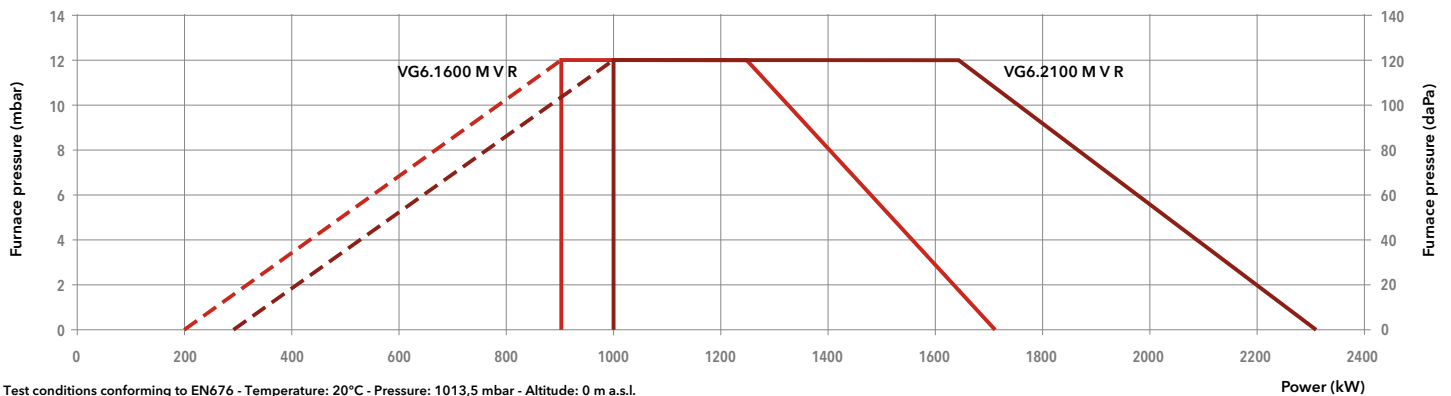

Model	VG6.1600 M V R /TC			VG6.2100 M V R /TC			
Operation range	(200) 900 - 1700 kW			(300) 1000 - 2300 kW			
Gas pressure	50 - 500 mbar			50 - 500 mbar			
Control box / flame detection	BT3... / IRD 1020.1			BT3... / IRD 1020.1			
Fan motor	230/400 V - 50 Hz - 2,2 kW			230/400 V - 50 Hz - 2,5 kW			
Electrical consumption	100 + 2500 W			100 + 3500 W			
Acoustic level (LpA)	77 dB(A)			79 dB(A)			
CE certificate	0085 CQ 0570			0085 CQ 0570			
Head length	KN	KM	KL	KN	KM	KL	
Complete	VGD 40-065 s65-DN65/TC	3835473	3835475	3835474	3835485	3835487	3835486
burner code	MBC1900 d65-DN65/TC	3835476	3835478	3835477	3835488	3835490	3835489
	MBC1200 d2"-Rp2"/TC	3835479	3835481	3835480	3835491	3835493	3835492
	MBC700 d1"1/2-Rp2"/TC	3835482	3835484	3835483	3835494	3835496	3835495

OTHER AVAILABLE VERSIONS

- Vent** Versions for continuous ventilation and post-ventilation
- PED** PED version for continuous operation

SCOPE OF SUPPLY

The burner is delivered in its package complete with:

- 1 burner head with flange seal and securing screws
- 1 compact gas train with gas filter; the gas filter is built-in for threaded valves (up to 2") and separated for flanged ones (DN65/80/100)
- 1 bag containing installation fittings
- 1 bag containing technical documentation (instruction manual, technical data, electrical diagram, exploded view and spare parts list)



DIMENSIONS (mm)

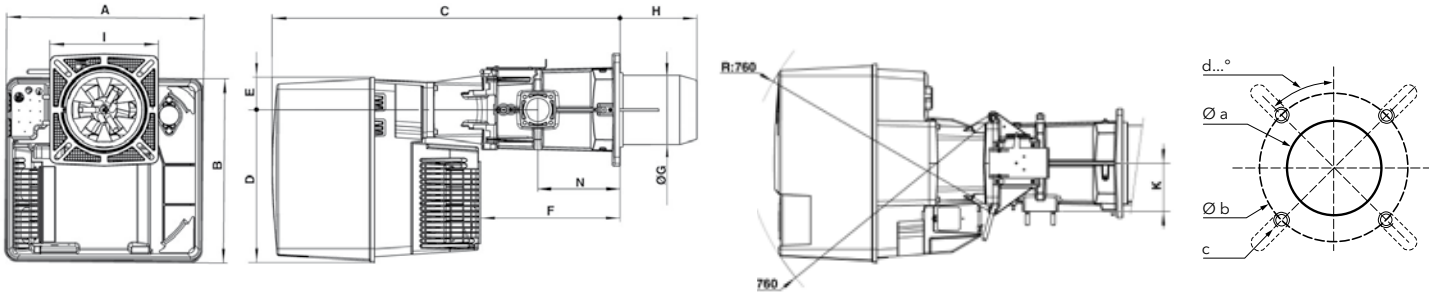

A	B	C	D	E	F	ØG	H			I	K	N
							KN	KM	KL			
592	553	1050	456	97	421	227	270	370	470	326x335	144	247

Øa (mm)	b (mm)	c	d
250	300-400	M12	45°

Gas trains

Gas train "d":

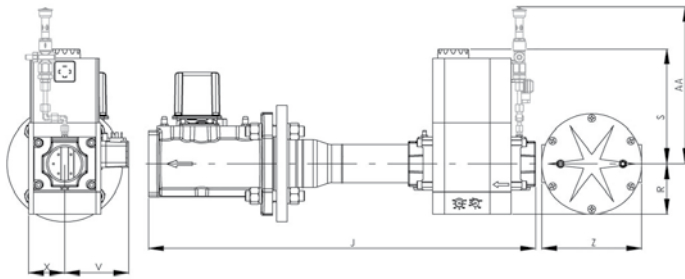

Model	J	R	S	V	X	Z	AA*
d65-DN65	490	183	245	110	98	290	385
d2"-Rp2"	700	96	330	125	81	-	385
d1"1/2-Rp2"	622	80	185	102	57	-	320

Gas train "s":

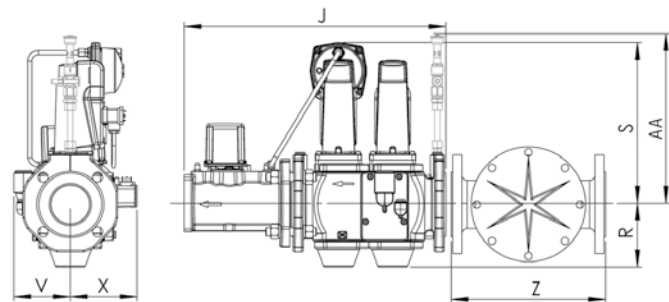

Model	J	R	S	V	X	Z	AA*
s65-DN65	490	118	300	106	126	290	365

*: for PED configuration

PACKAGING

The burner is delivered on a pallet in three packages containing:

- burner housing
- combustion head
- gas train and filter

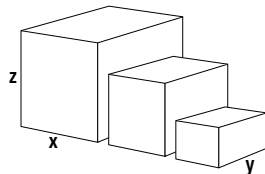

Component		Dimensions (mm)			Gross weight (kg)
		X	Y	Z	
Burner body	VG6.1600 M V R	800	600	850	67,8
	VG6.2100 M V R	800	600	850	69,2
Combustion head	KN	1000	380	420	26,7
	KL	1100	380	430	29,4
	KM	1100	380	430	28
Gas train	s65-DN65/TC	670	550	380	29,4
	d65-DN65/TC	670	550	380	33
	d2"-Rp2"/TC	670	550	380	16,5
	d1"1/2-Rp2"/TC	670	550	380	14,3

VG6.1600 M V R / VG6.2100 M V R

200 ... 2300 kW

Two stage progressive/modulating electronic + fan speed control

PRESSURE LOSS [BURNER HEAD + GAS TRAIN] (mbar)

VG6.1600 M V R

Burner output (kW)	Natural gas G20 Hi = 10,35 kWh/m ³				Natural gas G25 Hi = 8,83 kWh/m ³				LPG G31
	d1"1/2-Rp2"	d2"-Rp2"	d65-DN65	s65-DN65	d1"1/2-Rp2"	d2"-Rp2"	d65-DN65	s65-DN65	d1"1/2-Rp2"
800	17	7	5	6	25	10	8	9	5
1000	25	11	8	9	37	16	11	13	7
1200	36	16	11	13	54	23	16	19	10
1400	49	21	15	17	73	32	22	25	13
1600	64	28	19	22	96	41	29	33	17

Natural gas G20

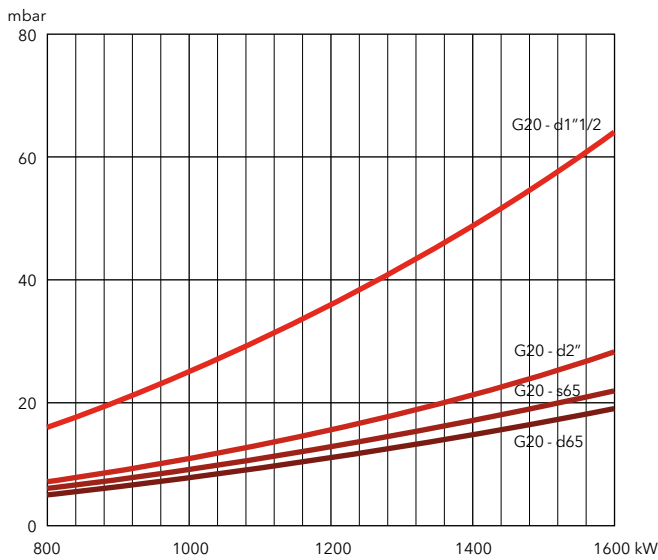

Natural gas G25

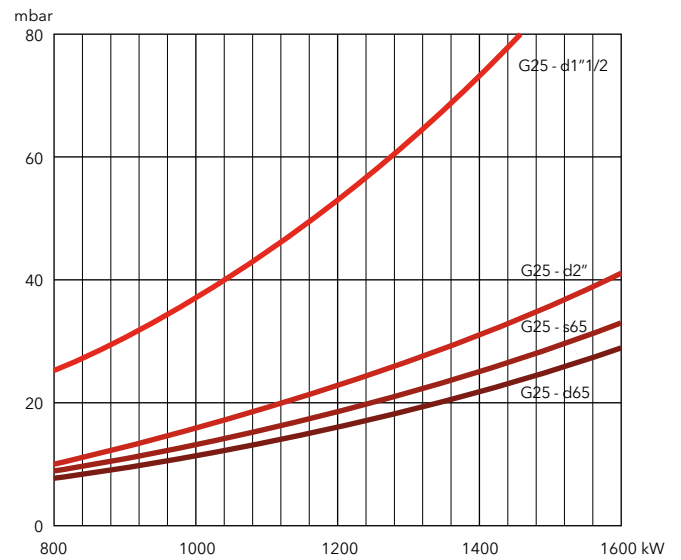

LPG

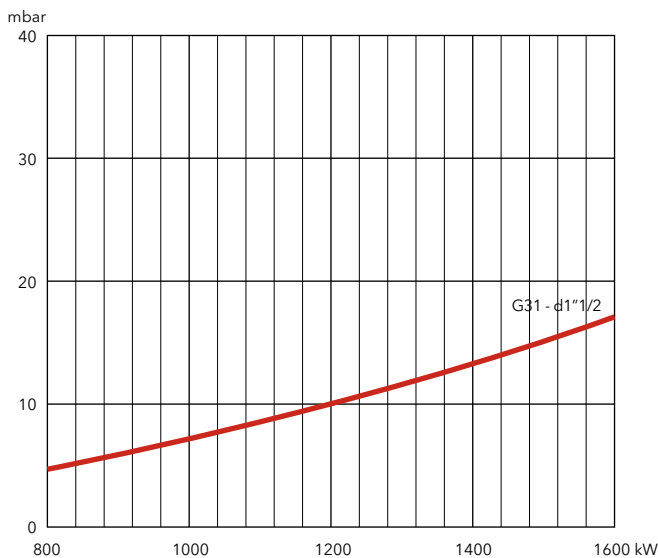



PRESSURE LOSS [BURNER HEAD + GAS TRAIN] (mbar)

VG6.2100 M V R

Burner output (kW)	Natural gas G20 Hi = 10,35 kWh/m ³				Natural gas G25 Hi = 8,83 kWh/m ³				LPG G31 Hi = 25,89 kWh/m ³	
	d1"1/2-Rp2"	d2"-Rp2"	d65-DN65	s65-DN65	d1"1/2-Rp2"	d2"-Rp2"	d65-DN65	s65-DN65	d1"1/2-Rp2"	d2"-Rp2"
1300	40	16	10	12	60	24	15	18	19	9
1500	53	21	13	16	78	31	20	24	25	11
1700	68	27	17	20	102	40	26	30	32	14
1900	85	34	22	26	127	50	32	38	40	18
2100	104	41	27	31	156	61	40	46	48	22
2300	125	49	32	37	186	73	48	56	58	27

Natural gas G20

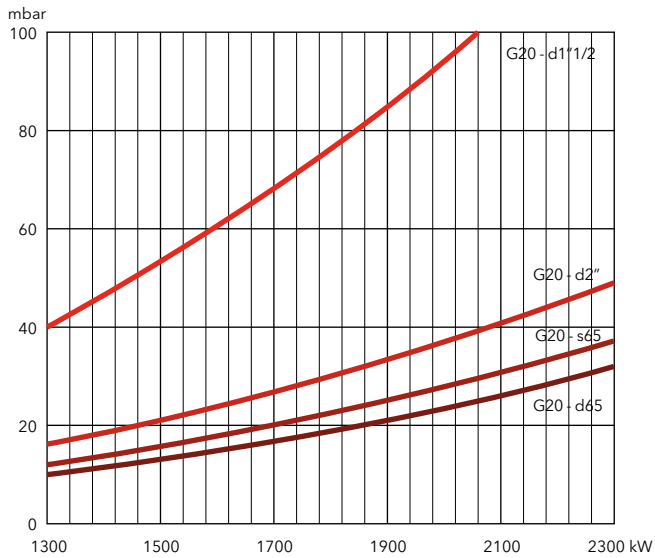

Natural gas G25

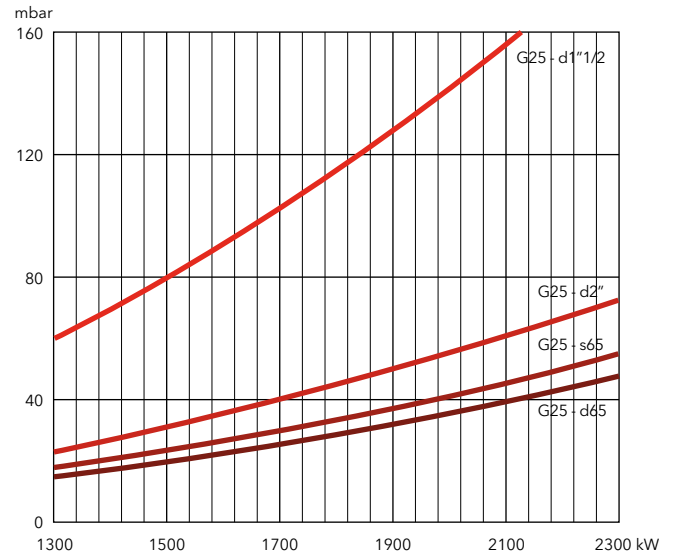

LPG

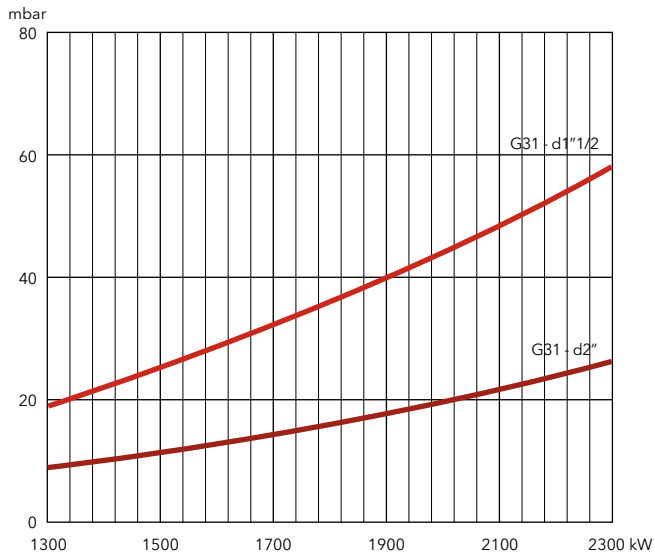

- **Fuels:** natural gas (G20/G25, $H_u = 8,83...10,35 \text{ kWh/m}^3$);
light oil (viscosity $6 \text{ mm}^2/\text{s}$ at 20°C , $H_u = 11,86 \text{ kWh/kg}$)
- **Emissions:** Low NOx class 2 in gas ($\leq 120 \text{ mg/kWh}$) according to EN676
Low NOx class 2 in light oil ($\leq 185 \text{ mg/kWh}$) according to EN267
- **Protection level:** IP 21



TECHNICAL DATA

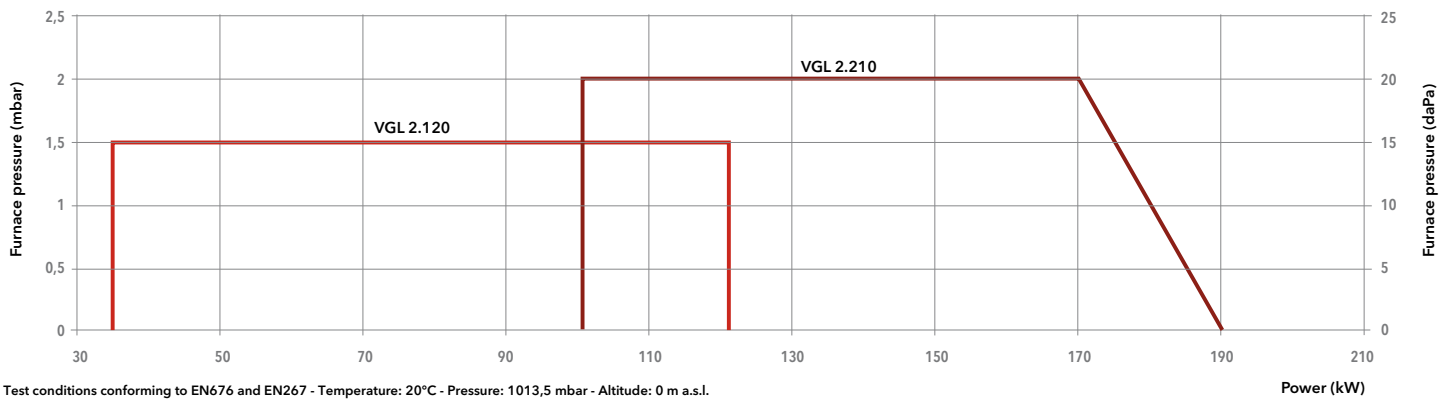

Model	VGL2.120	VGL2.210
Operation range	35 - 120 kW	100 - 190 kW
Gas pressure	20 - 300 mbar	20 - 300 mbar
Control box / flame detection	TCG1... / IRD 1020	TCG1... / IRD 1020
Fan motor	230 V - 50 Hz - 160 W	230 V - 50 Hz - 130 W
Nozzle	1,85 US gal/h 45°S	2,75 US gal/h 45°B
Electrical consumption	186 W	246 W
Acoustic level (LpA)	62 dB(A)	65,2 dB(A)
CE certificate	1312 BU 5219	1312 BU 5219
Head length	KL	KL
Complete burner MB-DLE 407 d3/4"-Rp3/4"	3833494	3833495

OTHER AVAILABLE VERSIONS

Versions for continuous ventilation and post-ventilation

SCOPE OF SUPPLY

The burner is delivered in its package complete with:

- 1 gas connection flange
- 1 compact gas train with gas filter; the gas filter is built-in for threaded valves (up to 2") and separated for flanged ones (DN65/80/100)
- 1 burner flange with insulation
- 1 bag containing installation fittings
- 1 bag containing technical documentation (instruction manual, technical data, electrical diagram, exploded view and spare parts list)

DIMENSIONS (mm)

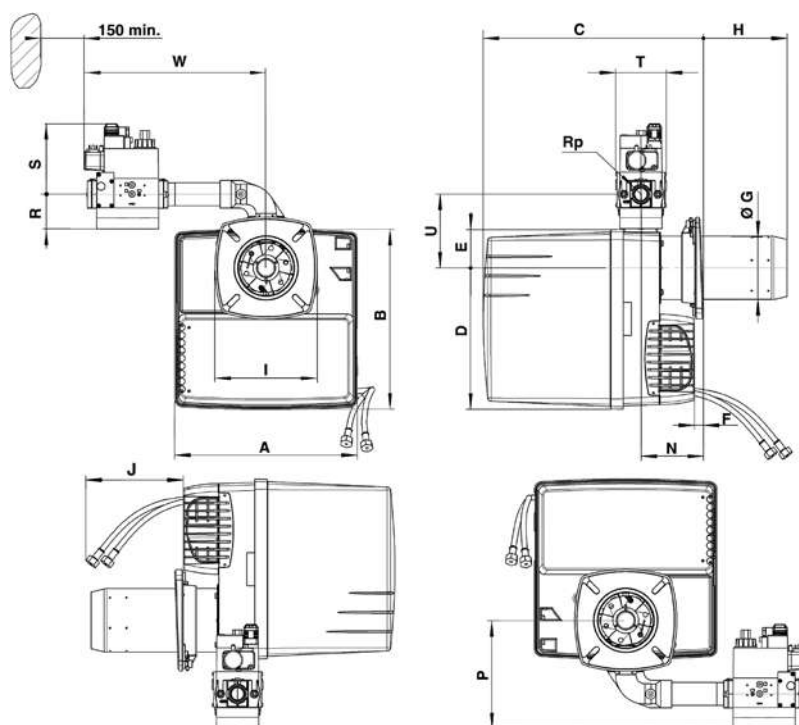

A	B	C	D	E	F min	ØG	H	I	J	N min	P	Rp	R	S	T	U	W
		KL					KL										
331	325	398...638	256	69	15	115	30...270	185	700	113	115	3/4"	46	140	120	133	330

Connecting flange

Øa (mm)	b (mm)	c	d
130-140	172-184	M8	45°

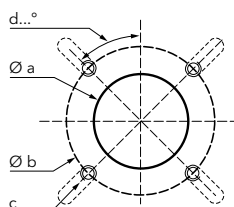

PACKAGING

The burner is delivered in a single package containing all the components

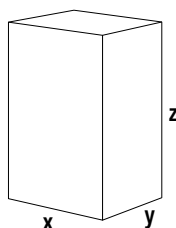

Burner	Dimensions (mm)			Gross weight (kg)
	X	Y	Z	
VGL2.120	400	400	770	23
VGL2.210	400	400	770	24

VGL3.290 D / VGL3.360 D

95 ... 360 kW

Two stages in gas / Two stages in light oil

- **Fuels:** natural gas (G20/G25, $H_u = 8,83...10,35 \text{ kWh/m}^3$);
light oil (viscosity $6 \text{ mm}^2/\text{s}$ at 20°C , $H_u = 11,86 \text{ kWh/kg}$)
- **Emissions:** Low NOx class 3 in gas ($\leq 80 \text{ mg/kWh}$) according to EN676
Low NOx class 2 in light oil ($\leq 185 \text{ mg/kWh}$) according to EN267
- **Protection level:** IP 41



TECHNICAL DATA

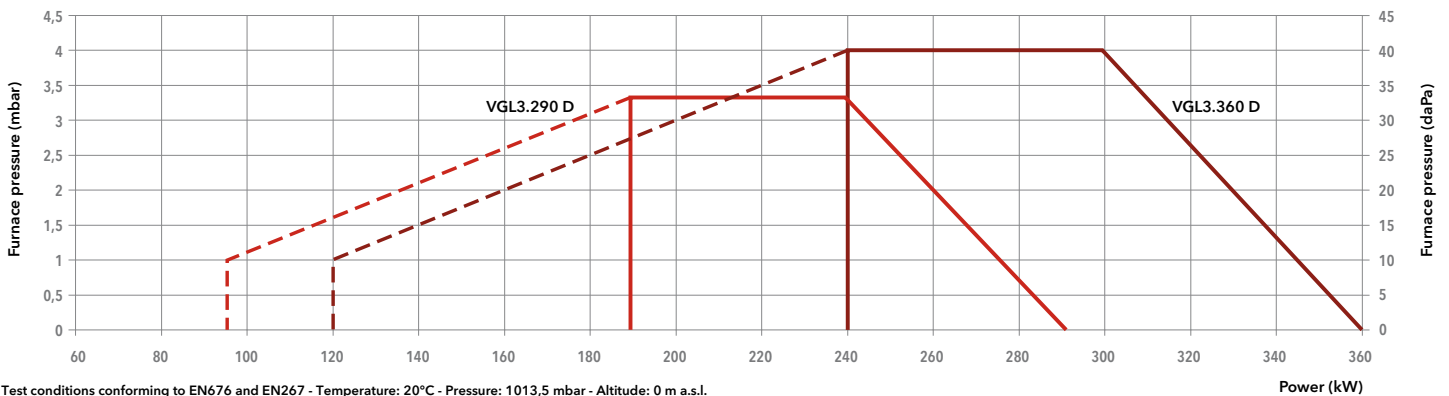

Test conditions conforming to EN676 and EN267 - Temperature: 20°C - Pressure: 1013,5 mbar - Altitude: 0 m a.s.l.

Model	VGL3.290 D		VGL3.360 D	
Operation range	(95) 190 - 290 kW		(120) 240 - 360 kW	
Gas pressure	20 - 300 mbar		20 - 300 mbar	
Control box / flame detection	TCG2... / IRD 1020		TCG2... / IRD 1020	
Fan motor	230 V - 50 Hz - 300 W		230 V - 50 Hz - 300 W	
Electrical consumption	512 W		512 W	
Acoustic level (LpA)	67 dB(A)		69 dB(A)	
CE certificate	0085 CP 0304		0085 CP 0304	
Head length	KN	KL	KN	KL
Complete burner code	MB-ZRDLE 420 d1"1/2-Rp2"	-	3834467	3834468
	MB-ZRDLE 412 d1"1/4-Rp1"1/4"	3834461	3834465	3834466
	MB-ZRDLE 407 d3/4"-Rp3/4"	3834459	3834460	3834463

OTHER AVAILABLE VERSIONS

 Versions for continuous ventilation and post-ventilation

SCOPE OF SUPPLY

The burner is delivered in its package complete with:

- 1 burner head with flange seal and securing screws
- 1 compact gas train with gas filter; the gas filter is built-in for threaded valves (up to 2") and separated for flanged ones (DN65/80/100)
- 1 bag containing installation fittings
- 1 bag containing technical documentation (instruction manual, technical data, electrical diagram, exploded view and spare parts list)



DIMENSIONS (mm)

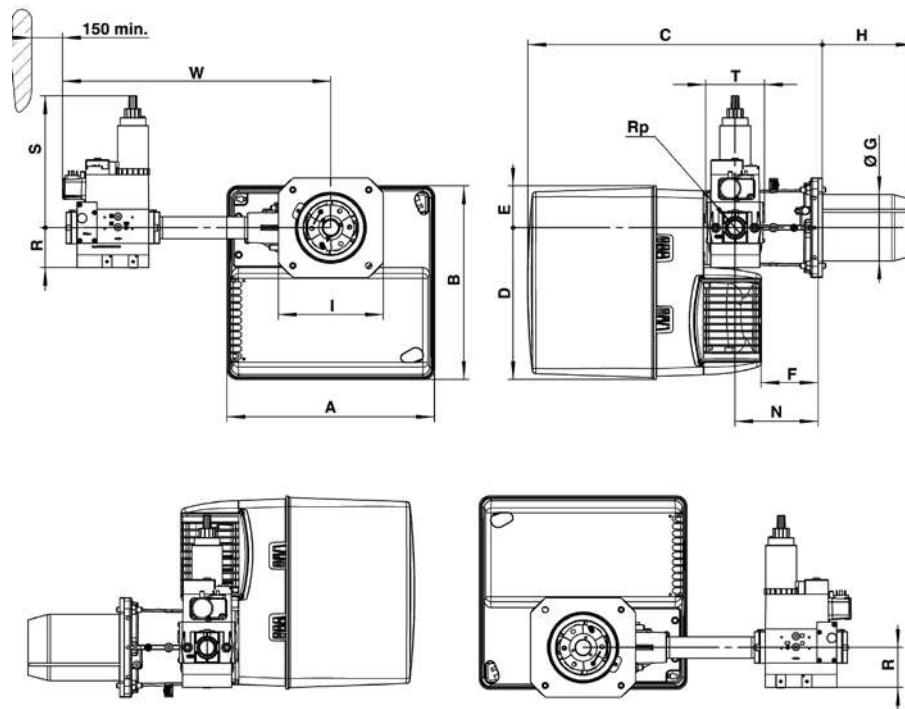

Gas train model	A	B	C	D	E	F	ØG	H		I	N	Rp	R	S	T	W
								KN	KL							
d1"1/2-Rp2"	406	379	576	297	82	120	130	180	320	195x205	170	2"	80	330	100	603
d1"1/4-Rp1"1/4	406	379	576	297	82	120	130	180	320	195x205	170	1"1/4	55	260	145	526
d3/4"-Rp3/4"	406	379	576	297	82	120	130	180	320	195x205	170	3/4"	46	210	120	479

Connecting flange

Øa (mm)	b (mm)	c	d
155-190	175-220	M10	45°

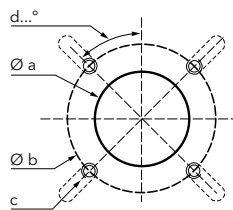

PACKAGING

The burner is delivered on a pallet in three packages containing:

- burner housing
- combustion head
- gas train and filter

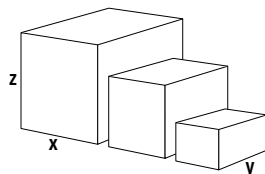

Component		Dimensions (mm)			Gross weight (kg)
		X	Y	Z	
Burner body	VGL3.290 D	440	400	520	21
	VGL3.360 D	440	400	520	22
Combustion head	KN	650	210	260	6
	KL	780	210	260	7
Gas train	d1"1/2-Rp2"	600	400	240	14
	d1"1/4-Rp1"1/4	440	320	240	10
	d3/4"-Rp3/4"	440	320	240	7

VGL3.290 D / VGL3.360 D

95 ... 360 kW

Two stages in gas / Two stages in light oil

PRESSURE LOSS [BURNER HEAD + GAS TRAIN] (mbar)

VGL3.290 D

Burner output (kW)	Natural gas G20 Hi = 10,35 kWh/m ³		Natural gas G25 Hi = 8,83 kWh/m ³	
	d3/4"-Rp3/4"	d1"1/4-Rp1"1/4	d3/4"-Rp3/4"	d1"1/4-Rp1"1/4
190	14	6	18	6
210	17	8	22	8
230	20	10	26	10
250	23	11	31	11
270	27	13	37	13
290	32	16	43	16

Natural gas G20

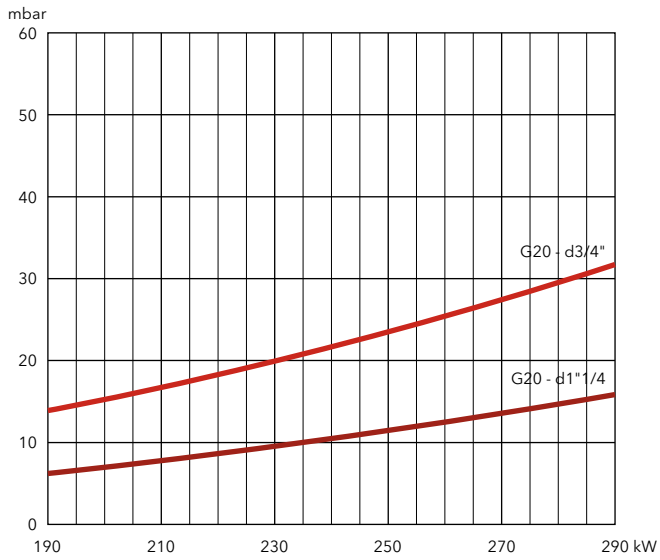

Natural gas G25

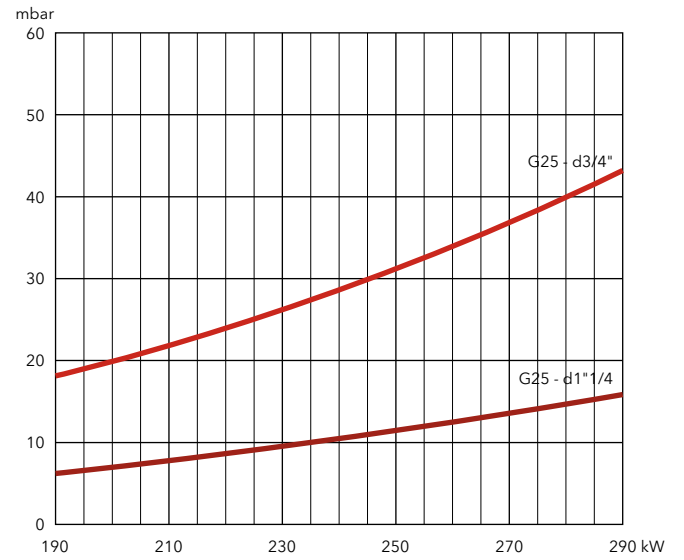



PRESSURE LOSS [BURNER HEAD + GAS TRAIN] (mbar)

VGL3.360 D

Burner output (kW)	Natural gas G20 Hi = 10,35 kWh/m ³		Natural gas G25 Hi = 8,83 kWh/m ³		
	d3/4"-Rp3/4"	d1"1/4-Rp1"1/4	d3/4"-Rp3/4"	d1"1/4-Rp1"1/4	d1"1/2-Rp2"
240	22	9	25	9	8
280	29	12	35	12	11
320	38	16	46	16	14
360	49	21	59	21	18

Natural gas G20

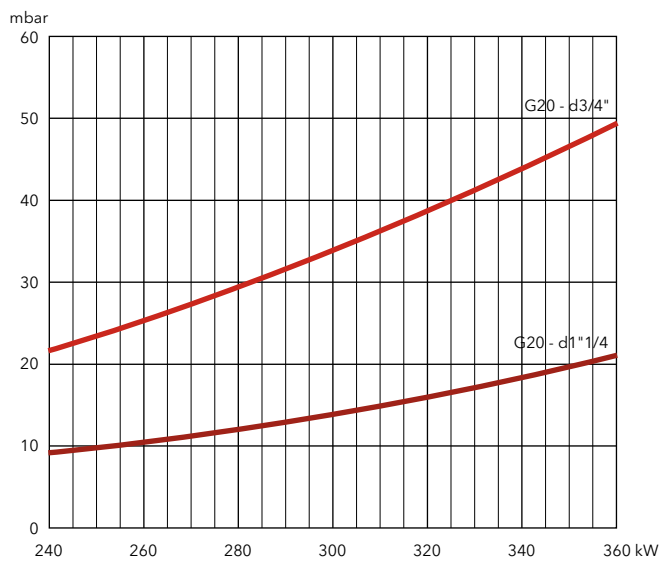

Natural gas G25

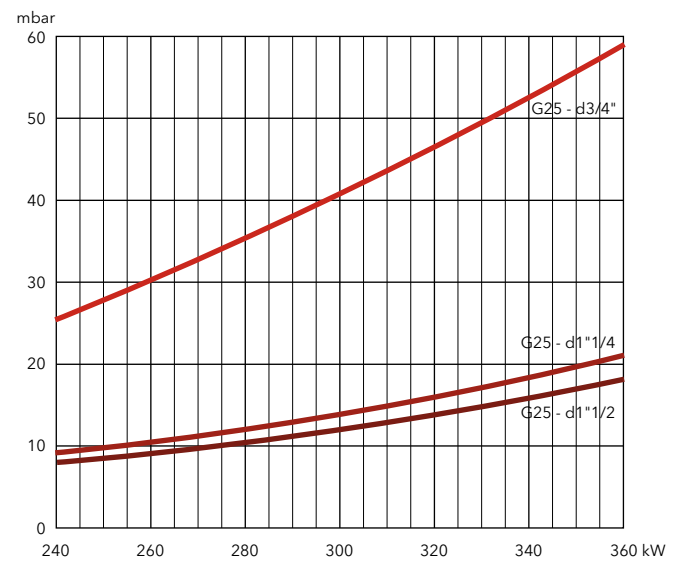

VGL4.460 DP / VGL4.610 DP

168 ... 610 kW

Two stage progressive/modulating pneumatic in gas / Two stages in oil

- **Fuels:** natural gas (G20/G25, $H_u = 8,83...10,35 \text{ kWh/m}^3$);
light oil (viscosity $6 \text{ mm}^2/\text{s}$ at 20°C , $H_u = 11,86 \text{ kWh/kg}$)
- **Emissions:** Low NOx class 3 in gas ($\leq 80 \text{ mg/kWh}$) according to EN676
Low NOx class 2 in light oil ($\leq 185 \text{ mg/kWh}$) according to EN267
- **Operation:** two stage progressive or modulating with the installation of a power regulator and dedicated probes (see page 218) in gas and two stages in light oil
- **Protection level:** IP 41



TECHNICAL DATA

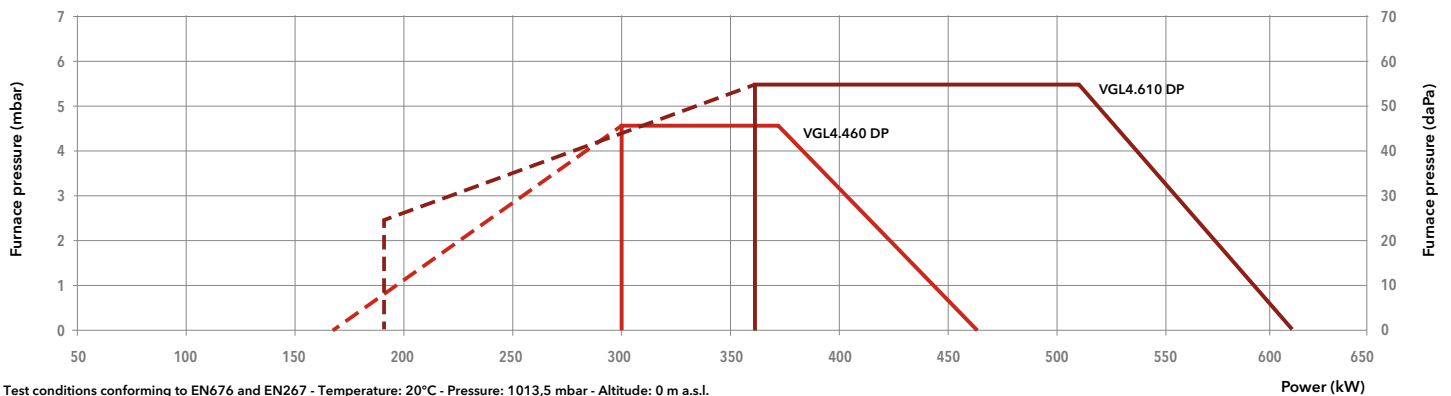

Test conditions conforming to EN676 and EN267 - Temperature: 20°C - Pressure: 1013,5 mbar - Altitude: 0 m a.s.l.

Model	VGL4.460 DP		VGL4.610 DP	
Operation range	(168) 300 - 460 kW		(190) 360 - 610 kW	
Gas pressure	20 - 300 mbar		20 - 300 mbar	
Control box / flame detection	TCG5... (gas), TCH2... (oil) / IRD1020 (gas), QRB1 (oil)		TCG5... (gas), TCH2... (oil) / IRD1020 (gas), QRB1 (oil)	
Fan motor	230 V - 50 Hz - 420 W		230 V - 50 Hz - 750 W	
Electrical consumption	68 + 522 W		68 + 720 W	
Acoustic level (LpA)	70 dB(A)		71 dB(A)	
CE certificate	0085 CP 0304		0085 CP 0304	
Head length	KN	KL	KN	KL
Complete burner code	MB-VEF 420 d1"1/2-Rp2"	3834576	3834582	3834583
	MB-VEF 412 d1"1/4-Rp1"1/4	3834574	3834580	3834581
	MB-VEF 407 d3/4"-Rp1"	3834572	3834578	3834579

OTHER AVAILABLE VERSIONS

 Versions for continuous ventilation and post-ventilation

SCOPE OF SUPPLY

The burner is delivered in its package complete with:

- 1 burner head with flange seal and securing screws
- 1 compact gas train with gas filter; the gas filter is built-in for threaded valves (up to 2") and separated for flanged ones (DN65/80/100)
- 1 bag containing installation fittings
- 1 bag containing technical documentation (instruction manual, technical data, electrical diagram, exploded view and spare parts list)

DIMENSIONS (mm)

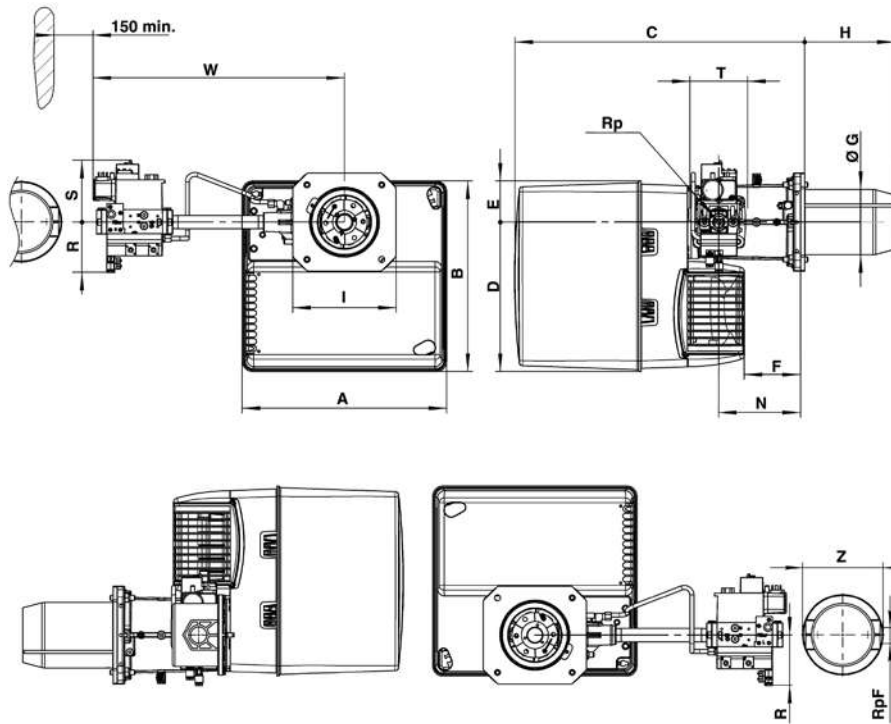

Gas train model	A	B	C	D	E	F	Ø G	H		I	N	Rp	R	S	T	W	RpF	Z
								KN	KL									
d1"1/2-Rp2"	465	475	640	377	97	149	150	220	360	245	195	2"	100	185	100	613	-	-
d1"1/4-Rp1"1/4	465	475	640	377	97	149	150	220	360	245	195	1"1/4	80	175	145	536	-	-
d3/4"-Rp1"	465	475	640	377	97	149	150	220	360	245	195	1"	70	160	120	489	1"	160

Connecting flange

Øa (mm)	b (mm)	c	d
190-240	200-270	M10	45°

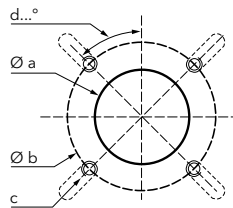

PACKAGING

The burner is delivered on a pallet in three packages containing:

- burner housing
- combustion head
- gas train and filter

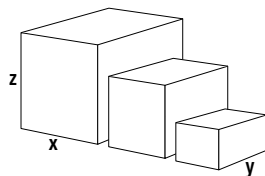

Component		Dimensions (mm)			Gross weight (kg)
		X	Y	Z	
Burner body	VGL4.460 DP	490	490	590	28,6
	VGL4.610 DP	490	490	590	32,7
Combustion head	KN	750	260	295	8,9
	KL	895	260	295	10,1
Gas train	d1"1/2-Rp2"	670	550	380	12
	d1"1/4-Rp1"1/4	600	400	240	11
	d3/4"-Rp1"	600	400	240	7

VGL4.460 DP / VGL4.610 DP

168 ... 610 kW

Two stage progressive/modulating pneumatic in gas / Two stages in oil

PRESSURE LOSS [BURNER HEAD + GAS TRAIN] (mbar)

VGL4.460 DP

Burner output (kW)	Natural gas G20 Hi = 10,35 kWh/m ³		Natural gas G25 Hi = 8,83 kWh/m ³		
	d3/4"-Rp3/4"	d1"1/4-Rp1"1/4	d3/4"-Rp3/4"	d1"1/4-Rp1"1/4	d1"1/2-Rp2"
300	37	7	50	13	8
340	47	10	65	17	10
380	59	12	81	21	13
420	72	15	99	26	15
460	86	18	118	31	19

Natural gas G20

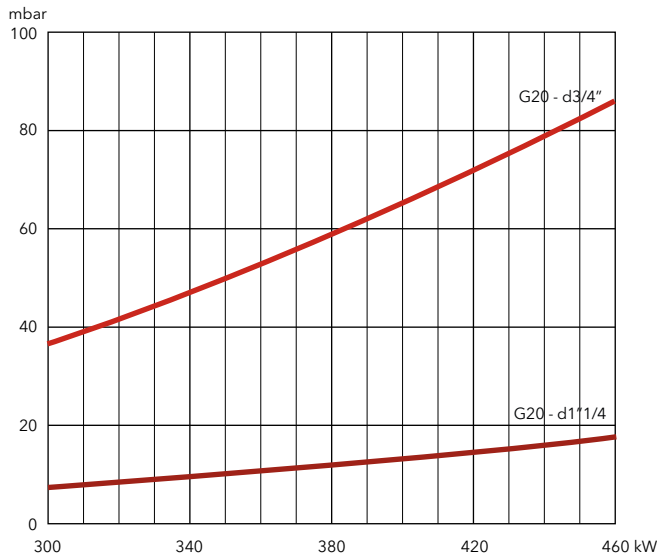

Natural gas G25

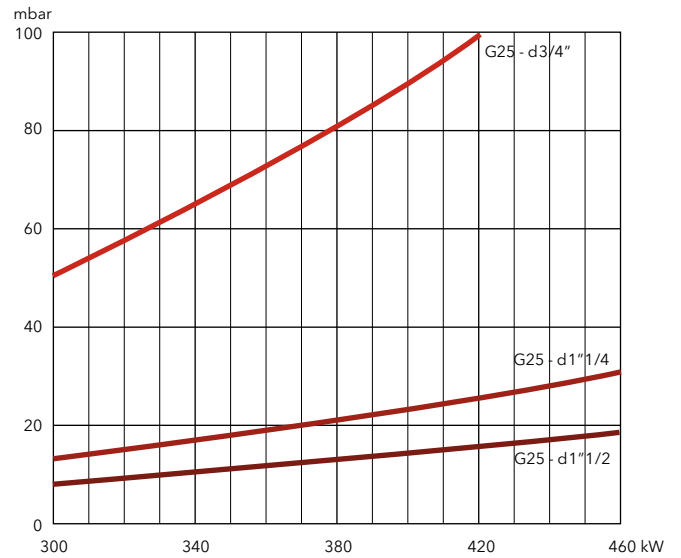



PRESSURE LOSS [BURNER HEAD + GAS TRAIN] (mbar)

VGL4.610 DP

Burner output (kW)	Natural gas G20 Hi = 10,35 kWh/m ³			Natural gas G25 Hi = 8,83 kWh/m ³	
	d3/4"-Rp3/4"	d1"1/4-Rp1"1/4	d1"1/2-Rp2"	d1"1/4-Rp1"1/4	d1"1/2-Rp2"
300	51	9	5	12	8
400	91	16	9	21	14
500	142	24	15	33	22
600	204	35	21	48	32

Natural gas G20

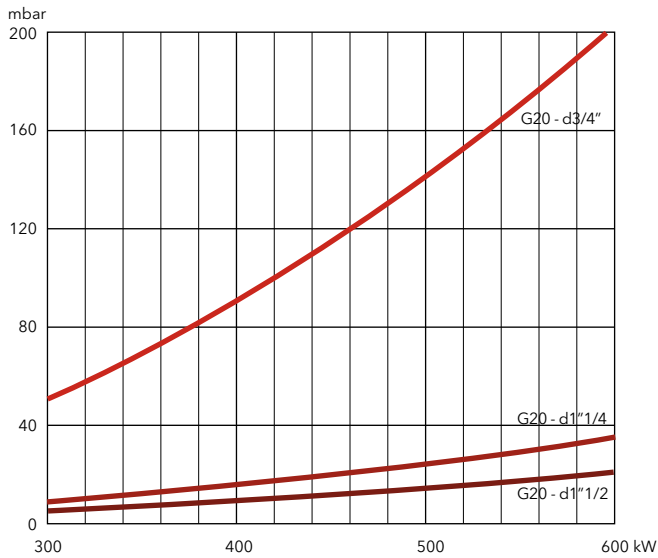

Natural gas G25

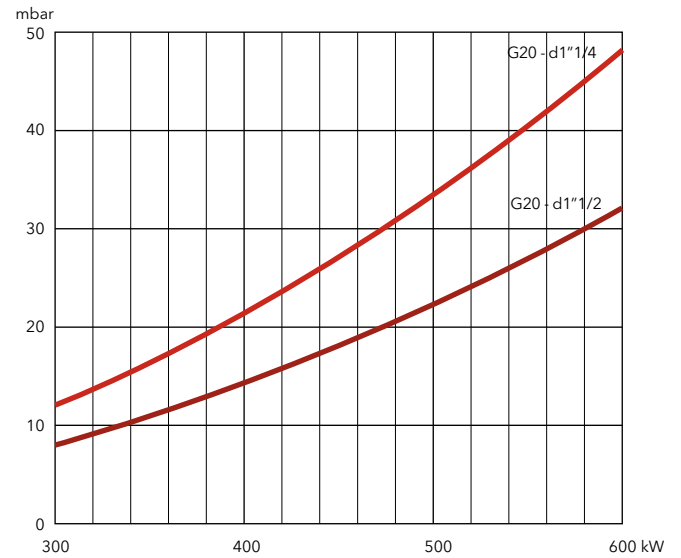

VGL5.700 M / VGL5.1000 M

200 ... 1000 kW

Two stage progressive/modulating electronic in gas / Three stages in oil

- **Fuels:** natural gas (G20/G25, $H_u = 8,83...10,35 \text{ kWh/m}^3$);
light oil (viscosity $6 \text{ mm}^2/\text{s}$ at 20°C , $H_u = 11,86 \text{ kWh/kg}$)
- **Emissions:** Low NOx class 3 in gas ($\leq 80 \text{ mg/kWh}$) according to EN676
Low NOx class 2 in light oil ($\leq 185 \text{ mg/kWh}$) according to EN267
- **Operation:** two stage progressive or modulating with the installation of a power regulator and dedicated probes (see page 218) in gas and three stages in light oil
- **Protection level:** IP 41



TECHNICAL DATA

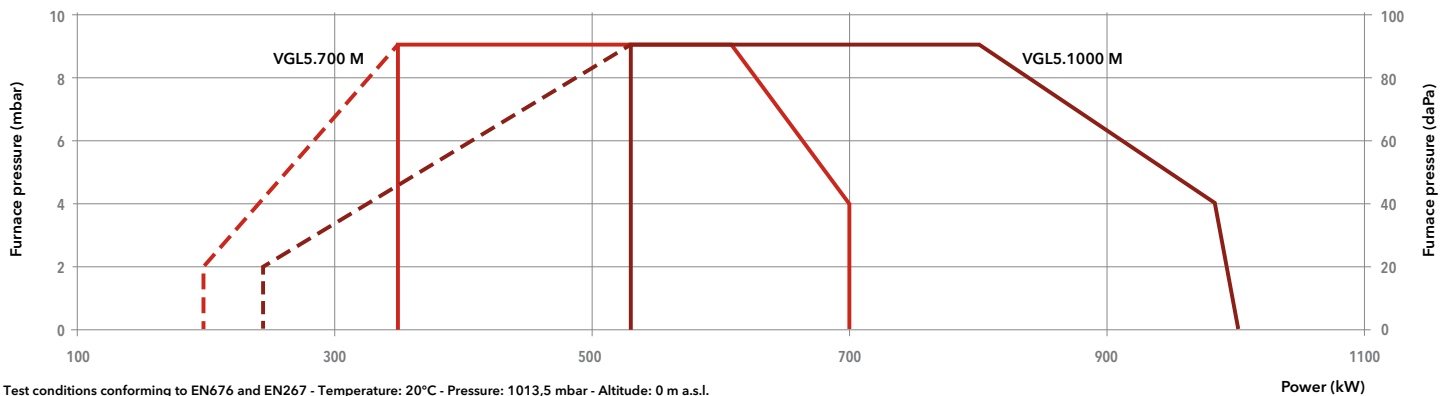

Model	VGL5.700 M /TC			VGL5.1000 M /TC				
Operation range	(200) 350 – 700 kW			(240) 530 – 1000 kW				
Gas pressure	20 – 300 mbar			20 – 300 mbar				
Control box / flame detection	BT3... / QRA 2			BT3... / QRA 2				
Fan motor	230/400 V – 50 Hz – 1,1 kW			230/400 V – 50 Hz – 1,5 kW				
Nozzle	4,5 US gal/h 45°B / 5 US gal/h 45°B			5 US gal/h 45°B / 8,5 US gal/h 45°B				
Electrical consumption	2000 W			2200 W				
Acoustic level (LpA)	78 dB(A)			81 dB(A)				
CE certificate	1312 AQ 924			1312 AQ 925				
Head length		KN	KL	KM	KN	KL	KM	
Complete burner code	VDG 40-065	s65-DN65	-	-	-	3836654	3836656	3836655
	MBC1900	d65-DN65	-	-	-	3836657	3836659	3836658
	MBC1200	d2"-Rp2"	3836645	3836647	3836646	3836660	3836662	3836661
	MBC700	d1 1/2"-Rp2"	3836648	3836650	3836649	3836663	3836665	3836664
	MBC300	d3/4"-Rp1 1/4"	3836651	3836653	3836652	3836666	3836668	3836667

OTHER AVAILABLE VERSIONS

 Versions for continuous ventilation and post-ventilation

SCOPE OF SUPPLY

The burner is delivered in its package complete with:

- 1 burner head with flange seal and securing screws
- 1 compact gas train with gas filter; the gas filter is built-in for threaded valves (up to 2") and separated for flanged ones (DN65/80/100)
- 1 bag containing installation fittings
- 1 bag containing technical documentation (instruction manual, technical data, electrical diagram, exploded view and spare parts list)



DIMENSIONS (mm)

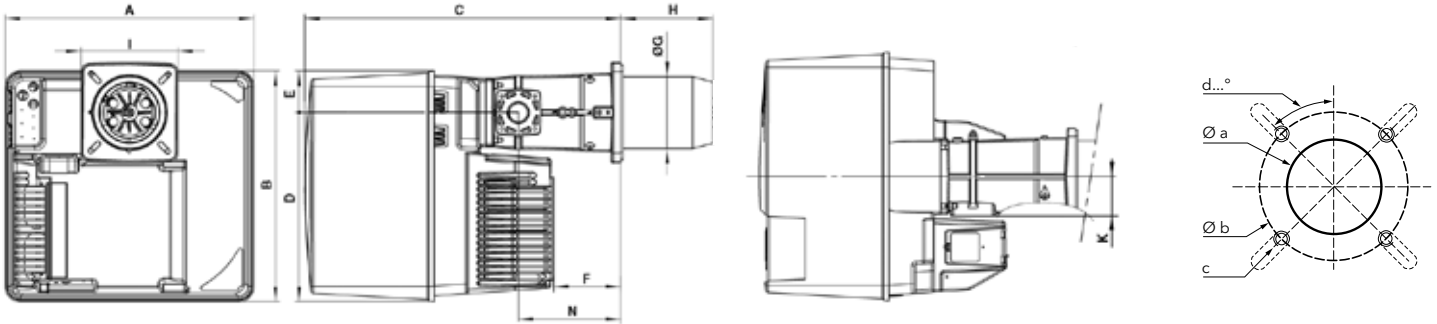

A	B	C	D	E	F	ØG	H			I	K	N
							KN	KM	KL			
581	549	752	450	99	164	170	215	325	435	230x238	89	244

Øa (mm)	b (mm)	c	d
195	220-260	M10	45°

Gas trains

Gas train "d":

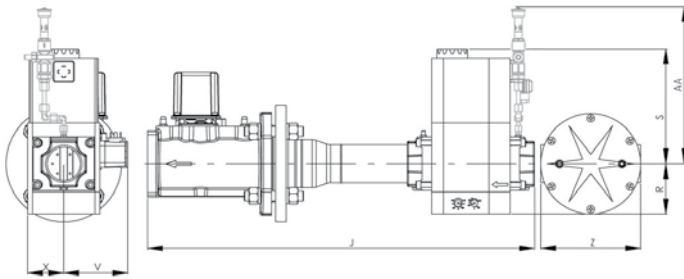

Model	J	R	S	V	X	Z	AA*
d65-DN65	490	183	245	110	98	290	385
d2"-Rp2"	700	96	330	125	81	-	385
d1"1/2-Rp2"	622	80	185	102	57	-	320
d3/4"-Rp1"1/4	460	60	173	88	58	-	320

Gas train "s":

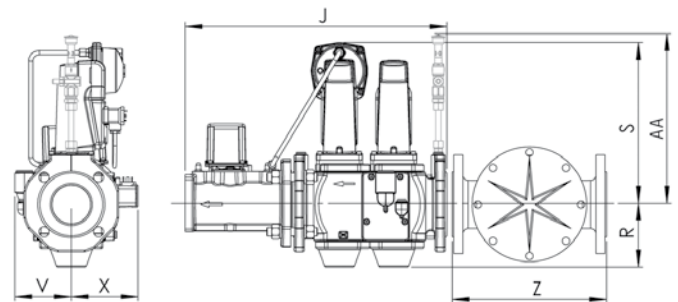

Model	J	R	S	V	X	Z	AA*
s65-DN65	490	118	300	106	126	290	365

*: for PED configuration

PACKAGING

The burner is delivered on a pallet in three packages containing:

- burner housing
- combustion head
- gas train and filter

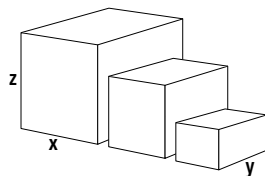

Component		Dimensions (mm)			Gross weight (kg)
		X	Y	Z	
Burner body	VG5.700 M	800	600	850	70
	VG5.1000 M	800	600	850	70
Combustion head	KN	780	265	280	13
	KL	1010	265	280	16
	KM	1010	265	280	15
Gas train	s65-DN65/TC	670	530	380	26
	d65-DN65/TC	670	530	380	17
	d2"-Rp2"/TC	670	530	380	12
	d1"1/2-Rp2"/TC	670	530	380	12
	d3/4"-Rp1"1/4/TC	600	400	240	7

VGL5.700 M / VGL5.1000 M

200 ... 1000 kW

Two stage progressive/modulating electronic in gas / Three stages in oil

PRESSURE LOSS [BURNER HEAD + GAS TRAIN] (mbar)

VGL5.700 M

Burner output (kW)	Natural gas G20 Hi = 10,35 kWh/m ³			Natural gas G25 Hi = 8,83 kWh/m ³			LPG G31 Hi = 25,89 kWh/m ³	
	d3/4-Rp1"1/4	d1"1/2-Rp2"	d2"-Rp2"	d3/4-Rp1"1/4	d1"1/2-Rp2"	d2"-Rp2"	d3/4-Rp1"1/4	d1"1/2-Rp2"
400	20	7	4	30	10	7	10	5
500	31	10	6	46	15	10	16	8
600	44	15	9	67	21	14	24	11
700	-	20	12	90	30	19	32	15

Natural gas G20

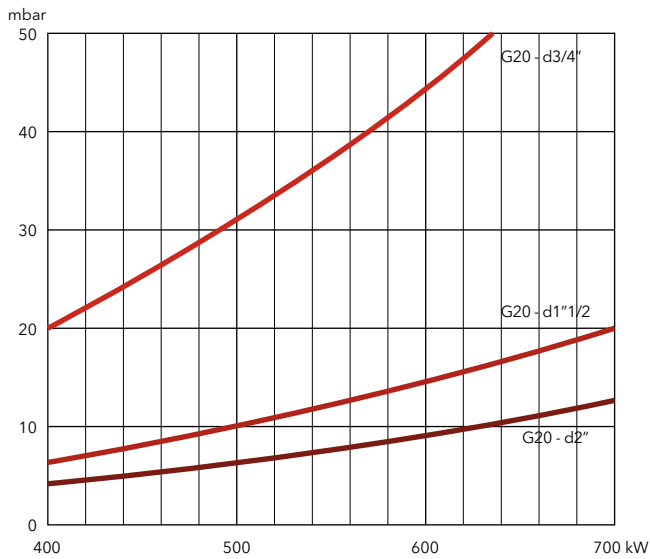

Natural gas G25

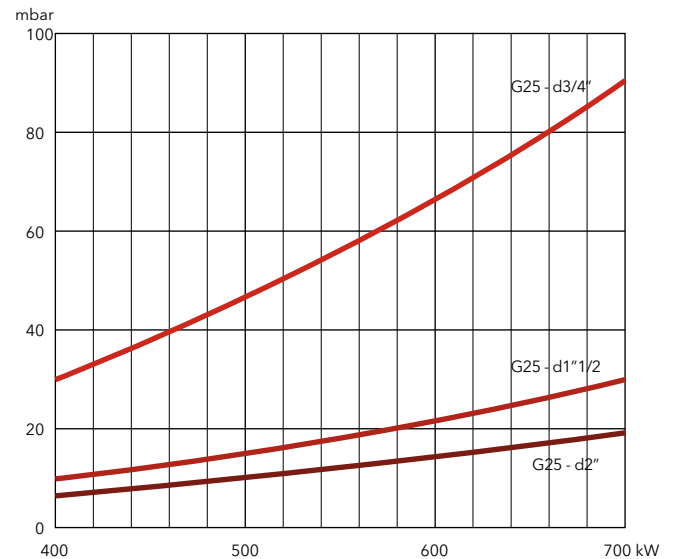

LPG

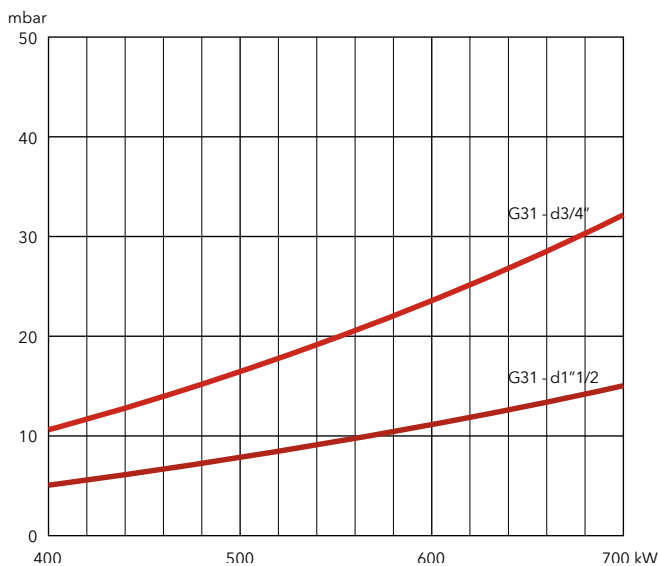



PRESSURE LOSS [BURNER HEAD + GAS TRAIN] (mbar)

VGL5.1000 M

Burner output (kW)	Natural gas G20 Hi = 10,35 kWh/m ³					Natural gas G25 Hi = 8,83 kWh/m ³					LPG G31
	d3/4-Rp1"1/4	d1"1/2-Rp2"	d2"-Rp2"	d65-DN65	s65-DN65	d3/4-Rp1"1/4	d1"1/2-Rp2"	d2"-Rp2"	d65-DN65	s65-DN65	d1"1/2-Rp2"
600	42	12	7	6	6	63	18	10	9	9	8
700	57	16	10	8	8	86	25	14	12	12	10
800	75	22	12	10	11	112	32	19	16	16	14
900	95	27	16	13	14	141	41	24	20	21	17
1000	117	34	20	16	17	175	50	29	24	26	21

Natural gas G20

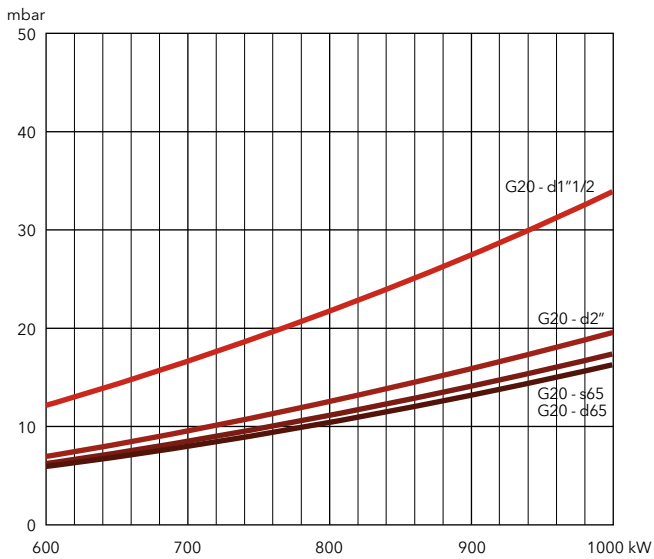

Natural gas G25

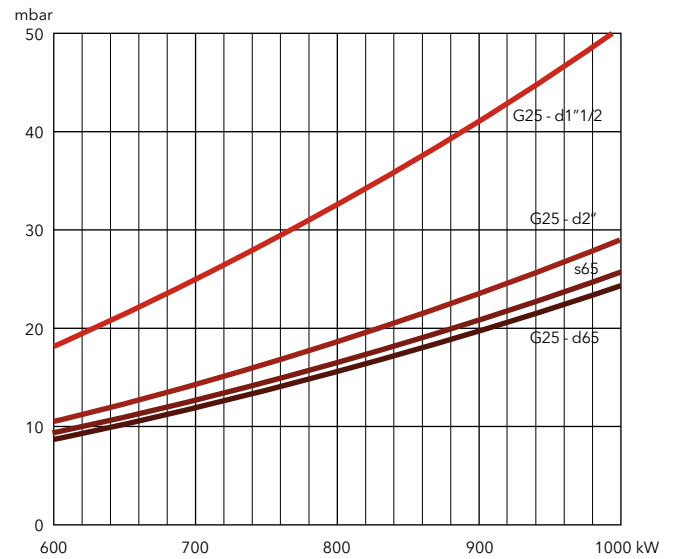

Natural gas G20, G25

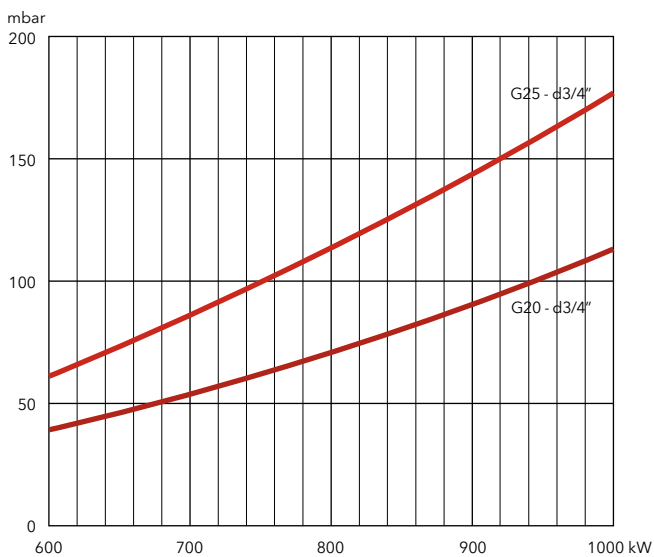

LPG

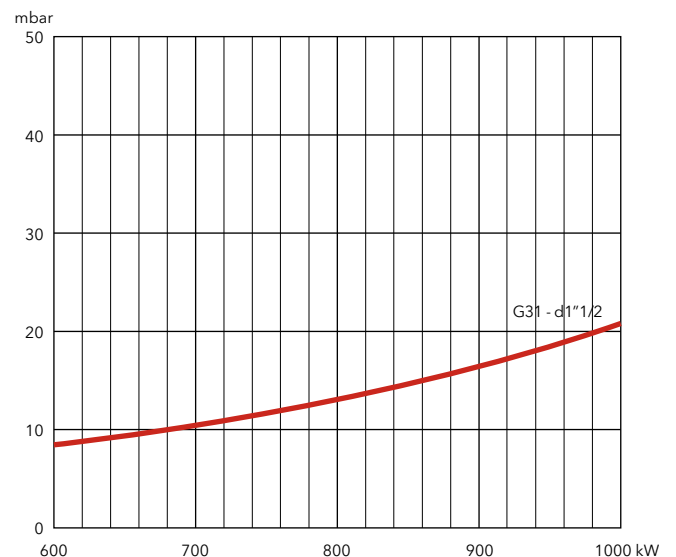

VGL6.1600 M / VGL6.2100 M

300 ... 2050 kW

Two stage progressive/modulating electronic in gas / Three stages in oil



- **Fuels:** natural gas (G20/G25, $H_u = 8,83 \dots 10,35 \text{ kWh/m}^3$);
light oil (viscosity $6 \text{ mm}^2/\text{s}$ at 20°C , $H_u = 11,86 \text{ kWh/kg}$)
- **Emissions:** Low NOx class 3 in gas ($\leq 80 \text{ mg/kWh}$) according to EN676
Low NOx class 2 in light oil ($\leq 185 \text{ mg/kWh}$) according to EN267
- **Operation:** two stage progressive or modulating with the installation of a power regulator and dedicated probes (see page 218) in gas and three stages in light oil
- **Protection level:** IP 41

TECHNICAL DATA

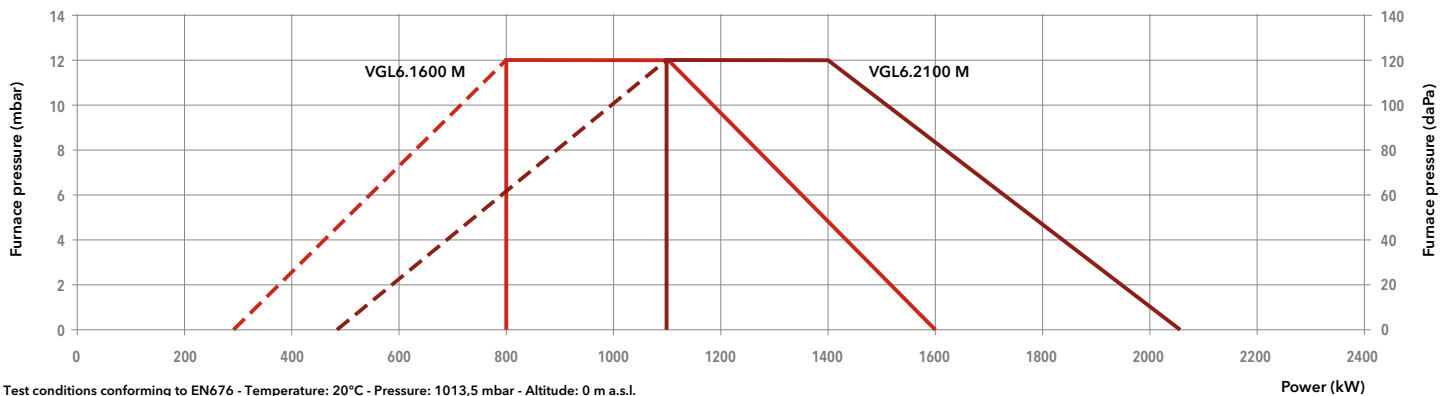

Model	VGL6.1600 M /TC			VGL6.2100 M /TC				
Operation range	(300) 800 - 1600 kW			(480) 1100 - 2050 kW				
Gas pressure	20 - 300 mbar			20 - 300 mbar				
Control box / flame detection	BT3... / QRA 2			BT3... / QRA 2				
Fan motor	230/400 V - 50 Hz - 2,2 kW			230/400 V - 50 Hz - 2,5 kW				
Electrical consumption	2800 W			3400 W				
Acoustic level (LpA)	77,2 dB(A)			79 dB(A)				
CE certificate	1312 BM 3427			1312 BM 3428				
Head length		KN	KL	KM	KN	KL	KM	
Complete	VGD 40-065	s65-DN65/TC	3836669	3836671	3836670	3836681	3836683	3836682
burner code	MBC1900	d65-DN65/TC	3836672	3836674	3836673	3836684	3836686	3836685
	MBC1200	d2"-Rp2"/TC	3836675	3836677	3836676	3836687	3836689	3836688
	MBC700	d1"1/2-Rp2"/TC	3836678	3836680	3836679	3836690	3836692	3836691

OTHER AVAILABLE VERSIONS

 Versions for continuous ventilation and post-ventilation

SCOPE OF SUPPLY

The burner is delivered in its package complete with:

- 1 burner head with flange seal and securing screws
- 1 compact gas train with gas filter; the gas filter is built-in for threaded valves (up to 2") and separated for flanged ones (DN65/80/100)
- 1 bag containing installation fittings
- 1 bag containing technical documentation (instruction manual, technical data, electrical diagram, exploded view and spare parts list)



DIMENSIONS (mm)

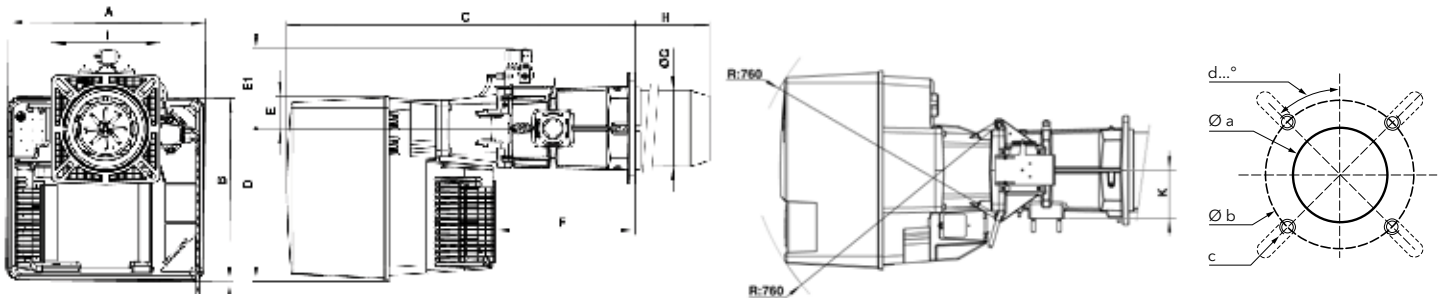

A	B	C	D	E	E1	F	ØG	H			I	K	N
								KN	KM	KL			
592	553	1050	456	97	239	421	227	270	370	470	326x335	144	247

Øa (mm)	b (mm)	c	d
250	300-400	M12	45°

Gas trains

Gas train "d":

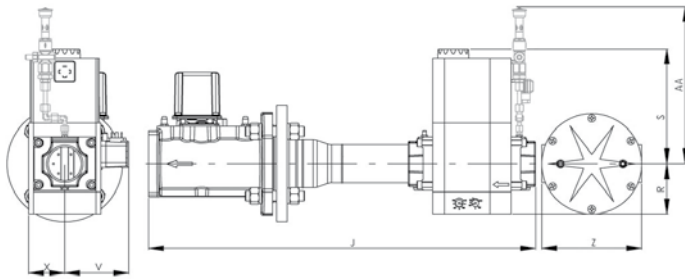

Model	J	R	S	V	X	Z	AA*
d65-DN65	490	183	245	110	98	290	385
d2"-Rp2"	700	96	330	125	81	-	385
d1"1/2-Rp2"	622	80	185	102	57	-	320

Gas train "s":

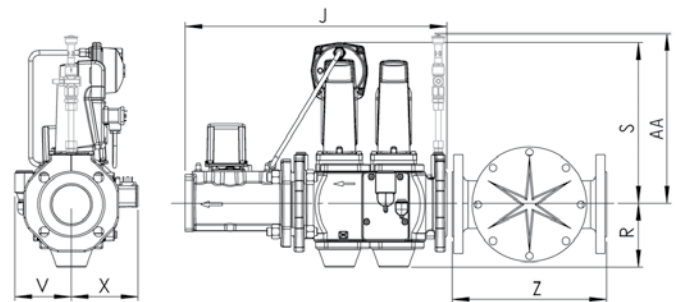

Model	J	R	S	V	X	Z	AA*
s65-DN65	490	118	300	106	126	290	365

*: for PED configuration

PACKAGING

The burner is delivered on a pallet in three packages containing:

- burner housing
- combustion head
- gas train and filter

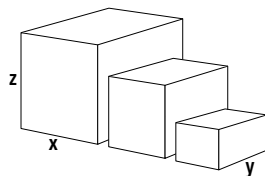

Component		Dimensions (mm)			Gross weight (kg)
		X	Y	Z	
Burner body	VGL6.1600 M	1200	800	1440	140
	VGL6.2100 M	1200	800	1440	140
Combustion head	KN	800	380	240	28
	KL	1000	380	420	30
	KM	1000	380	420	31
Gas train	s65-DN65/TC	790	600	500	29,4
	d65-DN65/TC	670	550	380	33
	d2"-Rp2"/TC	670	550	380	22
	d1"1/2-Rp2"/TC	670	550	380	21

VGL6.1600 M / VGL6.2100 M

300 ... 2050 kW

Two stage progressive/modulating electronic in gas / Three stages in oil

PRESSURE LOSS [BURNER HEAD + GAS TRAIN] (mbar)

VGL6.1600 M

Burner output (kW)	Natural gas G20 Hi = 10,35 kWh/m ³				Natural gas G25 Hi = 8,83 kWh/m ³				LPG G31 Hi = 25,89 kWh/m ³
	d1"1/2-Rp2"	d2"-Rp2"	d65-DN65	s65-DN65	d1"1/2-Rp2"	d2"-Rp2"	d65-DN65	s65-DN65	d1"1/2-Rp2"
800	16	9	6	6	22	12	8	8	8
1000	25	13	10	9	34	18	12	12	12
1200	35	18	14	13	48	24	18	18	17
1400	47	24	19	18	64	32	24	24	22
1600	61	31	25	23	83	42	31	31	29

Natural gas G20

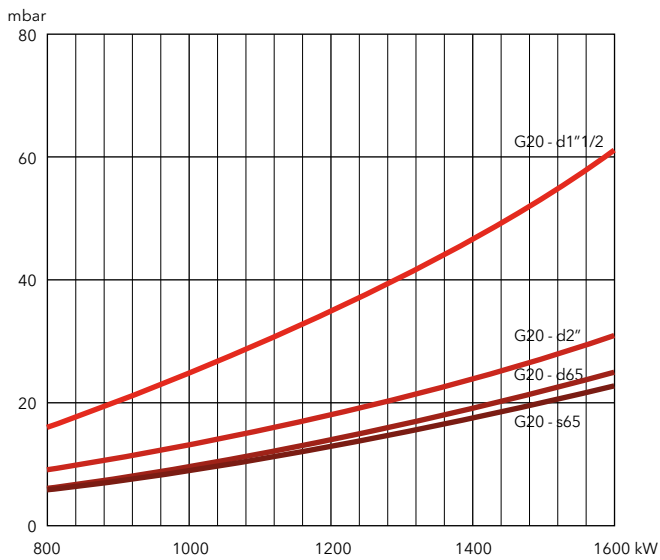

Natural gas G25

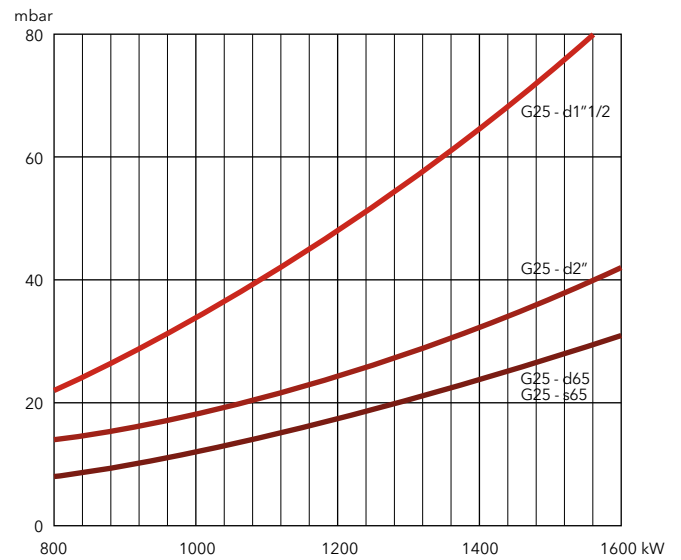

LPG

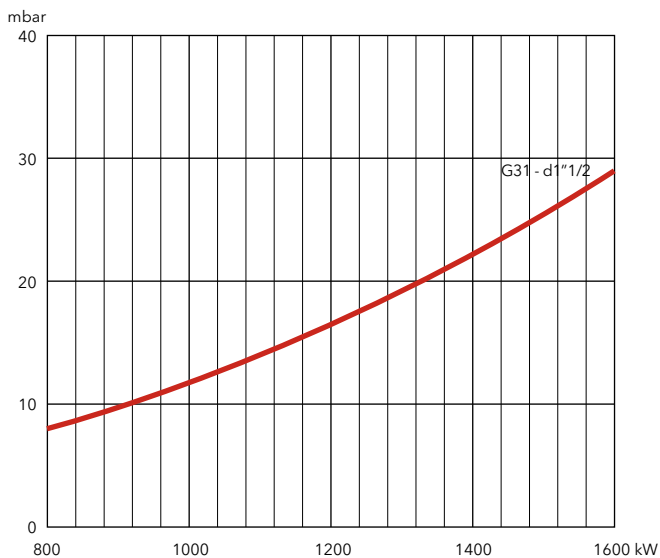



PRESSURE LOSS [BURNER HEAD + GAS TRAIN] (mbar)

VGL6.2100 M

Burner output (kW)	Natural gas G20 Hi = 10,35 kWh/m ³				Natural gas G25 Hi = 8,83 kWh/m ³				LPG G31 Hi = 25,89 kWh/m ³	
	d1"1/2-Rp2"	d2"-Rp2"	d65-DN65	s65-DN65	d1"1/2-Rp2"	d2"-Rp2"	d65-DN65	s65-DN65	d1"1/2-Rp2"	d2"-Rp2"
1100	28	15	12	11	39	21	15	15	13	9
1300	39	21	16	16	54	29	21	22	18	11
1500	51	27	21	21	71	37	28	29	23	14
1700	64	34	27	27	91	47	36	37	29	17
1900	80	41	34	34	114	59	45	46	36	20

Natural gas G20

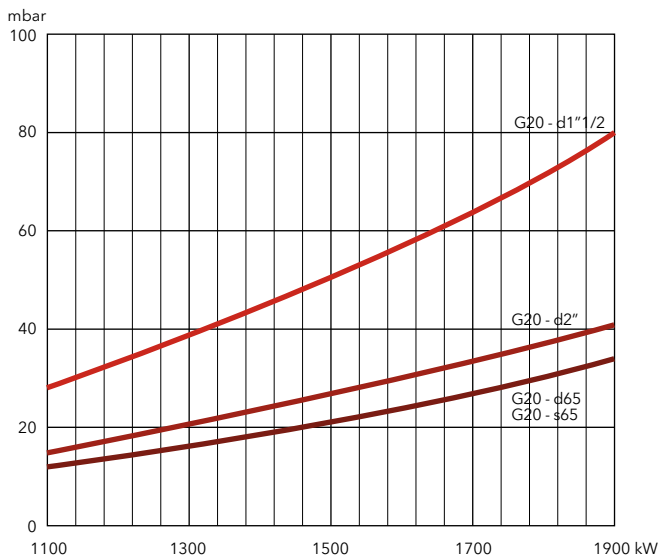

Natural gas G25

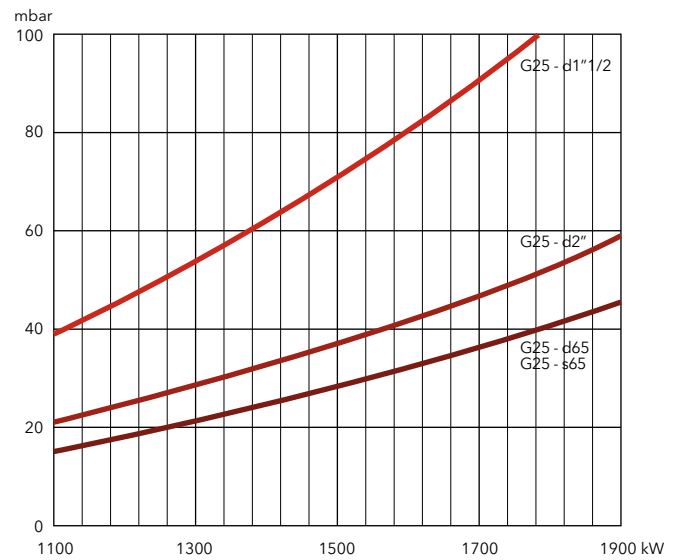

LPG

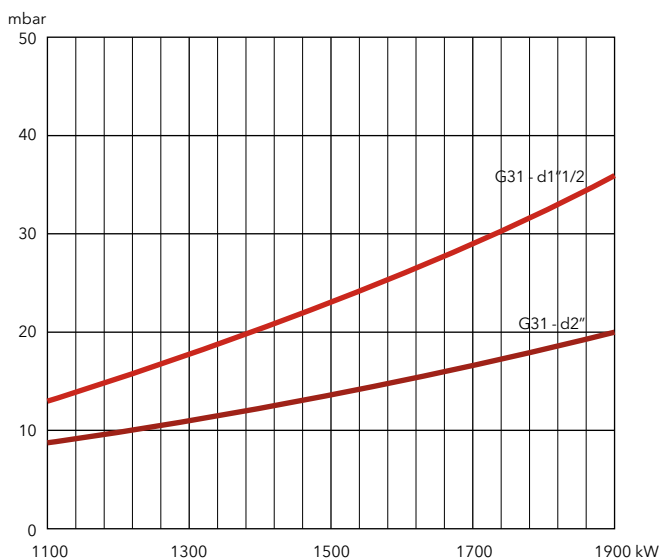

VGL5.700 M V / VGL5.1000 M V

200 ... 1000 kW

Two stage progressive/modulating electronic / Three stages + fan speed control

- **Fuels:** natural gas (G20/G25, $H_u = 8,83...10,35 \text{ kWh/m}^3$);
light oil (viscosity $6 \text{ mm}^2/\text{s}$ at 20°C , $H_u = 11,86 \text{ kWh/kg}$)
- **Emissions:** Low NOx class 3 in gas ($\leq 80 \text{ mg/kWh}$) according to EN676
Low NOx class 2 in light oil ($\leq 185 \text{ mg/kWh}$) according to EN267
- **Operation:** two stage progressive or modulating with the installation of a power regulator and dedicated probes (see page 218) in gas and three stages in light oil
- **Protection level:** IP 41



TECHNICAL DATA

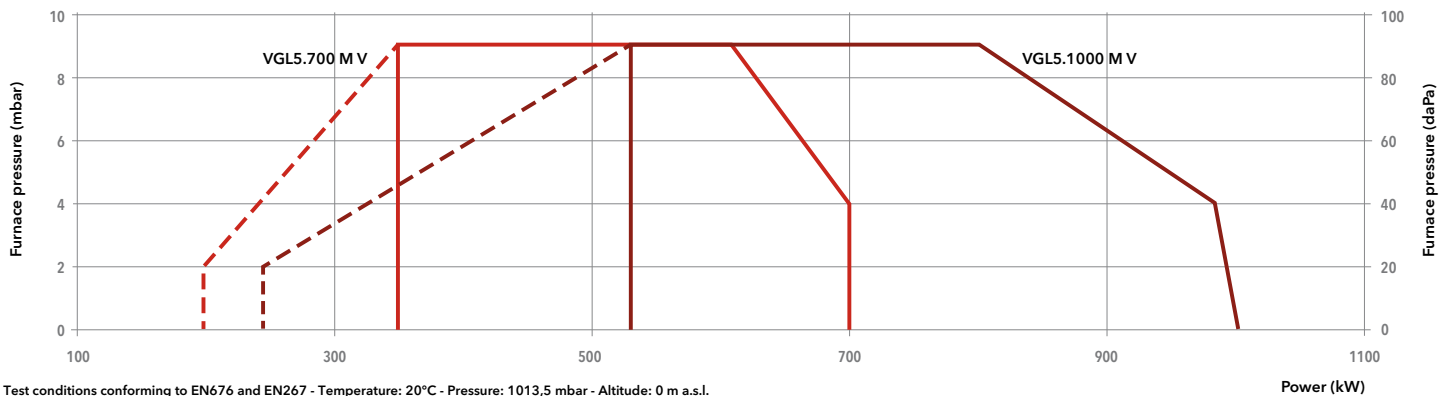

Test conditions conforming to EN676 and EN267 - Temperature: 20°C - Pressure: 1013,5 mbar - Altitude: 0 m a.s.l.

Model	VGL5.700 M V /TC			VGL5.1000 M V /TC				
Operation range	(200) 350 – 700 kW			(240) 530 – 1000 kW				
Gas pressure	20 – 300 mbar			20 – 300 mbar				
Control box / flame detection	BT3... / QRA 2			BT3... / QRA 2				
Fan motor	230/400 V – 50 Hz – 1,1 kW			230/400 V – 50 Hz – 1,5 kW				
Nozzle	4,5 US gal/h 45°B / 5 US gal/h 45°B			5 US gal/h 45°B / 8,5 US gal/h 45°B				
Electrical consumption	2000 W			2200 W				
Acoustic level (LpA)	78 dB(A)			81 dB(A)				
CE certificate	1312 AQ 924			1312 AQ 925				
Head length		KN	KL	KM	KN	KL	KM	
Complete burner code	VDG 40-065	s65-DN65	-	-	-	3836702	3836704	3836703
	MBC1900	d65-DN65	-	-	-	3836705	3836707	3836706
	MBC1200	d2"-Rp2"	3836693	3836695	3836694	3836708	3836710	3836709
	MBC700	d1 1/2"-Rp2"	3836696	3836698	3836697	3836711	3836713	3836712
	MBC300	d3/4"-Rp1 1/4"	3836699	3836701	3836700	3836714	3836716	3836715

OTHER AVAILABLE VERSIONS

 Versions for continuous ventilation and post-ventilation

SCOPE OF SUPPLY

The burner is delivered in its package complete with:

- 1 burner head with flange seal and securing screws
- 1 compact gas train with gas filter; the gas filter is built-in for threaded valves (up to 2") and separated for flanged ones (DN65/80/100)
- 1 bag containing installation fittings
- 1 bag containing technical documentation (instruction manual, technical data, electrical diagram, exploded view and spare parts list)



DIMENSIONS (mm)

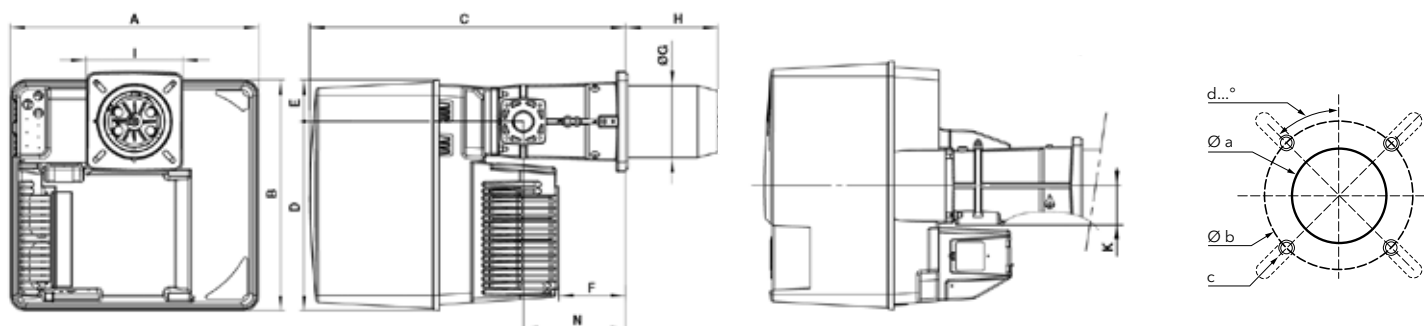

A	B	C	D	E	F	ØG	H			I	K	N
							KN	KM	KL			
581	549	752	450	99	164	170	215	325	435	230x238	89	244

Øa (mm)	b (mm)	c	d
195	220-260	M10	45°

Gas trains

Gas train "d":

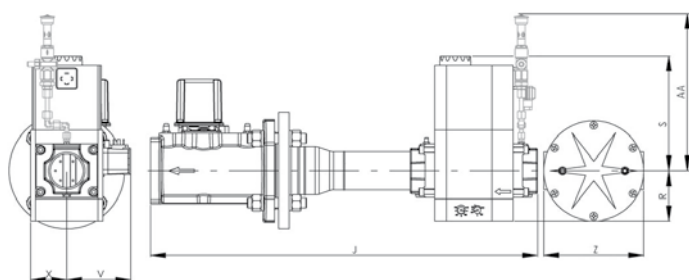

Model	J	R	S	V	X	Z	AA*
d65-DN65	490	183	245	110	98	290	385
d2"-Rp2"	700	96	330	125	81	-	385
d1"1/2-Rp2"	622	80	185	102	57	-	320
d3/4"-Rp1"1/4	460	60	173	88	58	-	320

Gas train "s":

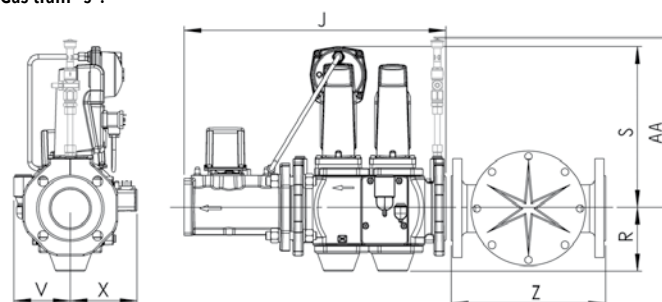

Model	J	R	S	V	X	Z	AA*
s65-DN65	490	118	300	106	126	290	365

*: for PED configuration

PACKAGING

The burner is delivered on a pallet in three packages containing:

- burner housing
- combustion head
- gas train and filter

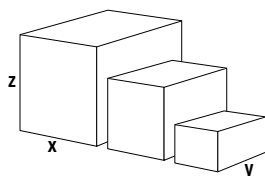

Component		Dimensions (mm)			Gross weight (kg)
		X	Y	Z	
Burner body	VGL5.700 M V	800	600	850	70
	VGL5.1000 M V	800	600	850	70
Combustion head	KN	780	265	280	13
	KL	1010	265	280	16
	KM	1010	265	280	15
Gas train	s65-DN65/TC	670	530	380	26
	d65-DN65/TC	670	530	380	17
	d2"-Rp2"/TC	670	530	380	12
	d1"1/2-Rp2"/TC	670	530	380	12
	d3/4"-Rp1"1/4/TC	600	400	240	7

VGL5.700 M V / VGL5.1000 M V

200 ... 1000 kW

Two stage progressive/modulating electronic / Three stages + fan speed control

PRESSURE LOSS [BURNER HEAD + GAS TRAIN] (mbar)

VGL5.700 M V

Burner output (kW)	Natural gas G20 Hi = 10,35 kWh/m ³			Natural gas G25 Hi = 8,83 kWh/m ³			LPG G31 Hi = 25,89 kWh/m ³	
	d3/4-Rp1"1/4	d1"1/2-Rp2"	d2"-Rp2"	d3/4-Rp1"1/4	d1"1/2-Rp2"	d2"-Rp2"	d3/4-Rp1"1/4	d1"1/2-Rp2"
400	20	7	4	30	10	7	10	5
500	31	10	6	46	15	10	16	8
600	44	15	9	67	21	14	24	11
700	-	20	12	90	30	19	32	15

Natural gas G20

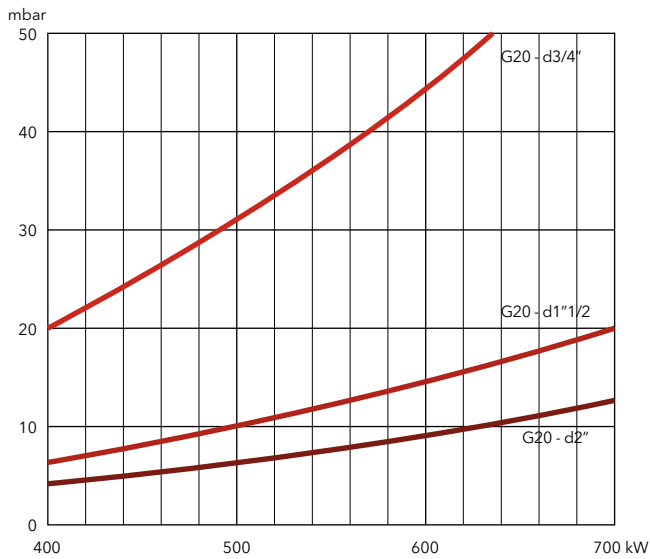

Natural gas G25

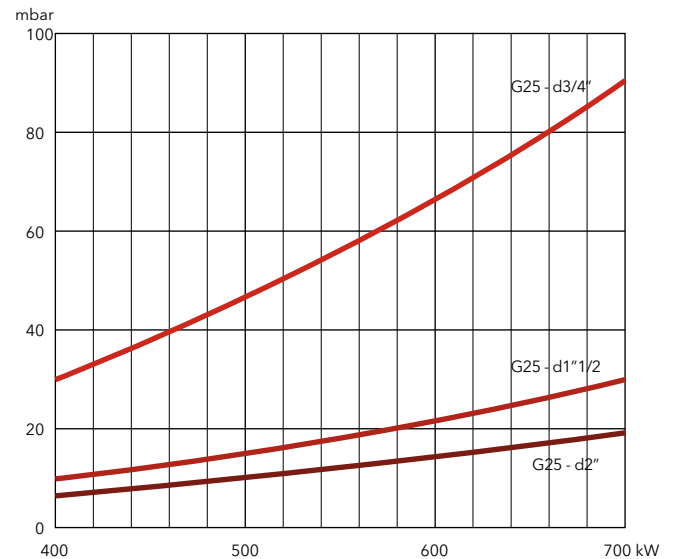

LPG

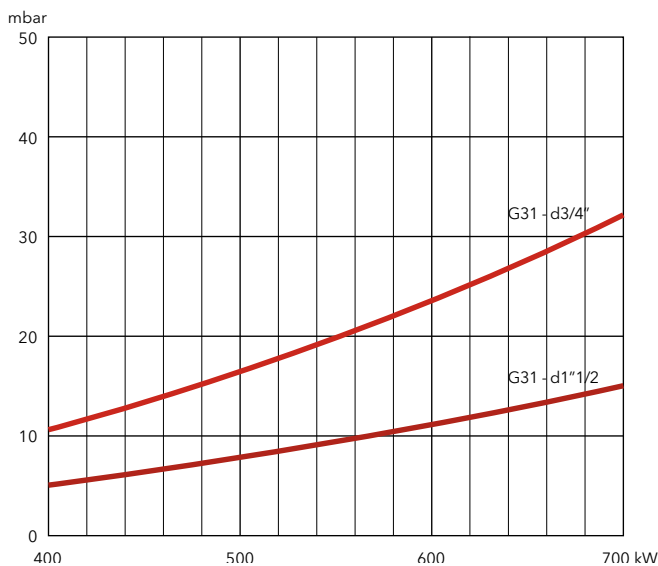



PRESSURE LOSS [BURNER HEAD + GAS TRAIN] (mbar)

VGL5.1000 M V

Burner output (kW)	Natural gas G20 Hi = 10,35 kWh/m ³					Natural gas G25 Hi = 8,83 kWh/m ³					LPG G31
	d3/4-Rp1"1/4	d1"1/2-Rp2"	d2"-Rp2"	d65-DN65	s65-DN65	d3/4-Rp1"1/4	d1"1/2-Rp2"	d2"-Rp2"	d65-DN65	s65-DN65	d1"1/2-Rp2"
600	42	12	7	6	6	63	18	10	9	9	8
700	57	16	10	8	8	86	25	14	12	12	10
800	75	22	12	10	11	112	32	19	16	16	14
900	95	27	16	13	14	141	41	24	20	21	17
1000	117	34	20	16	17	175	50	29	24	26	21

Natural gas G20

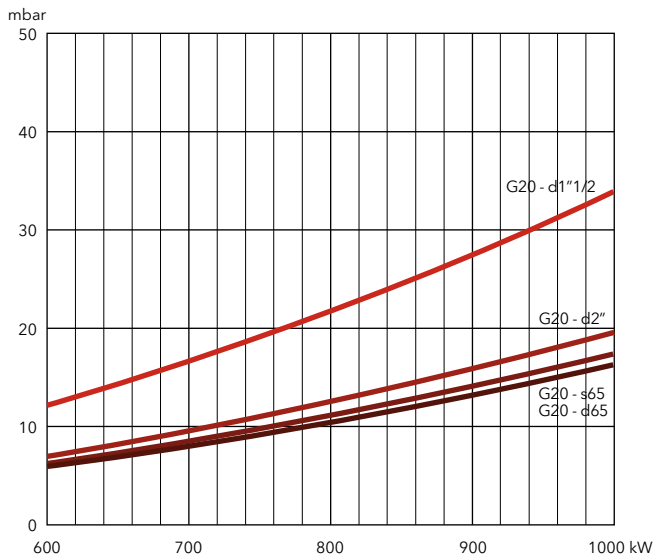

Natural gas G25

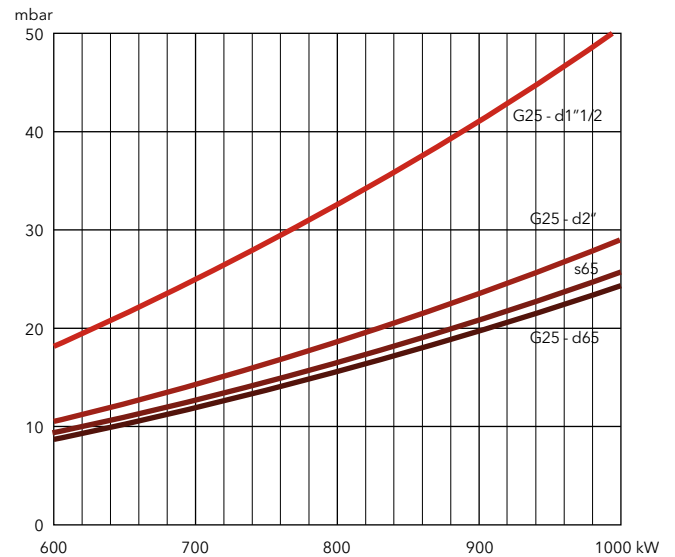

Natural gas G20, G25

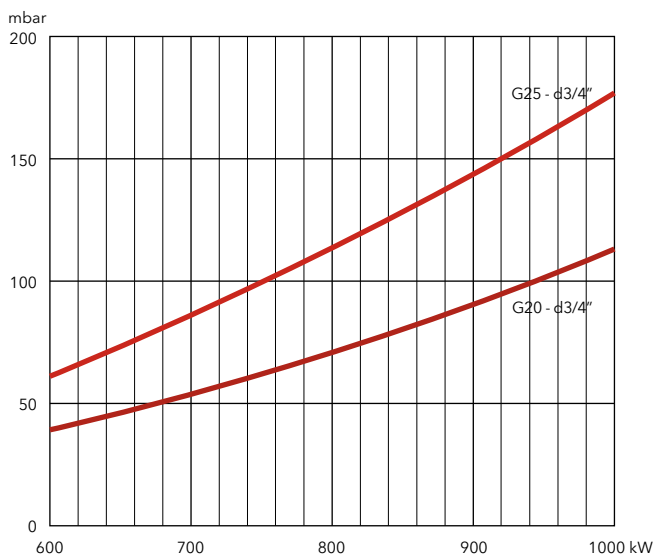

LPG

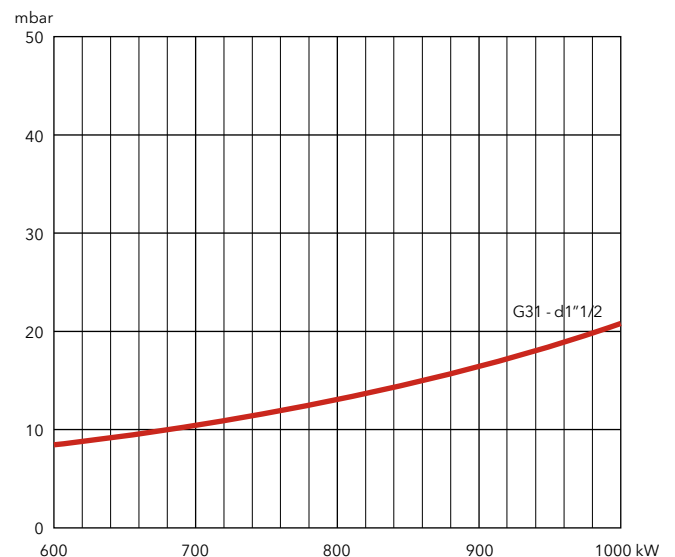

VGL6.1600 M V / VGL6.2100 M V

300 ... 2050 kW

Two stage progressive/modulating electronic / Three stages + fan speed control

- **Fuels:** natural gas (G20/G25, $H_u = 8,83...10,35 \text{ kWh/m}^3$);
light oil (viscosity $6 \text{ mm}^2/\text{s}$ at 20°C , $H_u = 11,86 \text{ kWh/kg}$)
- **Emissions:** Low NOx class 3 in gas ($\leq 80 \text{ mg/kWh}$) according to EN676
Low NOx class 2 in light oil ($\leq 185 \text{ mg/kWh}$) according to EN267
- **Operation:** two stage progressive or modulating with the installation of a power regulator and dedicated probes (see page 218) in gas and three stages in light oil
- **Protection level:** IP 41



TECHNICAL DATA

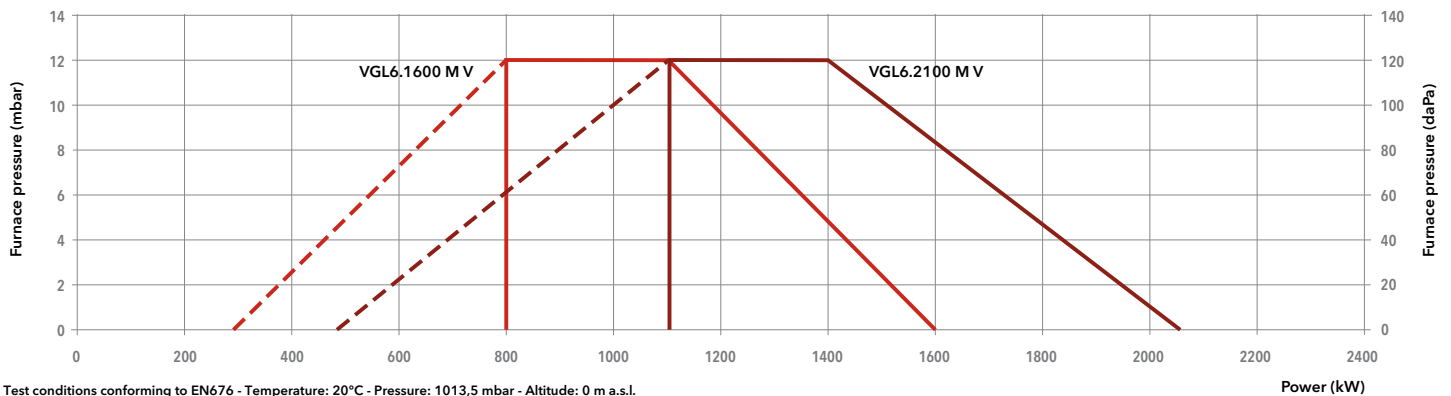

Test conditions conforming to EN676 - Temperature: 20°C - Pressure: 1013,5 mbar - Altitude: 0 m a.s.l.

Model	VGL6.1600 M V /TC			VGL6.2100 M V /TC			
Operation range	(300) 800 - 1600 kW			(480) 1100 - 2050 kW			
Gas pressure	20 - 300 mbar			20 - 300 mbar			
Control box / flame detection	BT3... / QRA 2			BT3... / QRA 2			
Fan motor	230/400 V - 50 Hz - 2,2 kW			230/400 V - 50 Hz - 2,5 kW			
Electrical consumption	2800 W			3400 W			
Acoustic level (LpA)	77,2 dB(A)			79 dB(A)			
CE certificate	1312 BM 3427			1312 BM 3428			
Head length	KN	KL	KM	KN	KL	KM	
Complete	VGD 40-065 s65-DN65/TC	3836717	3836719	3836718	3836729	3836731	3836730
burner code	MBC1900 d65-DN65/TC	3836720	3836722	3836721	3836732	3836734	3836733
	MBC1200 d2"-Rp2"/TC	3836723	3836725	3836724	3836735	3836737	3836736
	MBC700 d1"1/2-Rp2"/TC	3836726	3836728	3836727	3836738	3836740	3836739

OTHER AVAILABLE VERSIONS

 Versions for continuous ventilation and post-ventilation

SCOPE OF SUPPLY

The burner is delivered in its package complete with:

- 1 burner head with flange seal and securing screws
- 1 compact gas train with gas filter; the gas filter is built-in for threaded valves (up to 2") and separated for flanged ones (DN65/80/100)
- 1 bag containing installation fittings
- 1 bag containing technical documentation (instruction manual, technical data, electrical diagram, exploded view and spare parts list)



DIMENSIONS (mm)

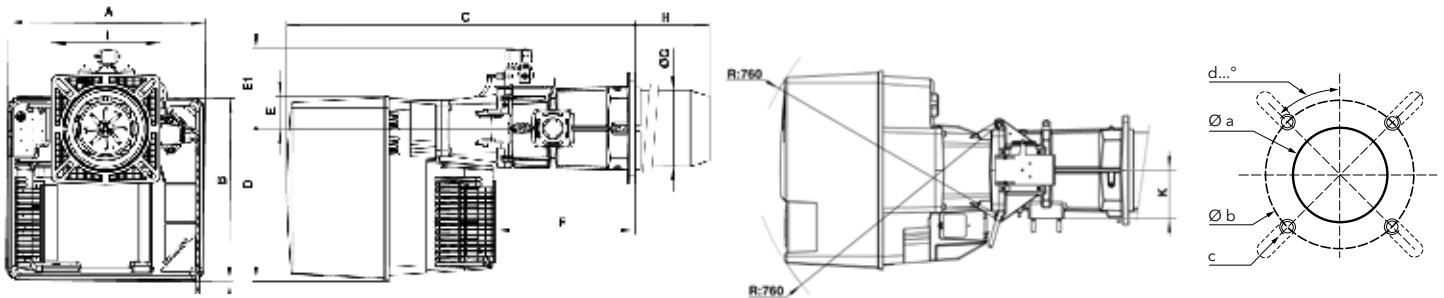

A	B	C	D	E	E1	F	ØG	H			I	K	N
								KN	KM	KL			
592	553	1050	456	97	239	421	227	270	370	470	326x335	144	247

Øa (mm)	b (mm)	c	d
250	300-400	M12	45°

Gas trains

Gas train "d":

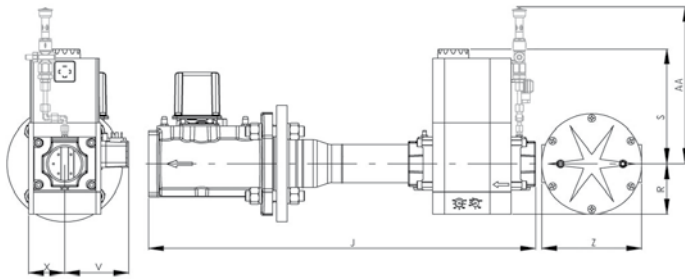

Model	J	R	S	V	X	Z	AA*
d65-DN65	490	183	245	110	98	290	385
d2"-Rp2"	700	96	330	125	81	-	385
d1"1/2-Rp2"	622	80	185	102	57	-	320

Gas train "s":

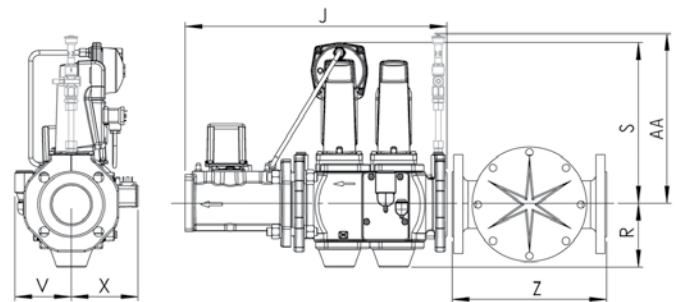

Model	J	R	S	V	X	Z	AA*
s65-DN65	490	118	300	106	126	290	365

*: for PED configuration

PACKAGING

The burner is delivered on a pallet in three packages containing:

- burner housing
- combustion head
- gas train and filter

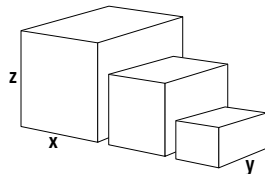

Component		Dimensions (mm)			Gross weight (kg)
		X	Y	Z	
Burner body	VGL6.1600 M V	1200	800	1440	140
	VGL6.2100 M V	1200	800	1440	140
Combustion head	KN	800	380	240	28
	KL	1000	380	420	30
	KM	1000	380	420	31
Gas train	s65-DN65/TC	670	530	380	26
	d65-DN65/TC	670	530	380	17
	d2"-Rp2"/TC	670	530	380	12
	d1"1/2-Rp2"/TC	670	530	380	12

VGL6.1600 M V / VGL6.2100 M V

300 ... 2050 kW

Two stage progressive/modulating electronic / Three stages + fan speed control

PRESSURE LOSS [BURNER HEAD + GAS TRAIN] (mbar)

VGL6.1600 M V

Burner output (kW)	Natural gas G20 Hi = 10,35 kWh/m ³				Natural gas G25 Hi = 8,83 kWh/m ³				LPG G31 Hi = 25,89 kWh/m ³
	d1"1/2-Rp2"	d2"-Rp2"	d65-DN65	s65-DN65	d1"1/2-Rp2"	d2"-Rp2"	d65-DN65	s65-DN65	d1"1/2-Rp2"
800	16	9	6	6	22	12	8	8	8
1000	25	13	10	9	34	18	12	12	12
1200	35	18	14	13	48	24	18	18	17
1400	47	24	19	18	64	32	24	24	22
1600	61	31	25	23	83	42	31	31	29

Natural gas G20

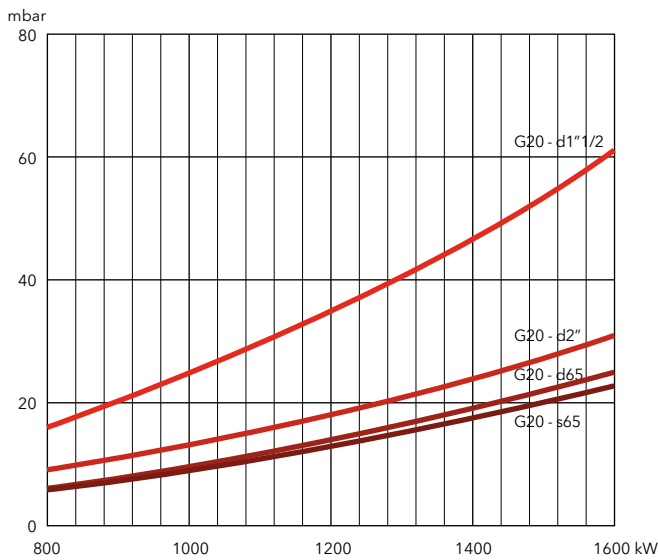

Natural gas G25

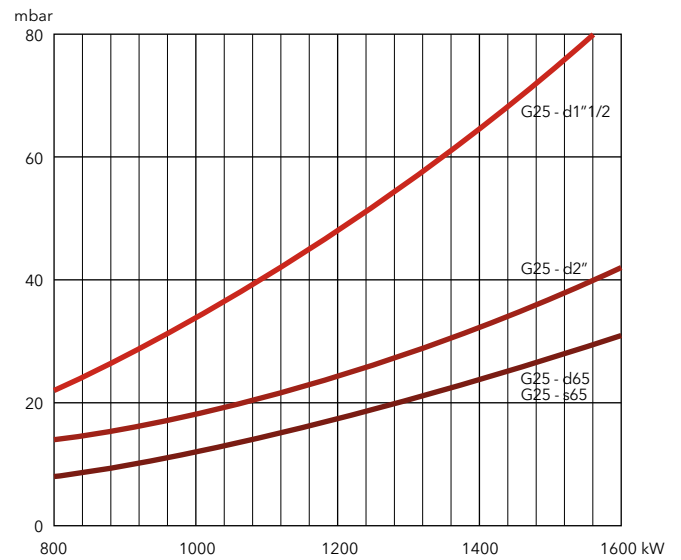

LPG

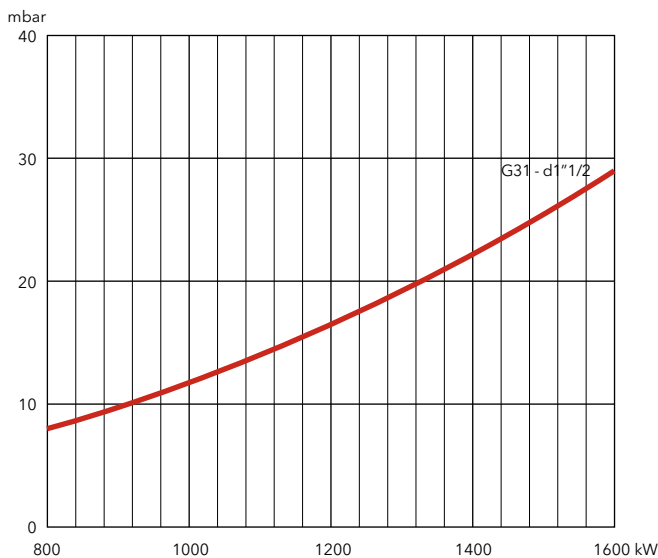



PRESSURE LOSS [BURNER HEAD + GAS TRAIN] (mbar)

VGL6.2100 M V

Burner output (kW)	Natural gas G20 Hi = 10,35 kWh/m ³				Natural gas G25 Hi = 8,83 kWh/m ³				LPG G31 Hi = 25,89 kWh/m ³	
	d1"1/2-Rp2"	d2"-Rp2"	d65-DN65	s65-DN65	d1"1/2-Rp2"	d2"-Rp2"	d65-DN65	s65-DN65	d1"1/2-Rp2"	d2"-Rp2"
1100	28	15	12	11	39	21	15	15	13	9
1300	39	21	16	16	54	29	21	22	18	11
1500	51	27	21	21	71	37	28	29	23	14
1700	64	34	27	27	91	47	36	37	29	17
1900	80	41	34	34	114	59	45	46	36	20

Natural gas G20

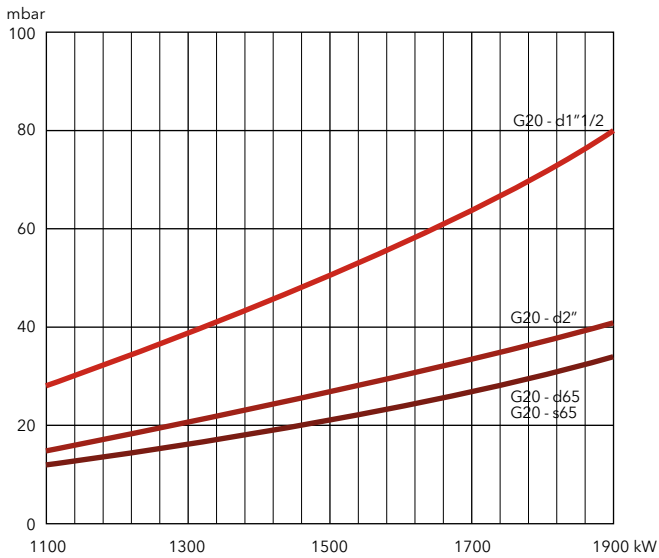

Natural gas G25

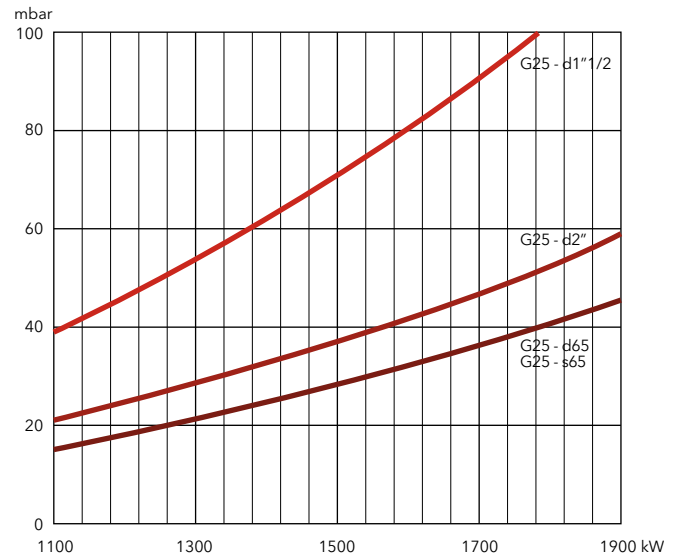

LPG

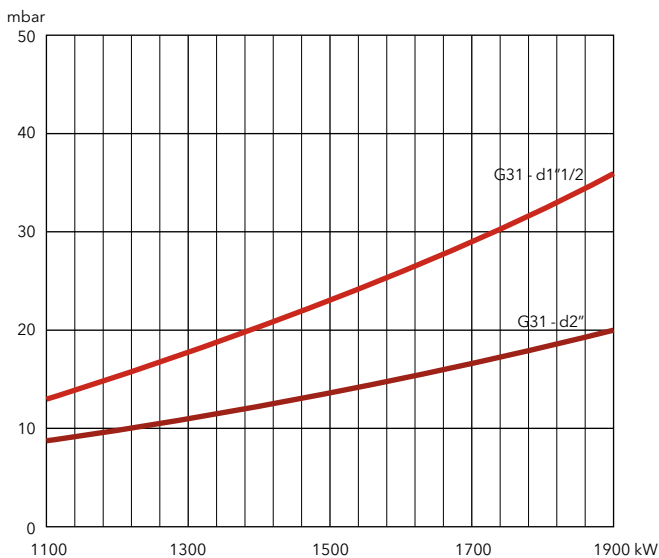

VE1.34 / VE1.50 / VE1.75

16 ... 75 kW
One stage (Yellow Flame)

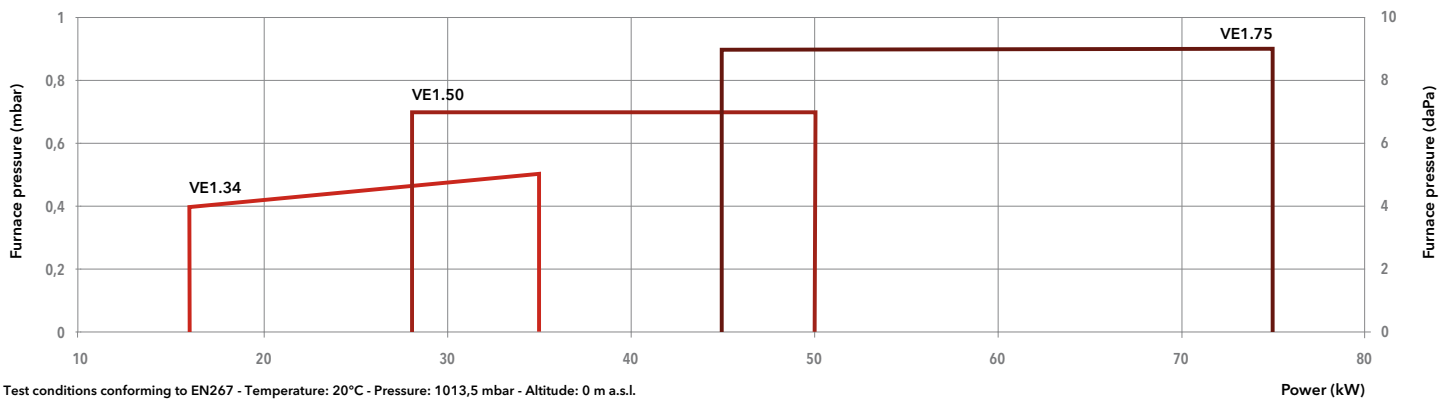

- **Fuel:** light oil (viscosity 6 mm²/s at 20°C, H_v = 11,86 kWh/kg)
- **Emissions:** NO_x < 100 mg/kWh (NCV), burners compliant with ErP Directive
- **Protection level:** IP 21

TECHNICAL DATA

Model	VE1.34	VE1.50	VE1.75
Operation range	16 - 34 kW	28 - 50 kW	44 - 75 kW
Fuel flow	1,3 - 2,8 kg/h	2,4 - 4,2 kg/h	3,7 - 6,3 kg/h
Nozzle	0,45 US gal/h 45°S	0,75 US gal/h 45°S	1,10 US gal/h 45°H
Control box / flame detection	TCH1... / QRB1	TCH1... / QRB1	TCH1... / QRB1
Fan motor	230 V - 50 Hz - 110 W	230 V - 50 Hz - 110 W	230 V - 50 Hz - 110 W
Electrical consumption	244 W	244 W	233 W
Flexible hoses	Rp 3/8" / M14 x 1,5 - 1000 mm	Rp 3/8" / M14 x 1,5 - 1000 mm	Rp 3/8" / M14 x 1,5 - 1000 mm
Acoustic level (LpA)	56 dB(A)	56 dB(A)	56 dB(A)
Head length	KN	KN	KN
Complete burner code	3832630	3832632	3832634

OTHER AVAILABLE VERSIONS

 Versions for continuous ventilation and post-ventilation

SCOPE OF SUPPLY

The burner is delivered in its package complete with:

- 1 setting template
- 1 burner flange with insulation
- 1 bag containing installation fittings
- 1 bag containing technical documentation (instruction manual, technical data, electrical diagram, exploded view and spare parts list)



DIMENSIONS (mm)

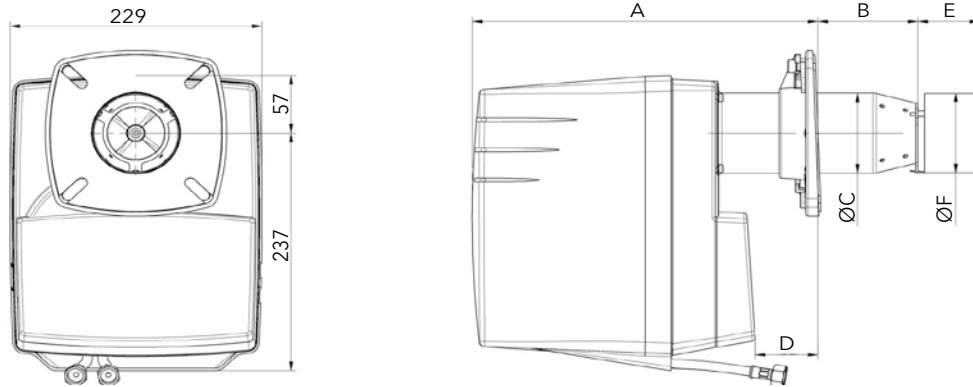

Model	A	B	ØC	D	E	ØF
VE1.34	264 ... 329	70 ... 135	80	12 ... 77	63	79
VE1.50	264 ... 344	70 ... 150	90	12 ... 92	56	84
VE1.75	297 ... 357	70 ... 138	90	15 ... 83	56	84

Connecting flange

Øa (mm)	b (mm)	c	d
95-104	150-170	M8	45°

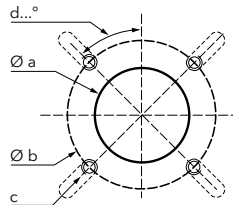

PACKAGING

The burner is delivered in a single package containing all the components

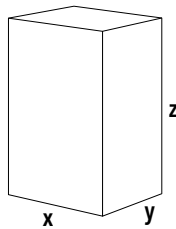

Burner	Dimensions (mm)			Gross weight (kg)
	X	Y	Z	
VE1.34	300	260	650	11
VE1.50	300	260	650	11
VE1.75	300	260	650	12

VE2.100 D / VE2.150 D

50 ... 150 kW
Two stages (Yellow Flame)

- **Fuel:** light oil (viscosity 6 mm²/s at 20°C, H_v = 11,86 kWh/kg)
- **Emissions:** NO_x < 100 mg/kWh (NCV), burners compliant with ErP Directive
- **Protection level:** IP 21

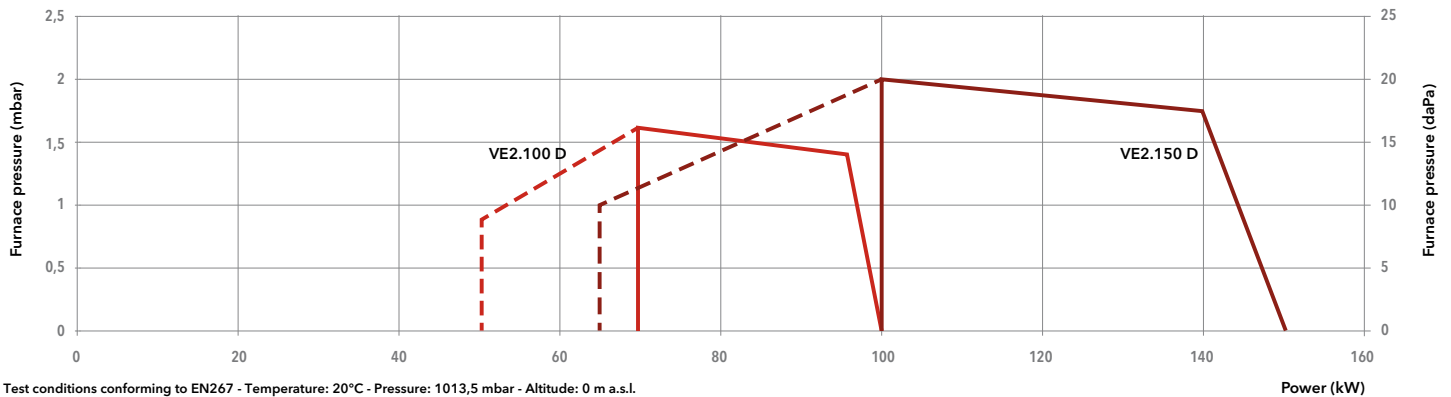
**TECHNICAL DATA**

Model	VE2.100 D	VE2.150 D
Operation range	(50) 70 - 100 kW	(65) 100 - 150 kW
Fuel flow	(4,2) 5,9 - 8,4 kg/h	(5,5) 8,4 - 12,6 kg/h
Nozzle	1,25 US gal/h 45°H	2,00 US gal/h 45°H
Control box / flame detection	TCH2... / FTEB	TCH2... / FTEB
Fan motor	230 V - 50 Hz - 130 W	230 V - 50 Hz - 130 W
Electrical consumption	325 W	325 W
Flexible hoses	Rp 3/8" / DN6 x 1,5 - 1500 mm	Rp 3/8" / DN6 x 1,5 - 1500 mm
Acoustic level (LpA)	66,5 dB(A)	66,5 dB(A)
Head length	KL	KL
Complete burner code	3833101	3833102

OTHER AVAILABLE VERSIONS

 Versions for continuous ventilation and post-ventilation

SCOPE OF SUPPLY

The burner is delivered in its package complete with:

- 1 setting template
- 1 burner flange with insulation
- 1 bag containing installation fittings
- 1 bag containing technical documentation (instruction manual, technical data, electrical diagram, exploded view and spare parts list)



DIMENSIONS (mm)

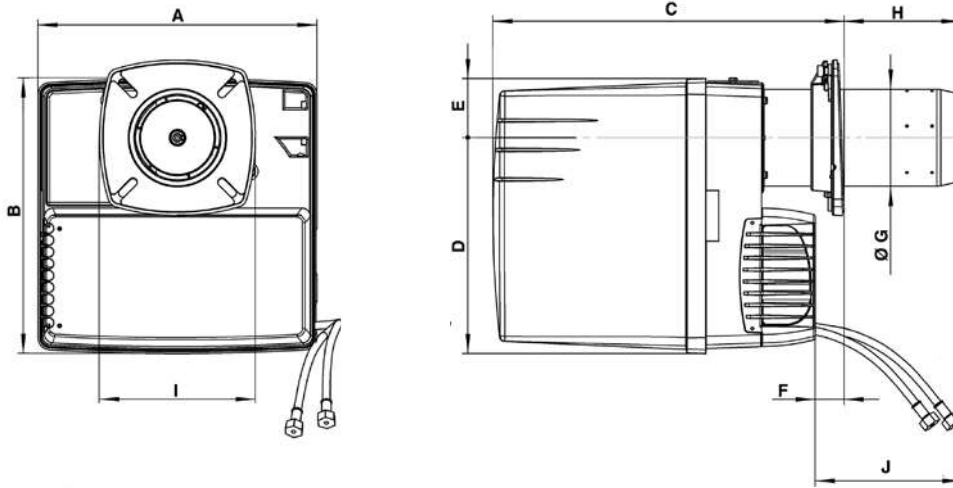

Model	A	B	C	D	E	F min	ØG	H max	I	J
			KL					KL		
VE2.100	331	326	398...638	256	133	15	115	264	185	700
VE2.150	331	326	398...638	256	133	15	115	264	185	700

Connecting flange

Øa (mm)	b (mm)	c	d
120-135	150-180	M8	45°

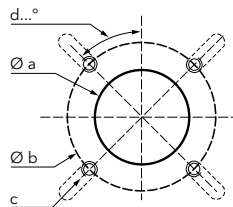

PACKAGING

The burner is delivered in a single package containing all the components

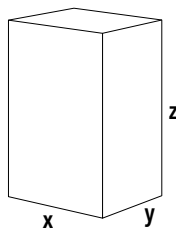

Burner	Dimensions (mm)			Gross weight (kg)
	X	Y	Z	
VE2.100 D	400	400	760	18
VE2.150 D	400	400	760	18

VB1.20 / VB1.24 / VB1.28 / VB1.30 / VB1.35

11 ... 35 kW
One stage (Blue Flame)

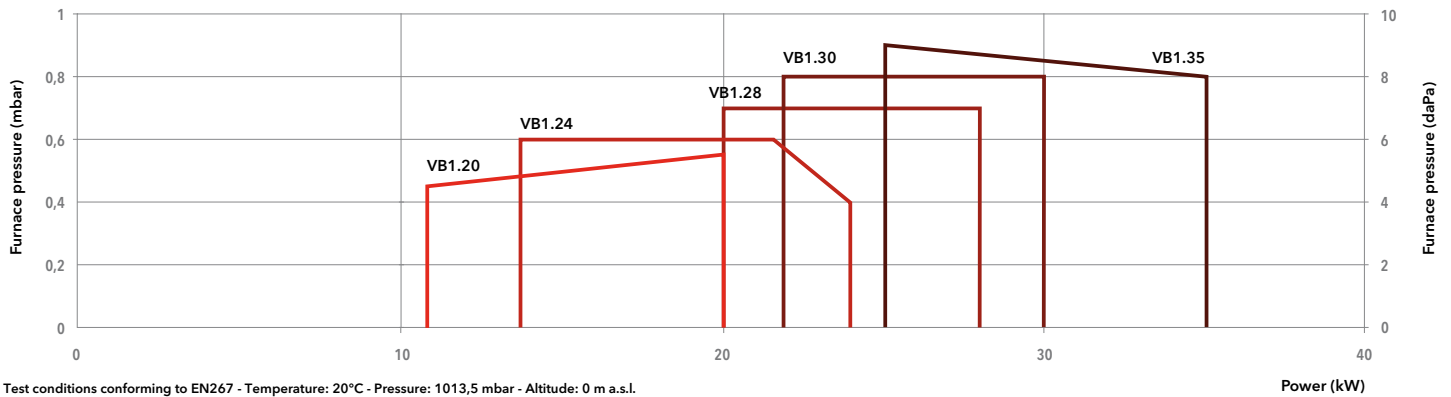

- **Fuel:** light oil (viscosity 6 mm²/s at 20°C, H_v = 11,86 kWh/kg)
- **Emissions:** NO_x < 100 mg/kWh (NCV), burners compliant with ErP Directive
- **Protection level:** IP 21

TECHNICAL DATA

Model	VB1.20	VB1.24	VB1.28	VB1.30	VB1.35
Operation range	11 - 20 kW	14 - 24 kW	20 - 28 kW	22 - 30 kW	25 - 35 kW
Fuel flow	0,9 - 1,7 kg/h	1,2 - 2,0 kg/h	1,7 - 2,4 kg/h	1,9 - 2,5 kg/h	2,1 - 3,0 kg/h
Nozzle	0,40 US gal/h 60°S	0,45 US gal/h 60°S	0,50 US gal/h 80°S	0,55 US gal/h 80°S	0,60 US gal/h 80°S
Control box / flame detection	TCH1... / IRD 1010	TCH1... / IRD 1010	TCH1... / IRD 1010	TCH1... / IRD 1010	TCH1... / IRD 1010
Fan motor	230 V - 50 Hz - 110 W	230 V - 50 Hz - 110 W	230 V - 50 Hz - 110 W	230 V - 50 Hz - 110 W	230 V - 50 Hz - 110 W
Electrical consumption	207 W	207 W	207 W	207 W	207 W
Flexible hoses	Rp 3/8" / M14 x 1,5 - 1000 mm				
Acoustic level (LpA)	59 dB(A)	59 dB(A)	59 dB(A)	59 dB(A)	59 dB(A)
Head length	KN	KN	KN	KN	KN
Complete burner code	3832624	3832625	3832626	3832627	3832628

OTHER AVAILABLE VERSIONS

 Versions for continuous ventilation and post-ventilation

SCOPE OF SUPPLY

The burner is delivered in its package complete with:

- 1 setting template
- 1 burner flange with insulation
- 1 bag containing installation fittings
- 1 bag containing technical documentation (instruction manual, technical data, electrical diagram, exploded view and spare parts list)



DIMENSIONS (mm)

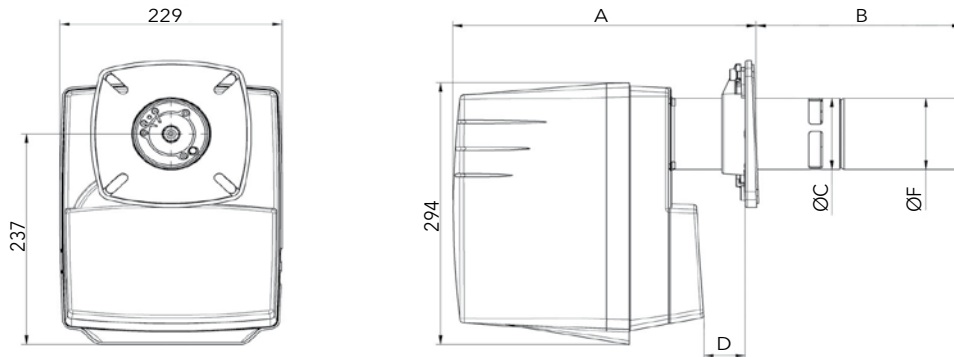

Model	A		B		ØC	D		ØF
	min	max	min	max		min	max	
VB1.20	269	284	234	249	80	12	27	80
VB1.24	269	284	234	249	80	12	27	80
VB1.28	269	284	234	249	80	12	27	100
VB1.30	269	284	244	259	80	12	27	100
VB1.35	269	284	294	309	80	12	27	120

Connecting flange

Øa (mm)	b (mm)	c	d
85-104	150-170	M8	45°

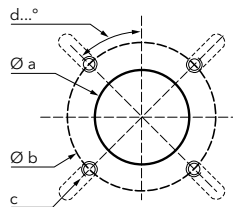

PACKAGING

The burner is delivered in a single package containing all the components

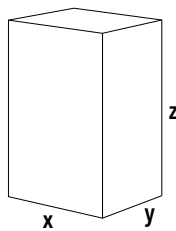

Burner	Dimensions (mm)			Gross weight (kg)
	X	Y	Z	
VB1.20	300	260	650	12
VB1.24	300	260	650	12
VB1.28	300	260	650	12
VB1.30	300	260	650	12
VB1.35	300	260	650	12

VB2.38 VD / VB2.45 VD / VB2.54 VD / VB2.66 VD

22 ... 66 kW
Two stages (Blue Flame)

- **Fuel:** light oil (viscosity 6 mm²/s at 20°C, H_v = 11,86 kWh/kg)
- **Emissions:** NO_x < 100 mg/kWh (GCV), burners compliant with ErP Directive
- **Protection level:** IP 21

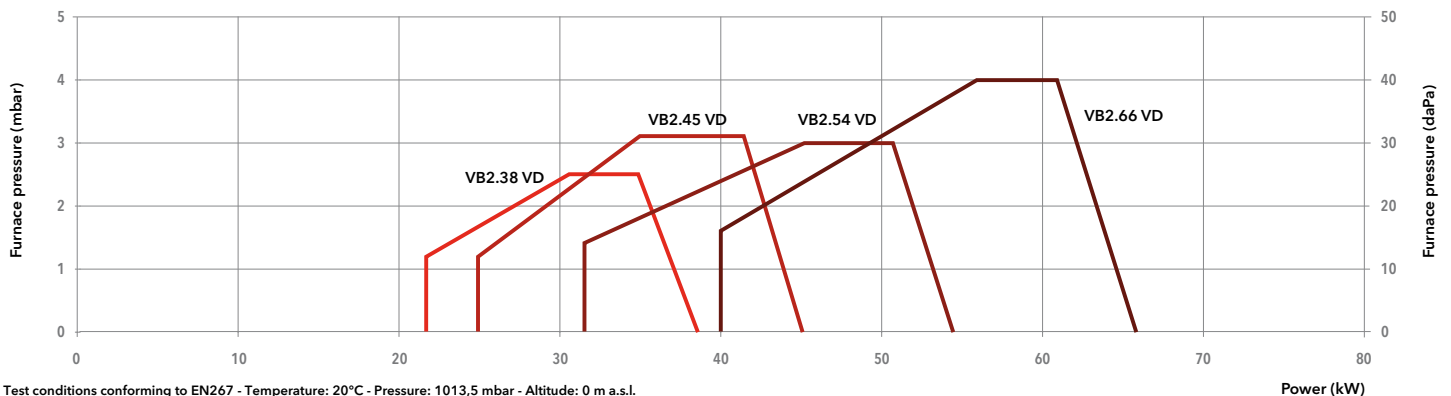
**TECHNICAL DATA**

Model	VB2.38 VD	VB2.45 VD	VB2.54 VD	VB2.66 VD
Operation range	22 - 38 kW	25 - 45 kW	32 - 54 kW	40 - 66 kW
Fuel flow	1,8 - 3,2 kg/h	2,1 - 3,8 kg/h	2,7 - 4,6 kg/h	3,4 - 5,6 kg/h
Nozzle	0,55 US gal/h 80°S	0,55 US gal/h 80°S	0,65 US gal/h 80°S	1,00 US gal/h 80°S
Control box / flame detection	TCH24x / IRD 1010	TCH24x / IRD 1010	TCH24x / IRD 1010	TCH24x / IRD 1010
Fan motor	230 V - 50 Hz - 56 W	230 V - 50 Hz - 190 W	230 V - 50 Hz - 190 W	230 V - 50 Hz - 190 W
Electrical consumption	191 W	287 W	325 W	310 W
Flexible hoses	Rp 3/8" / M14 x 1,5 - 1000 mm	Rp 3/8" / M14 x 1,5 - 1000 mm	Rp 3/8" / M14 x 1,5 - 1000 mm	Rp 3/8" / M14 x 1,5 - 1000 mm
Acoustic level (LpA)	59,3 dB(A)	67,2 dB(A)	70,2 dB(A)	68,4 dB(A)
Head length	KN	KN	KN	KN
Complete burner code	3835349	3835350	3835351	3835352

OTHER AVAILABLE VERSIONS

 Versions for continuous ventilation and post-ventilation

SCOPE OF SUPPLY

The burner is delivered in its package complete with:

- 1 setting template
- 1 burner flange with insulation
- 1 bag containing installation fittings
- 1 bag containing technical documentation (instruction manual, technical data, electrical diagram, exploded view and spare parts list)



DIMENSIONS (mm)

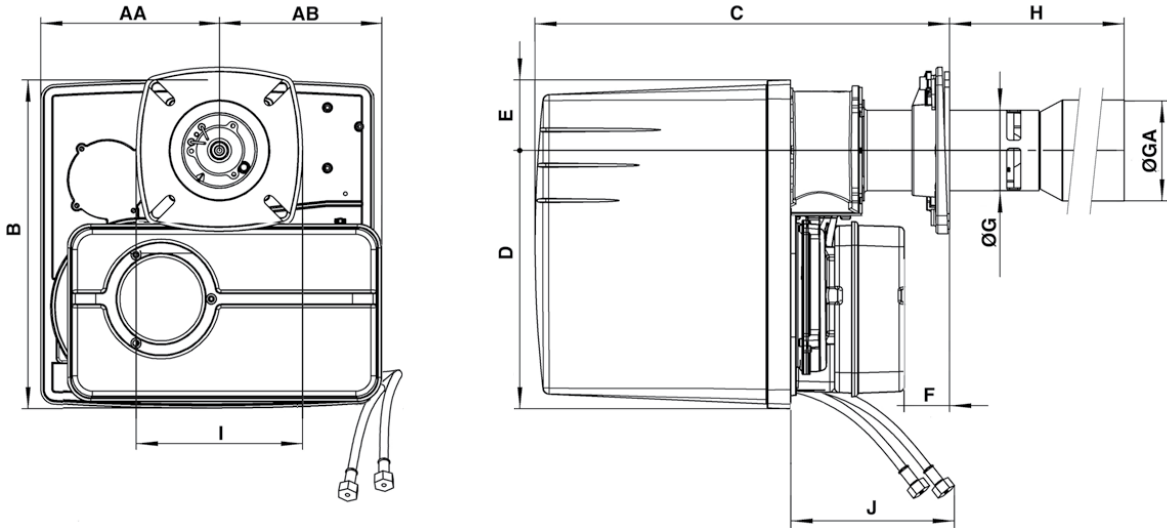

Model	AA	AB	B	C	D	E	F	ØG	ØGA	H	I	J
				KN						KN		
VB2.38 VD	178	153	325	390...450	256	69	15...75	80	100	245...185	165	1200
VB2.45 VD	178	153	325	390...450	256	69	15...75	80	100	245...185	165	1200
VB2.54 VD	178	153	325	390...450	256	69	15...75	80	100	245...185	165	1200
VB2.66 VD	178	153	325	390...450	256	69	15...75	100	120	300...240	185	1200

Connecting flange

Model	Øa (mm)	b (mm)	c	d
VB2.38/45/54 VD	85-104	150-170	M8	45°
VB2.66 VD	110-135	150-184	M8	45°

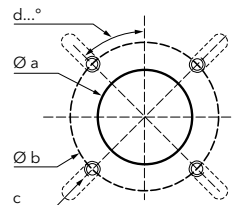

PACKAGING

The burner is delivered in a single package containing all the components

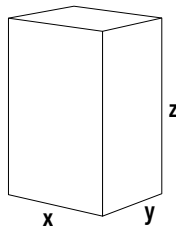

Burner	Dimensions (mm)			Gross weight (kg)
	X	Y	Z	
VB2.38 VD	400	400	760	17
VB2.45 VD	400	400	760	17
VB2.54 VD	400	400	760	17
VB2.66 VD	400	400	760	17

VB2.77 VD / VB2.85 VD / VB2.95 VD

45 ... 95 kW
Two stages (Blue Flame)

- **Fuel:** light oil (viscosity 6 mm²/s at 20°C, H_v = 11,86 kWh/kg)
- **Emissions:** NO_x < 100 mg/kWh (GCV), burners compliant with ErP Directive
- **Protection level:** IP 21

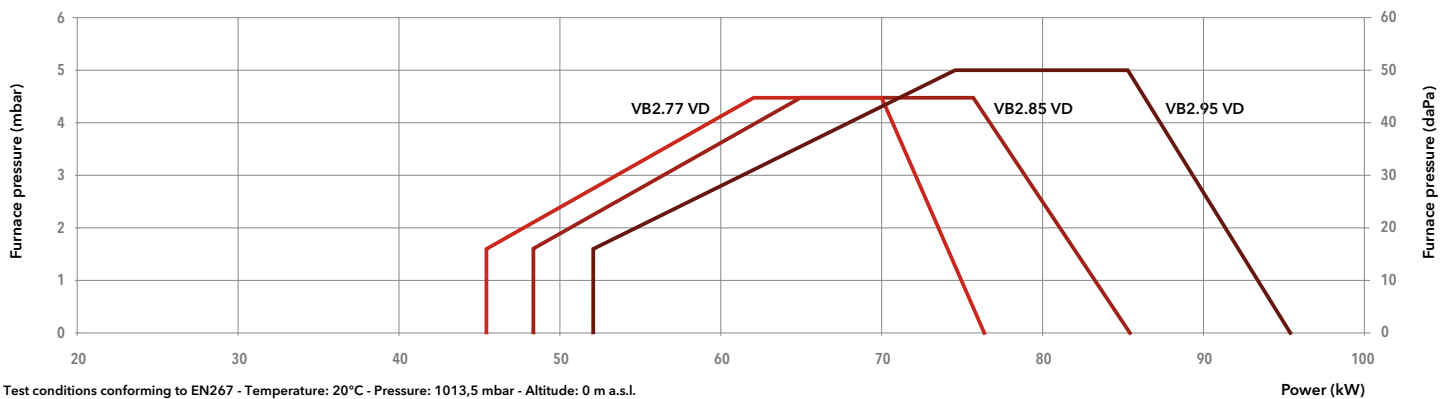
**TECHNICAL DATA**

Model	VB2.77 VD	VB2.85 VD	VB2.95 VD
Operation range	45 - 77 kW	48 - 85 kW	52 - 95 kW
Fuel flow	3,8 - 6,5 kg/h	4,0 - 7,2 kg/h	4,4 - 8,0 kg/h
Nozzle	1,10 US gal/h 80°S	1,25 US gal/h 80°S	1,25 US gal/h 80°S
Control box / flame detection	TCH24x / IRD 1010	TCH24x / IRD 1010	TCH24x / IRD 1010
Fan motor	230 V - 50 Hz - 190 W	230 V - 50 Hz - 190 W	230 V - 50 Hz - 190 W
Electrical consumption	276 W	285 W	262 W
Flexible hoses	Rp 3/8" / DN6 x 1,5 - 1500 mm	Rp 3/8" / DN6 x 1,5 - 1500 mm	Rp 3/8" / DN6 x 1,5 - 1500 mm
Acoustic level (LpA)	68,5 dB(A)	66,5 dB(A)	67,6 dB(A)
Head length	KN	KN	KN
Complete burner code	3835353	3835354	3835355

OTHER AVAILABLE VERSIONS

 Versions for continuous ventilation and post-ventilation

SCOPE OF SUPPLY

The burner is delivered in its package complete with:

- 1 setting template
- 1 burner flange with insulation
- 1 bag containing installation fittings
- 1 bag containing technical documentation (instruction manual, technical data, electrical diagram, exploded view and spare parts list)



DIMENSIONS (mm)

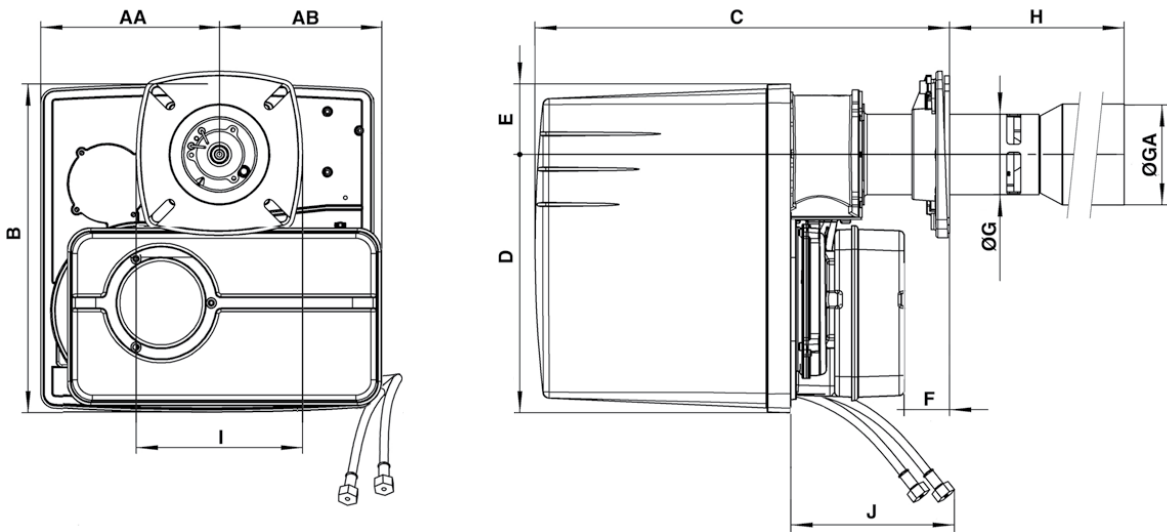

Model	AA	AB	B	C	D	E	F	ØG	ØGA	H	I	J
				KN						KN		
VB2.77 VD	178	153	325	390...450	256	69	15...75	100	120	300...240	185	1200
VB2.85 VD	178	153	325	390...450	256	69	15...75	100	120	300...240	185	1200
VB2.95 VD	178	153	325	390...450	256	69	15...75	100	120	300...240	185	1200

Connecting flange

Øa (mm)	b (mm)	c	d
110-135	150-184	M8	45°

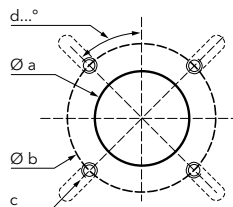

PACKAGING

The burner is delivered in a single package containing all the components

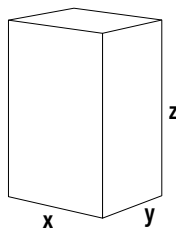

Burner	Dimensions (mm)			Gross weight (kg)
	X	Y	Z	
VB2.77 VD	400	400	760	17
VB2.85 VD	400	400	760	17
VB2.95 VD	400	400	760	17

VB30.120 D / VB30.190 D / VB30.230 D

50 ... 240 kW

Two stages

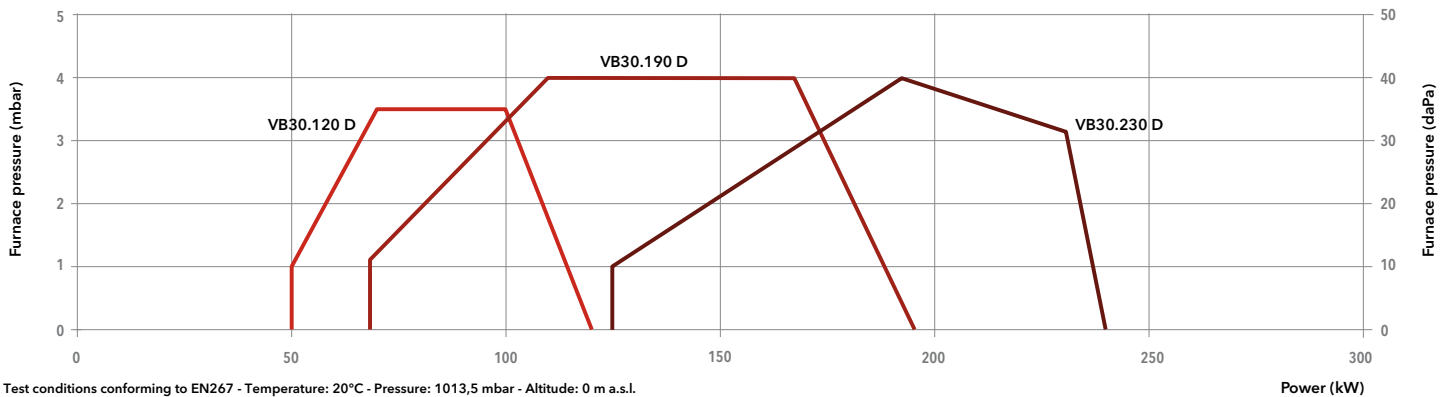

- Fuel: light oil, Hi = 11,86 kWh/kg;
- Emissions: NO_x < 100 mg/kWh (GCV), burners compliant with ErP Directive
- Protection level: IP 21

TECHNICAL DATA

Model	VB30.120 D	VB30.190 D	VB30.230 D
Operation range	50 - 120 kW	68 - 195 kW	125 - 240 kW
Fuel flow	4,2 - 10,1 kg/h	5,7 - 16,4 kg/h	10,5 - 20,2 kg/h
Nozzles	1,65 US gal/h 80°S	2,75 US gal/h 80°A	3,25 US gal/h 80°A
Control box / flame detection	DK0992 / KLC2002	DK0992 / KLC2002	DK0992 / KLC2002
Fan motor	230 V - 50 Hz - 260 W	230 V - 50 Hz - 380 W	230 V - 50 Hz - 380 W
Electrical consumption	360 W	550 W	550 W
Acoustic level (LpA)	68 dB(A)	69 dB(A)	69 dB(A)
Complete burner code	3722921	3722922	3722923

OTHER AVAILABLE VERSIONS

 Versions for continuous ventilation and post-ventilation

SCOPE OF SUPPLY

The burner is delivered in its package complete with:

- 1 burner head with flange seal and securing screws
- 1 bag containing installation fittings
- 1 bag containing technical documentation (instruction manual, technical data, electrical diagram, exploded view and spare parts list)



DIMENSIONS (mm)

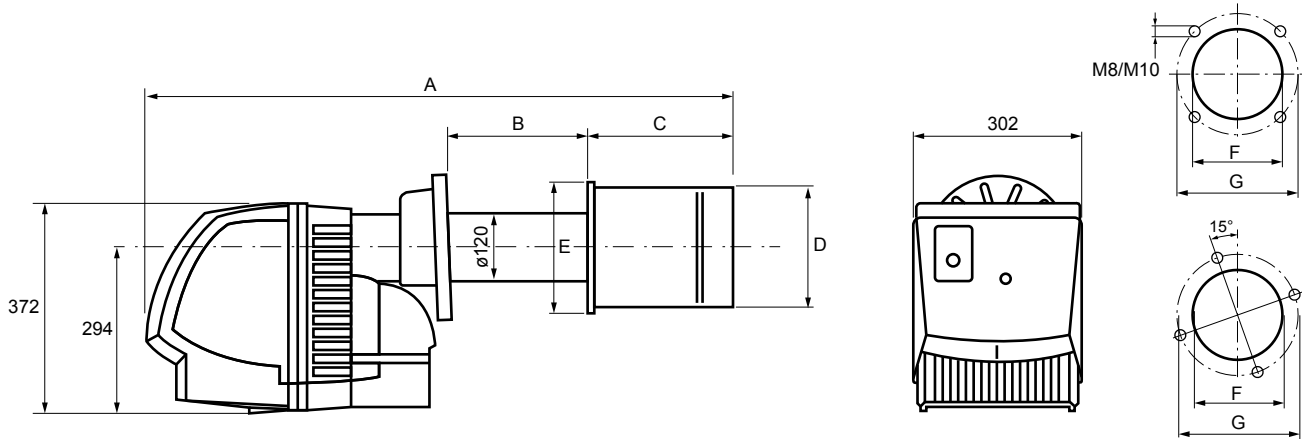

Model	A	B	C	ØD	ØE	ØF	ØG
VB30.120 D	824	max 145	180	150	175	min 130	170 - 220
VB30.190 D	856	max 145	210	160	190	min 130	170 - 220
VB30.230 D	866	max 145	220	160	212	min 130	170 - 220

PACKAGING

The burner is delivered in a single package containing all the components

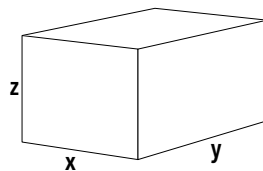

Burner	Dimensions (mm)			Gross weight (kg)
	X	Y	Z	
VB30.120	430	370	800	29
VB30.190	430	370	800	29
VB30.230	430	370	800	29

VB35.320 D / VB35.370 D120 ... 375 kW
Two stages

- **Fuel:** light oil, Hi = 11,86 kWh/kg;
- **Emissions:** NO_x < 100 mg/kWh (GCV), burners compliant with ErP Directive
- **Protection level:** IP 21

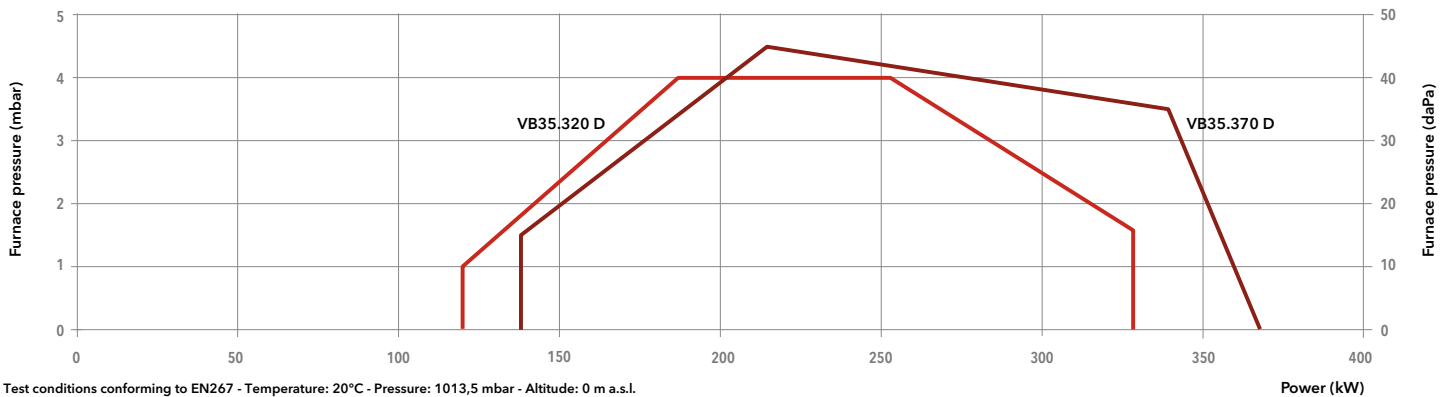
TECHNICAL DATA

Model	VB35.320 D	VB35.370 D
Operation range	120 - 330 kW	140 - 375 kW
Fuel flow	10,1 - 27,8 kg/h	11,8 - 31,6 kg/h
Nozzles	3,50 US gal/h 80°A	4,50 US gal/h 80°A
Control box / flame detection	DKO992 / KLC2002	DKO992 / KLC2002
Fan motor	230 V - 50 Hz - 650 W	230 V - 50 Hz - 650 W
Electrical consumption	830 W	830 W
Acoustic level (LpA)	72 dB(A)	72 dB(A)
Complete burner code	3722924	3722925

OTHER AVAILABLE VERSIONS

 Versions for continuous ventilation and post-ventilation

SCOPE OF SUPPLY

The burner is delivered in its package complete with:

- 1 burner head with flange seal and securing screws
- 1 bag containing installation fittings
- 1 bag containing technical documentation (instruction manual, technical data, electrical diagram, exploded view and spare parts list)



DIMENSIONS (mm)

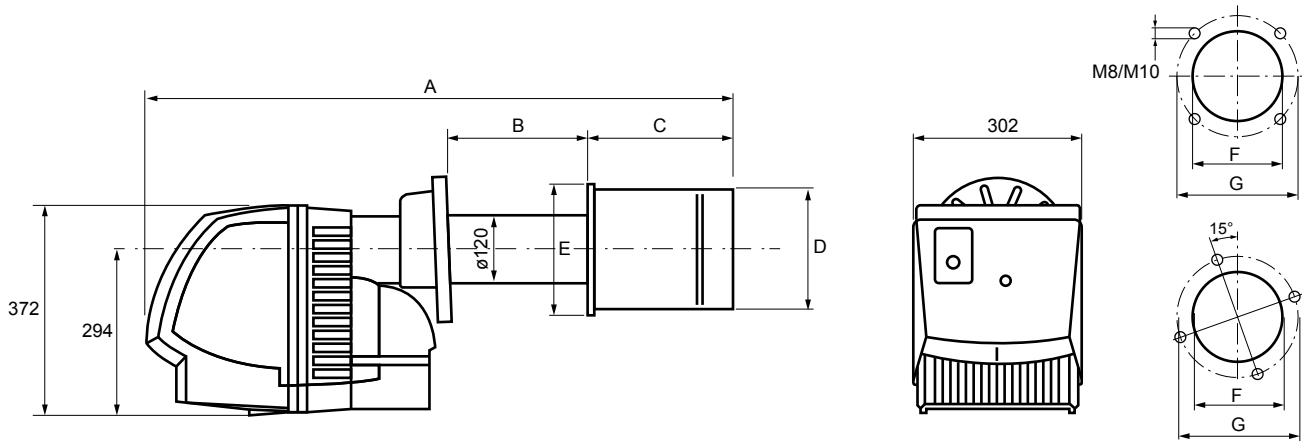

Model	A	B	C	ØD	ØE	ØF	ØG
VB35.320 D	1010	max 260	220	180	212	min 130	170 - 220
VB35.370 D	1048	max 260	260	210	230	min 130	170 - 220

PACKAGING

The burner is delivered in a single package containing all the components

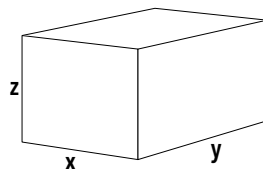

Burner	Dimensions (mm)			Gross weight (kg)
	X	Y	Z	
VB35.320	490	400	890	37
VB35.370	490	400	890	37

VB40.420 D / VB40.460 D / VB40.590 D / VB45.810 D135 ... 825 kW
Two stages

- **Fuel:** light oil, Hi = 11,86 kWh/kg;
- **Emissions:** NOx < 100 mg/kWh (GCV), Low NOx class 3 burners according to EN267
- **Protection level:** IP 21

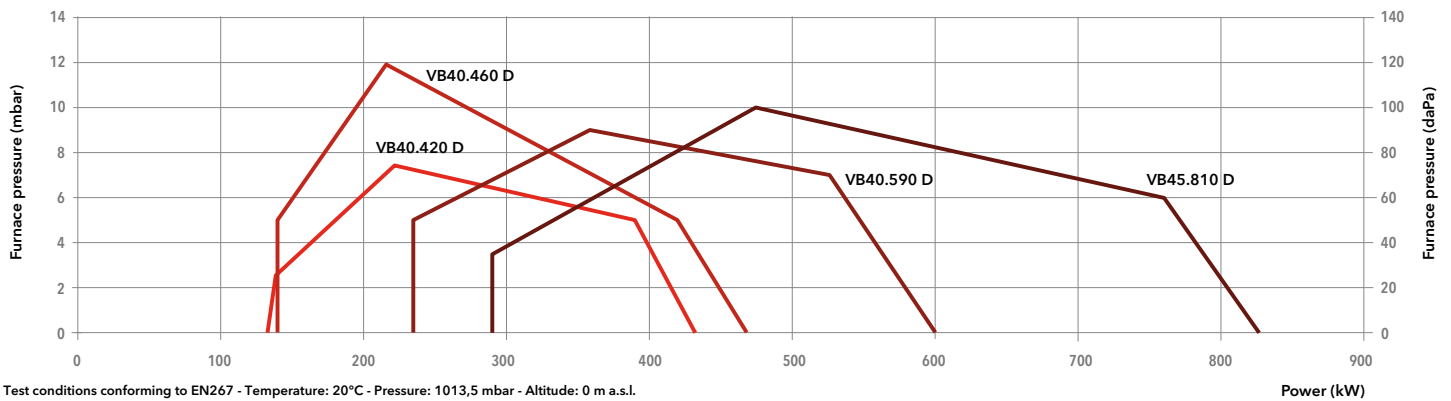
TECHNICAL DATA

Model	VB40.420 D	VB40.460 D	VB40.590 D	VB45.810 D
Operation range	135 - 430 kW	140 - 470 kW	230 - 600 kW	290 - 825 kW
Fuel flow	11,4 - 36,2 kg/h	11,8 - 39,6 kg/h	19,4 - 50,6 kg/h	24,4 - 69,5 kg/h
Nozzles	5,50 US gal/h 80°A	7,00 US gal/h 80°A	7,00 US gal/h 80°A	9,50 US gal/h 80°A
Control box / flame detection	DKO992 / KLC2002	DKO992 / KLC2002	DKO992 / KLC2002	DKO992 / KLC2002
Fan motor	230 V - 50 Hz - 750 W	230 V - 50 Hz - 1100 W	230 V - 50 Hz - 1100 W	230 V - 50 Hz - 2200 W
Electrical consumption	1280 W	1450 W	2050 W	2480 W
Acoustic level (LpA)	69 dB(A)	69 dB(A)	70 dB(A)	74 dB(A)
Complete burner code	3722926	3722927	3722928	3722929

OTHER AVAILABLE VERSIONS

 Versions for continuous ventilation and post-ventilation

SCOPE OF SUPPLY

The burner is delivered in its package complete with:

- 1 burner head with flange seal and securing screws
- 1 bag containing installation fittings
- 1 bag containing technical documentation (instruction manual, technical data, electrical diagram, exploded view and spare parts list)



DIMENSIONS (mm)

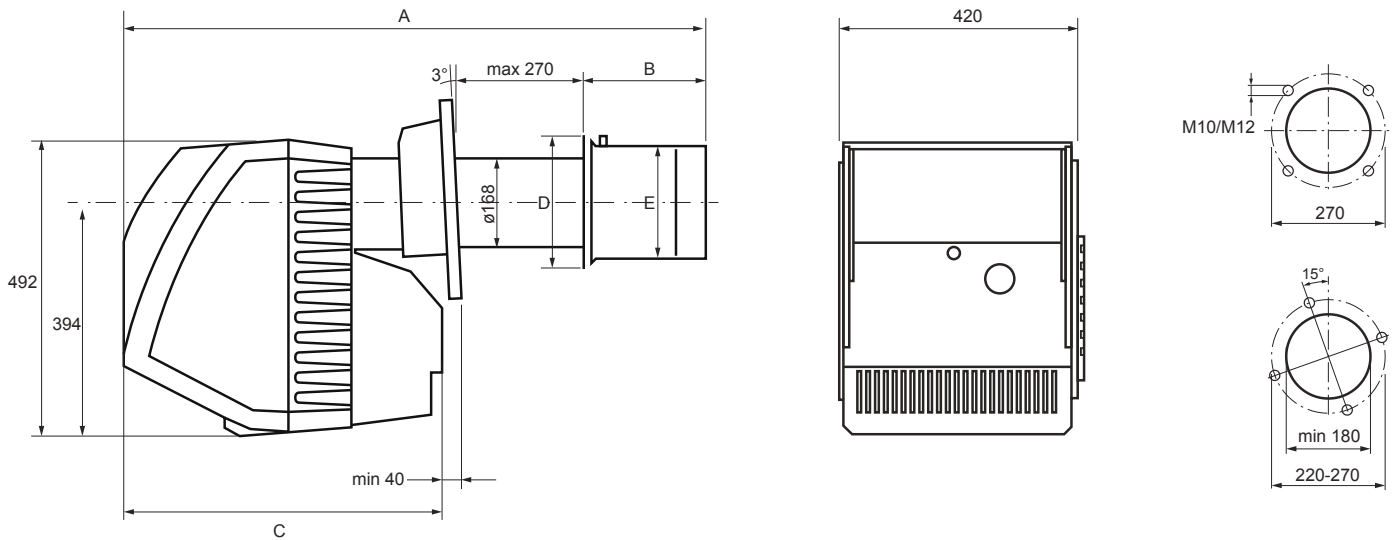

Model	A	B	C	ØD	ØE
VB40.420 D	1176	255	611	210	300
VB40.460 D	1176	255	611	210	300
VB40.590 D	1206	285	611	250	300
VB45.810 D	1291	330	651	280	330

PACKAGING

The burner is delivered in a single package containing all the components

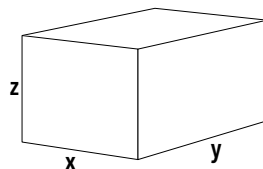

Burner	Dimensions (mm)			Gross weight (kg)
	X	Y	Z	
VB40.420	540	540	1180	60
VB40.460	540	540	1180	60
VB40.590	540	540	1180	60
VB45.810	540	540	1180	65

EK EVO 4 L-EOT / EK EVO 5 L-EOT

260 ... 1450 kW

Two stage progressive/modulating electronic



- **Fuel:** light oil, Hi = 11,86 kWh/kg;
- **Emissions:** Ultra low NO_x burners with NO_x values between 62 and 76 mg/kWh (NCV)
- **Protection level:** IP 40 (IP 54 as option)

TECHNICAL DATA

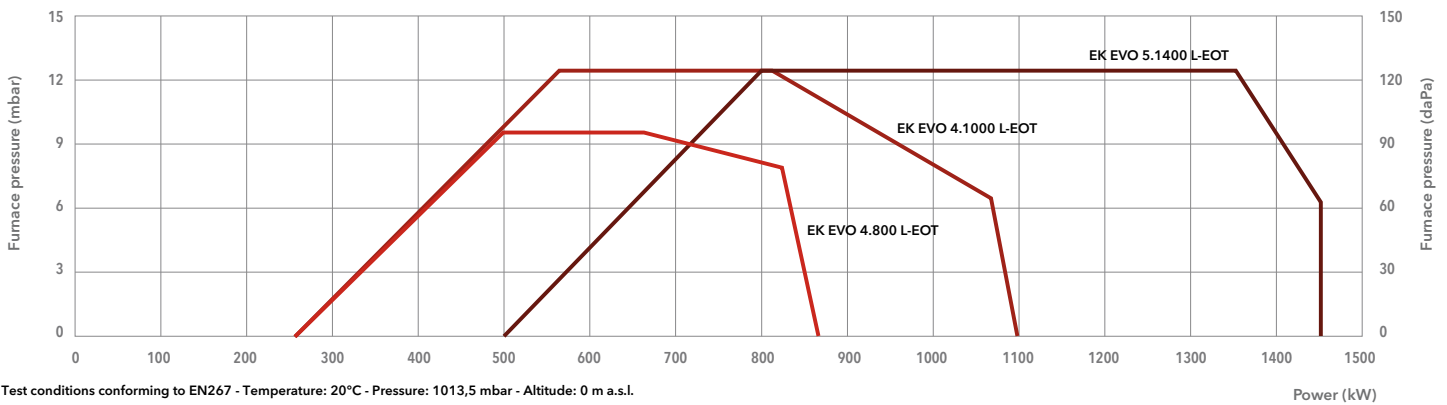

Test conditions conforming to EN267 - Temperature: 20°C - Pressure: 1013,5 mbar - Altitude: 0 m a.s.l.

	EK EVO 4.800 L-EOT	EK EVO 4.1000 L-EOT	EK EVO 5.1400 L-EOT
Operating range	260 - 870 kW	260 - 1100 kW	500 - 1450 kW
Fuel connection	DN20 x 1500 mm / R 1/2"	DN20 x 1500 mm / R 3/4"	DN20 x 1500 mm / R 3/4"
Control box / flame detector	BT300 / KLC20*	BT300 / KLC20*	BT300 / KLC20*
Auxiliary voltage	1NPE AC 230 V - 50 Hz TN-S	1NPE AC 230 V - 50 Hz TN-S	1NPE AC 230 V - 50 Hz TN-S
Power supply	3PE AC 400 V - 50 Hz	3PE AC 400 V - 50 Hz	3PE AC 400 V - 50 Hz
Electric motor	2,2 kW	2,2 kW	4 kW
Pump	SUNTEC AJ6 - 230 l/h - 30 bar	SUNTEC AJ6 - 230 l/h - 30 bar	HP UHE-A2 - 400 l/h - 30 bar
Acoustic level	<80,5 dB(A)	<80,5 dB(A)	<83,3 dB(A)
Complete burner code	3758954	3758953	3758955

*: FFS08 optional for model in PED configuration

OTHER AVAILABLE VERSIONS

PED PED version for continuous operation

	EK EVO 4.800 L-EOT / PED	EK EVO 4.1000 L-EOT / PED	EK EVO 5.1400 L-EOT / PED
Burner codes (body + head)	3759111	3759112	3759113

SCOPE OF SUPPLY

The burner is delivered in its package complete with:

- 1 burner head with flange seal and securing screws
- 1 bag containing installation fittings
- 1 bag containing technical documentation (instruction manual, technical data, electrical diagram, exploded view and spare parts list)



DIMENSIONS (mm)

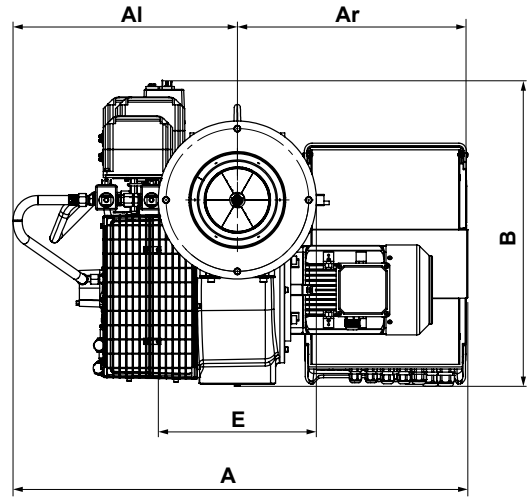
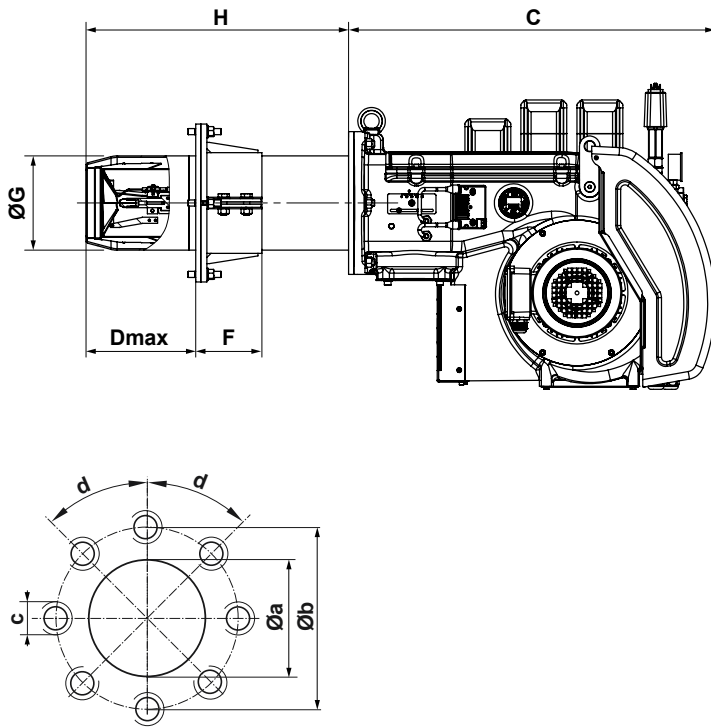

Model	A	Al	Ar	B	C	D max	E	F	ØG	H	Øa	b	c	d
EK EVO 4.800 L-EOT	850	400	450	610	715	370	310	145	185	515	205	280	M12	45°
EK EVO 4.1000 L-EOT	850	400	450	610	715	410	370	145	220	555	250	340	M12	45°
EK EVO 5.1400 L-EOT	855	400	455	630	810	510	370	145	220	655	250	340	M12	45°

PACKAGING

The burner is delivered in a single package containing all the components

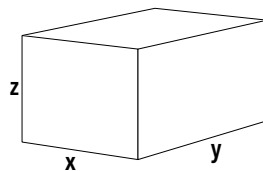

Burner	Dimensions (mm)			Gross weight (kg)
	X	Y	Z	
EK EVO 4.800	1140	1370	950	170,5
EK EVO 4.1000	1140	1370	950	170,5
EK EVO 5.1400	1000	1500	940	199,5

VL1.40 P / VL1.55 P / VL1.42 / VL1.55 / VL1.105

18 ... 105 kW
One stage



- **Fuel:** light oil (viscosity 6 mm²/s at 20°C, H_v = 11,86 kWh/kg)
- **Emissions:** NO_x < 120 mg/kWh (GCV), burners compliant with ErP Directive
- **Protection level:** IP 21

TECHNICAL DATA

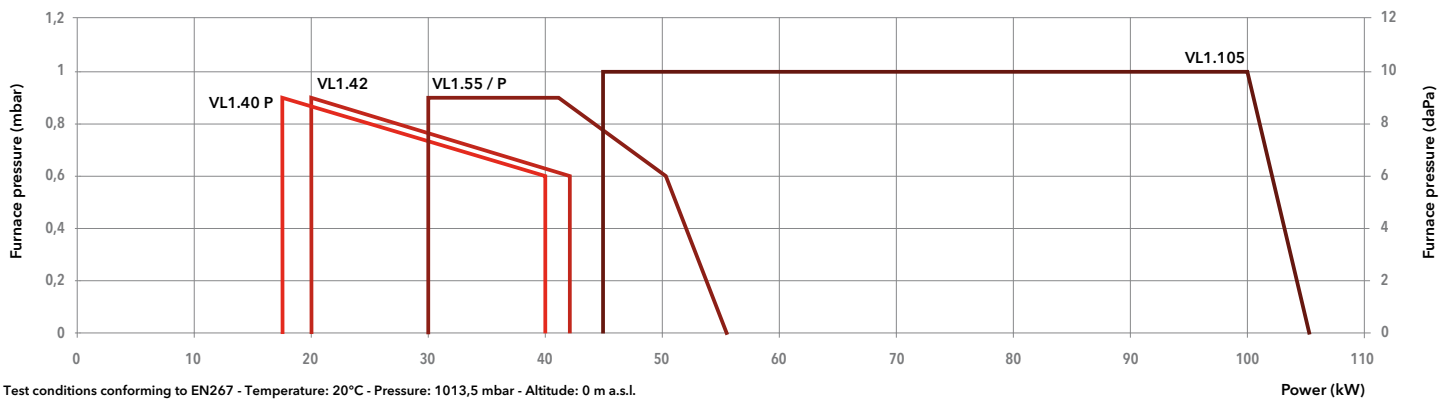

Test conditions conforming to EN267 - Temperature: 20°C - Pressure: 1013,5 mbar - Altitude: 0 m a.s.l.

Model	VL1.40 P *	VL1.55 P *	VL1.42	VL1.55	VL1.105	
Operation range	18 - 40 kW	30 - 55 kW	20 - 42 kW	30 - 55 kW	45 - 105 kW	
Fuel flow	1,5 - 3,3 kg/h	2,5 - 4,6 kg/h	1,7 - 3,5 kg/h	2,5 - 4,6 kg/h	3,8 - 8,8 kg/h	
Nozzle	0,50 US gal/h 60°S	1,00 US gal/h 45°S	0,60 US gal/h 60°S	1,00 US gal/h 45°S	1,25 US gal/h 45°S	
Control box / flame detection	TCH1... / FTEB					
Fan motor	230 V - 50 Hz - 110 W					
Electrical consumption	244 W	244 W	195 W	195 W	240 W	
Flexible hoses	Rp 3/8" / M14 x 1,5 - 1000 mm					
Acoustic level (LpA)	55 dB(A)	55 dB(A)	55 dB(A)	55 dB(A)	60,5 dB(A)	
Head length	KN	KN	KN	KN	KN	KL
Complete burner code	3832615	3833026	3832616	3832617	3836898	3836899

*: pre-heater

OTHER AVAILABLE VERSIONS

 Versions for continuous ventilation and post-ventilation

SCOPE OF SUPPLY

The burner is delivered in its package complete with:

- 1 burner flange with insulation
- 1 bag containing installation fittings
- 1 bag containing technical documentation (instruction manual, technical data, electrical diagram, exploded view and spare parts list)



DIMENSIONS (mm)

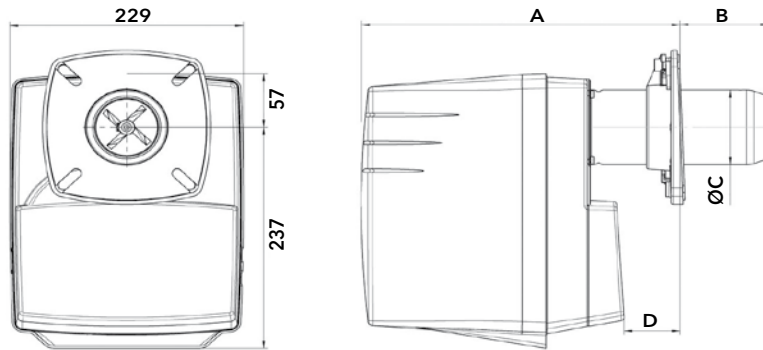

Model	A		B			ØC	D	
	min	max	min	KN max	KL max		min	max
VL1.40 P	270	310	70	120	-	80	21	71
VL1.42	270	310	70	120	-	80	21	71
VL1.55	270	310	70	120	-	80	21	71
VL1.55 P	270	310	70	120	-	80	21	71
VL1.105	297	357	70	138	200	90	15	83

Connecting flange

Model	Øa (mm)	b (mm)	c	d
VL1.40/55	85-104	150-170	M8	45°
VL1.105	95-104	150-170	M8	45°

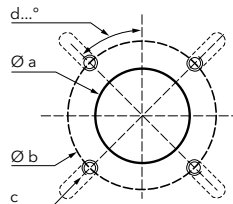

PACKAGING

The burner is delivered in a single package containing all the components

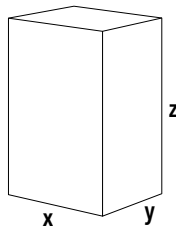

Burner	Dimensions (mm)			Gross weight (kg)
	X	Y	Z	
VL1.40 P	300	260	650	11
VL1.42	300	260	650	11
VL1.55	300	260	650	11
VL1.55 P	300	260	650	11
VL1.105	300	260	650	12

VL2.140 / VL2.200

80 ... 200 kW

One stage

- **Fuel:** light oil (viscosity 6 mm²/s at 20°C, H_v = 11,86 kWh/kg)
- **Emissions:** NO_x < 120 mg/kWh (GCV), burners compliant with ErP Directive
- **Protection level:** IP 21

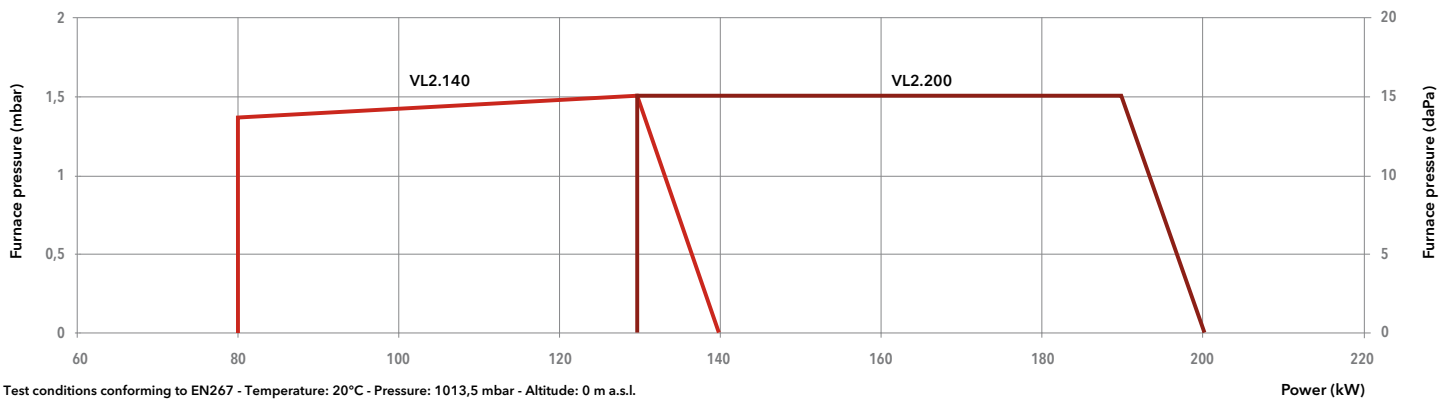
**TECHNICAL DATA**

Model	VL2.140		VL2.200	
Operation range	80 - 140 kW		130 - 200 kW	
Fuel flow	6,7 - 11,8 kg/h		11 - 16,9 kg/h	
Nozzle	2,25 US gal/h 45°S		3,50 US gal/h 45°S	
Control box / flame detection	TCH1... / QRB1		TCH1... / QRB1	
Fan motor	230 V - 50 Hz - 160 W		230 V - 50 Hz - 130 W	
Electrical consumption	274 W		290 W	
Flexible hoses	Rp 3/8" / DN6 x 1,5 - 1500 mm		Rp 3/8" / DN6 x 1,5 - 1500 mm	
Acoustic level (LpA)	62 dB(A)		65 dB(A)	
Head length	KN	KL	KN	KL
Complete burner code	3833536	3833537	3833540	3833541

OTHER AVAILABLE VERSIONS

 Versions for continuous ventilation and post-ventilation

SCOPE OF SUPPLY

The burner is delivered in its package complete with:

- 2 oil hoses
- 1 burner flange with insulation
- 1 bag containing installation fittings
- 1 bag containing technical documentation (instruction manual, technical data, electrical diagram, exploded view and spare parts list)



DIMENSIONS (mm)

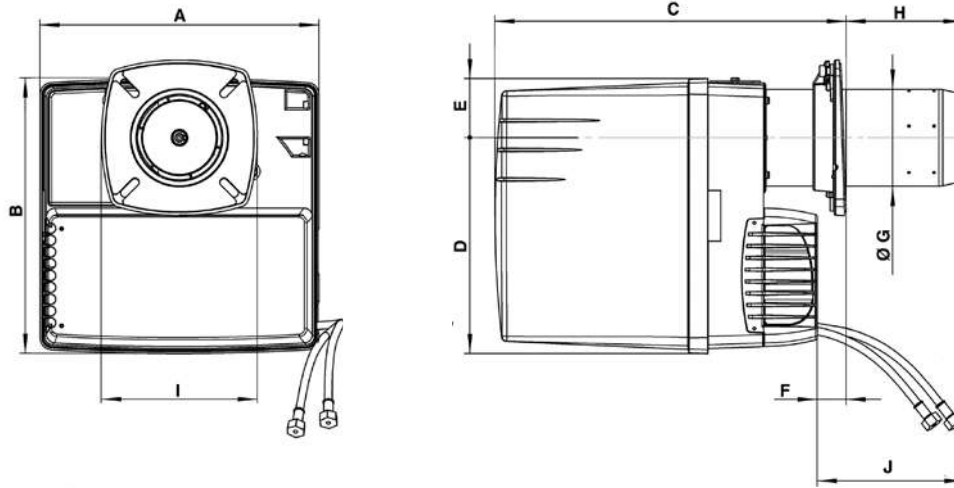

Model	A	B	C		D	E	F min	ØG	H		I	J
			KN	KL					KN	KL		
VL2.140	331	325	398...518	398...638	256	69	15	100	30...150	30...270	185	1200
VL2.200	331	325	398...518	398...638	256	69	15	115	30...150	30...270	185	1200

Connecting flange

Øa (mm)	b (mm)	c	d
120-135	150-184	M8	45°

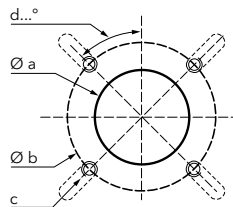

PACKAGING

The burner is delivered in a single package containing all the components

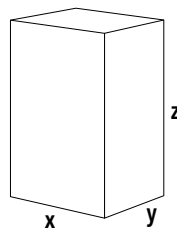

Burner	Dimensions (mm)			Gross weight (kg)
	X	Y	Z	
VL2.140	400	400	760	18
VL2.200	400	400	760	18

VL2.120 D / VL2.160 D / VL2.210 D

60 ... 210 kW

Two stages

- **Fuel:** light oil (viscosity 6 mm²/s at 20°C, H_v = 11,86 kWh/kg)
- **Emissions:** NO_x < 120 mg/kWh (GCV), burners compliant with ErP Directive
- **Protection level:** IP 21

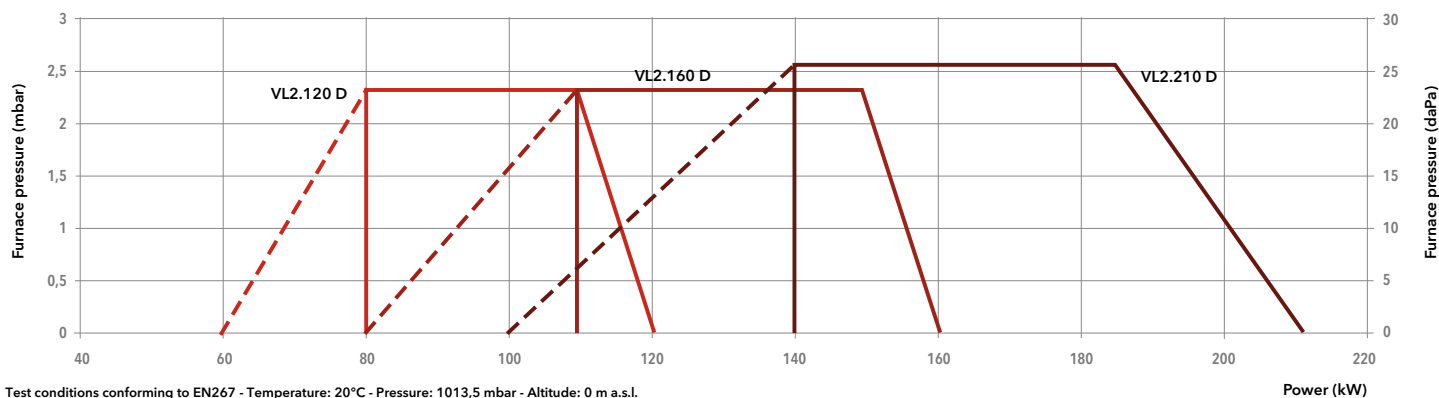
**TECHNICAL DATA**

Model	VL2.120 D		VL2.160 D		VL2.210 D	
Operation range	(60) 80 - 120 kW		(80) 110 - 160 kW		(100) 140 - 210 kW	
Fuel flow	4,6 - 10,0 kg/h		6,1 - 13,5 kg/h		8,4 - 17,7 kg/h	
Nozzles	1,50 US gal/h 45°S		2,25 US gal/h 45°S		2,75 US gal/h 45°S	
Control box / flame detection	TCH2... / QRB1A		TCH2... / QRB1A		TCH2... / QRB1A	
Fan motor	230 V - 50 Hz - 160 W		230 V - 50 Hz - 160 W		230 V - 50 Hz - 130 W	
Electrical consumption	216 W		290 W		345 W	
Flexible hoses	Rp 3/8" / M14 x 1,5 - 1500 mm		Rp 3/8" / M14 x 1,5 - 1500 mm		Rp 3/8" / M14 x 1,5 - 1500 mm	
Acoustic level (LpA)	62 dB(A)		64 dB(A)		65 dB(A)	
Head length	KN	KL	KN	KL	KN	KL
Complete burner code	3833344	3833345	3833346	3833347	3833348	3833349

OTHER AVAILABLE VERSIONS

 Versions for continuous ventilation and post-ventilation

SCOPE OF SUPPLY

The burner is delivered in its package complete with:

- 1 setting template
- 1 burner flange with insulation
- 1 bag containing installation fittings
- 1 bag containing technical documentation (instruction manual, technical data, electrical diagram, exploded view and spare parts list)



DIMENSIONS (mm)

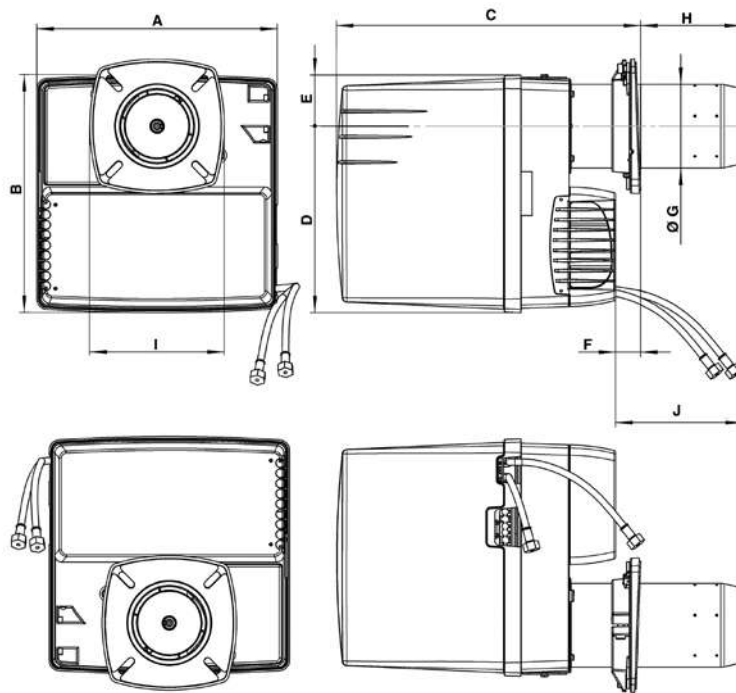

A	B	C		D	E	F min	ØG	H		I	J
		KN	KL					KN	KL		
331	326	398...518	398...638	256	69	15	115	30...150	30...270	185x185	1200

Connecting flange

Øa (mm)	b (mm)	c	d
120-135	150-184	M8	45°

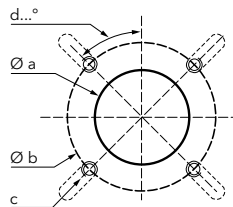

PACKAGING

The burner is delivered in a single package containing all the components

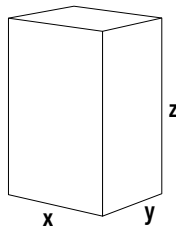

Burner	Dimensions (mm)			Gross weight (kg)
	X	Y	Z	
VL2.120 D	400	400	770	18
VL2.160 D	400	400	770	18
VL2.210 D	400	400	770	19

VL3.290 D / VL3.360 D / VL4.440 D130 ... 440 kW
Two stages

- **Fuel:** light oil (viscosity 6 mm²/s at 20°C, H_v = 11,86 kWh/kg)
- **Emissions:** NO_x < 120 mg/kWh (GCV), burners compliant with ErP Directive
- **Protection level:** IP 21

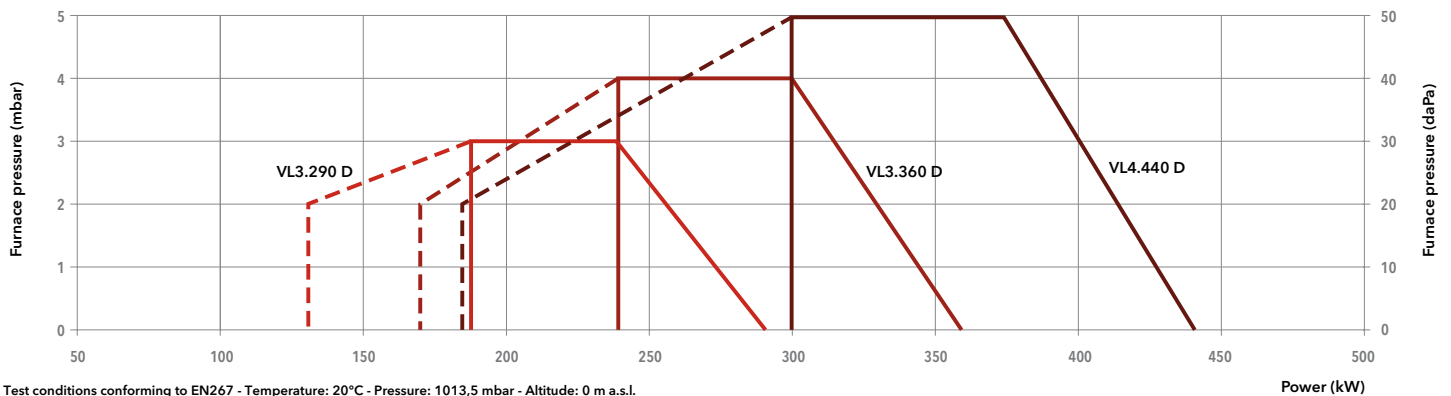
TECHNICAL DATA

Model	VL3.290 D		VL3.360 D		VL4.440 D	
Operation range	(130) 185 - 290 kW		(170) 240 - 360 kW		(180) 300 - 440 kW	
Fuel flow	15,6 - 24,4 kg/h		20,2 - 30,3 kg/h		25,3 - 37,0 kg/h	
Nozzles	3,75 US gal/h 60°B		4,50 US gal/h 60°B		5,00 US gal/h 60°S / 3,5 US gal/h 60°S	
Control box / flame detection	TCH2... / QRB1A		TCH2... / QRB1A		TCH2... / QRB1A	
Fan motor	230 V - 50 Hz - 250 W		230 V - 50 Hz - 300 W		230 V - 50 Hz - 750 W	
Electrical consumption	445 W		540 W		27 + 785 W	
Flexible hoses	Rp 3/8" / DN6 x 1500 mm		Rp 3/8" / DN6 x 1500 mm		Rp 3/8" / DN6 x 1500 mm	
Acoustic level (LpA)	67 dB(A)		69 dB(A)		70 dB(A)	
Head length	KN	KL	KN	KL	KN	KL
Complete burner code	3833072	3833073	3833070	3833071	3836614	3836615

OTHER AVAILABLE VERSIONS

 Versions for continuous ventilation and post-ventilation

SCOPE OF SUPPLY

The burner is delivered in its package complete with:

- 1 burner head with flange seal and securing screws
- 1 bag containing installation fittings
- 1 bag containing technical documentation (instruction manual, technical data, electrical diagram, exploded view and spare parts list)



DIMENSIONS (mm)

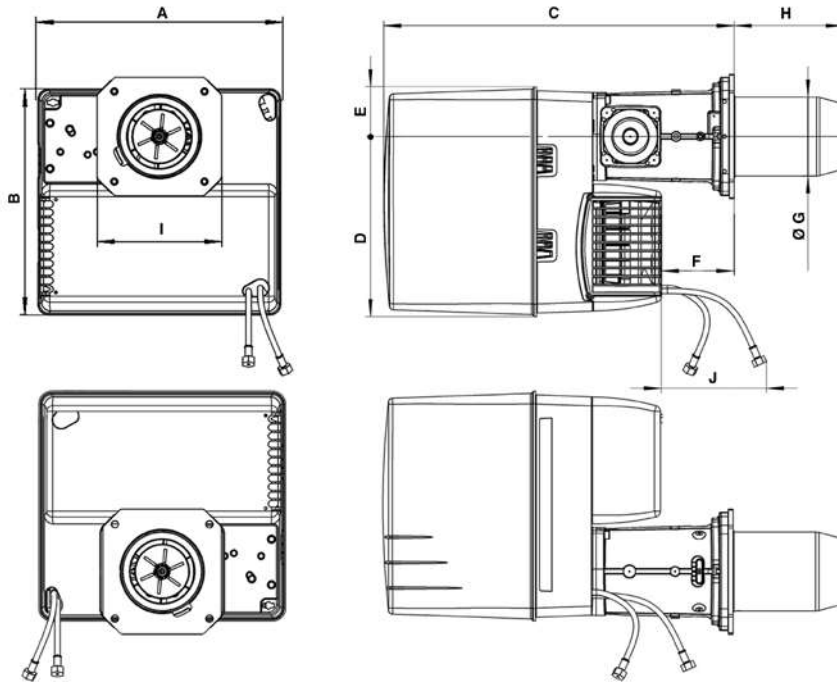

Model	A	B	C	D	E	F	ØG	H		I	J
								KN	KL		
VL3	406	379	576	297	82	120	130	180	320	195x205	1000
VL4	465	475	640	377	97	149	150	220	360	245x245	1000

Connecting flange

Model	Øa (mm)	b (mm)	c	d
VL3	155-190	175-220	M10	45°
VL4	190-240	200-270	M10	45°

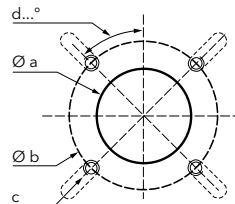

PACKAGING

The burner is delivered on a pallet in two packages containing:

- burner housing
- combustion head

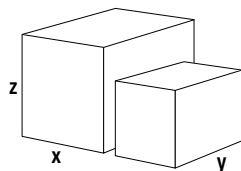

Component		Dimensions (mm)			Gross weight (kg)
		X	Y	Z	
Burner body	VL3.290 D	440	400	520	22
	VL3.360 D	440	400	520	23
	VL4.440 D	490	490	590	30
Combustion head	VL3 (KN)	650	210	260	6
	VL3 (KL)	780	210	260	7
	VL4 (KN)	750	260	295	8,5
	VL4 (KL)	895	260	295	9,7

VL4.460 D / VL4.610 D

180 ... 610 kW
Two stages



- **Fuel:** light oil (viscosity 6 mm²/s at 20°C, H_v = 11,86 kWh/kg)
- **Emissions:** NO_x < 185 mg/kWh (NCV), Low NO_x class 2 burners according to EN267
- **Protection level:** IP 41

TECHNICAL DATA

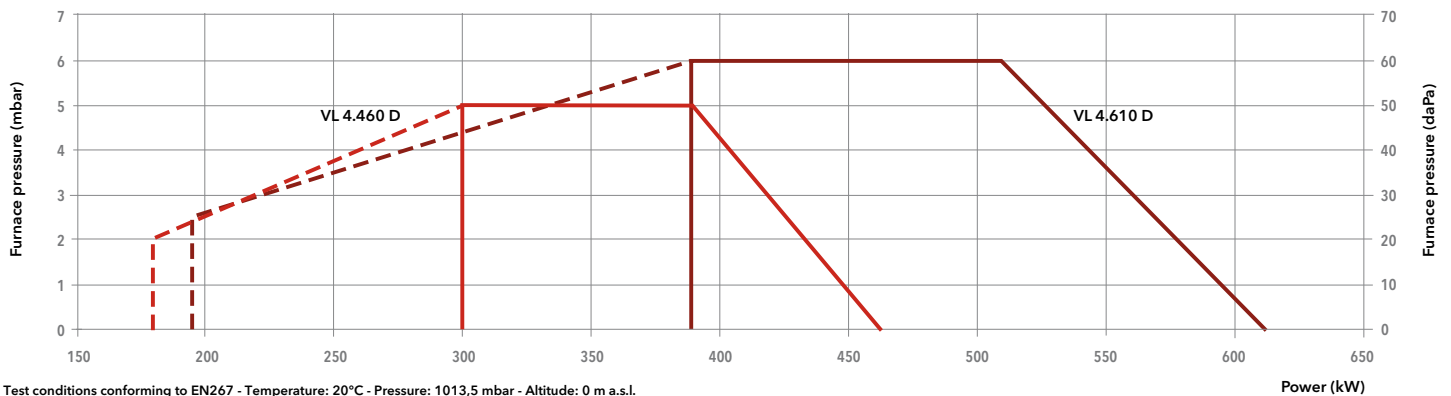

Model	VL4.460 D		VL4.610 D	
Operation range	(180) 300 - 460 kW		(195) 390 - 610 kW	
Fuel flow	(15,2) 25,3 - 38,8 kg/h		(16,4) 32,9 - 51,4 kg/h	
Nozzles	5,00 US gal/h 60°S / 3,5 US gal/h 60°S		6,50 US gal/h 60°S / 3,00 US gal/h 60°S	
Control box / flame detection	TCH2... / QRB1		TCH2... / QRB1	
Fan motor	230 V - 50 Hz - 420 W		230 V - 50 Hz - 750 W	
Electrical consumption	545 W		830 W	
Flexible hoses	Rp 3/8" / DN6 x 1500 mm		Rp 3/8" / DN6 x 1500 mm	
Acoustic level (LpA)	70 dB(A)		71 dB(A)	
Head length	KN	KL	KN	KL
Complete burner code	3833395	3833396	3833397	3833398

OTHER AVAILABLE VERSIONS

Versions for continuous ventilation and post-ventilation

SCOPE OF SUPPLY

The burner is delivered in its package complete with:

- 1 burner head with flange seal and securing screws
- 1 bag containing installation fittings
- 1 bag containing technical documentation (instruction manual, technical data, electrical diagram, exploded view and spare parts list)

DIMENSIONS (mm)

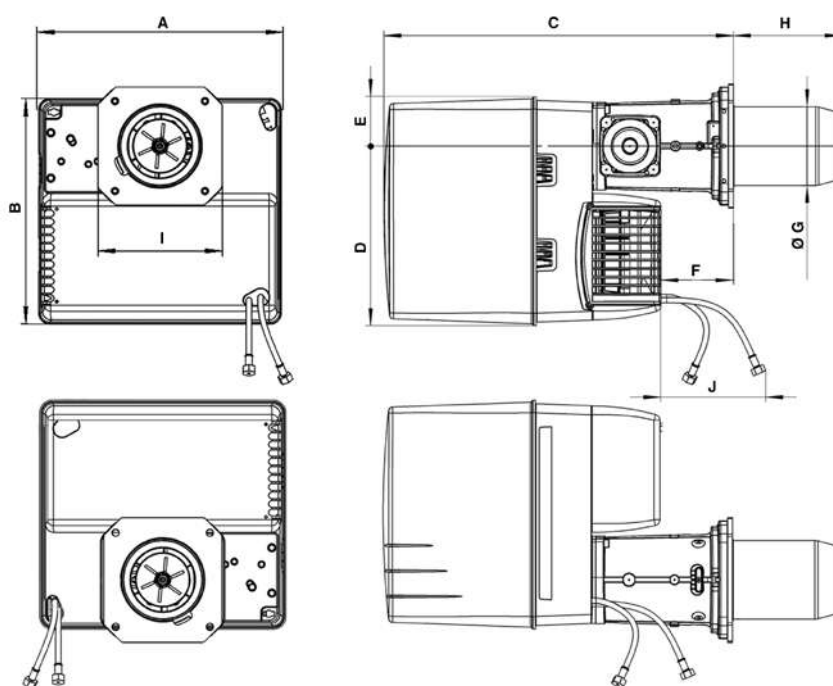

A	B	C	D	E	F	ØG	H		I	J
							KN	KL		
465	475	640	377	97	149	150	220	360	245	1000

Connecting flange

Øa (mm)	b (mm)	c	d
190-240	200-270	M10	45°

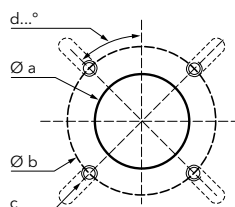

PACKAGING

The burner is delivered on a pallet in two packages containing:

- burner housing
- combustion head

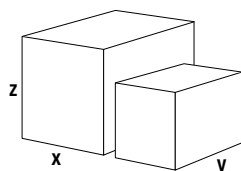

Component		Dimensions (mm)			Gross weight (kg)
		X	Y	Z	
Burner body	VL4.460 D	490	490	590	30
	VL4.610 D	490	490	590	34,2
Combustion head	KN	750	260	295	8,5
	KL	895	260	295	9,7

VL5.950 D / VL5.1200 D

260 ... 1186 kW
Two stages



- **Fuel:** light oil (viscosity 6 mm²/s at 20°C, H_v = 11,86 kWh/kg)
- **Emissions:** NO_x < 185 mg/kWh (NCV), Low NO_x class 2 burners according to EN267
- **Protection level:** IP 21

TECHNICAL DATA

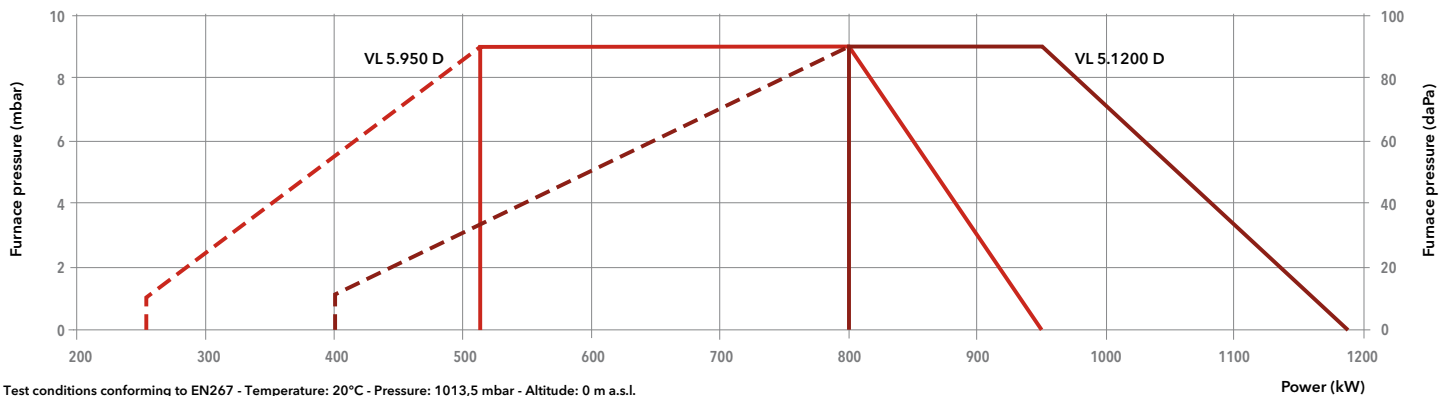

Model	VL5.950 D			VL5.1200 D		
Operation range	(260) 510 - 950 kW			(400) 800 - 1186 kW		
Fuel flow	(21,9) 43 - 80,1 kg/h			(33,7) 67,5 - 100 kg/h		
Nozzles	7,50 + 6,50 US gal/h			8,50 + 7,50 US gal/h		
Control box / flame detection	TCH2... / FTEB			TCH2... / FTEB		
Fan motor	230 V - 50 Hz - 1,5 kW			230 V - 50 Hz - 1,5 kW		
Electrical consumption	160 + 1700 W			155 + 1940 W		
Flexible hoses	Rp 3/8" / M16 x 1,5 - 1500 mm			Rp 3/8" / M16 x 1,5 - 1500 mm		
Acoustic level (LpA)	70 dB(A)			71 dB(A)		
Head length	KN	KL	KM	KN	KL	KM
Complete burner code	3833501	3833504	3833613	3833502	3833503	3833614

OTHER AVAILABLE VERSIONS

 Versions for continuous ventilation and post-ventilation

SCOPE OF SUPPLY

The burner is delivered in its package complete with:

- 1 burner head with flange seal and securing screws
- 1 bag containing installation fittings
- 1 bag containing technical documentation (instruction manual, technical data, electrical diagram, exploded view and spare parts list)

DIMENSIONS (mm)

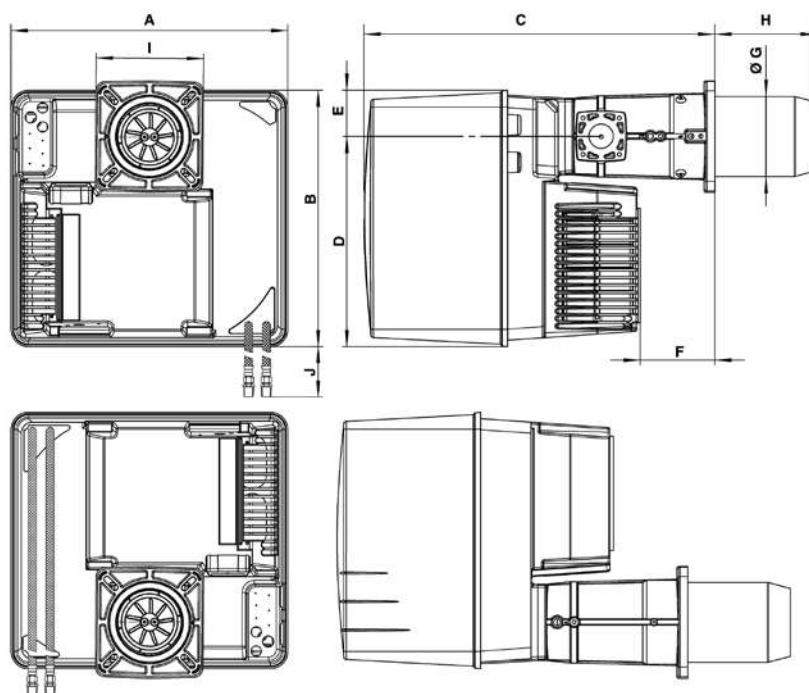

A	B	C	D	E	F	ØG	H			I	J
							KN	KM	KL		
581	549	752	450	99	164	170	215	325	435	230x238	950

Connecting flange

Øa (mm)	b (mm)	c	d
195	220-260	M10	45°

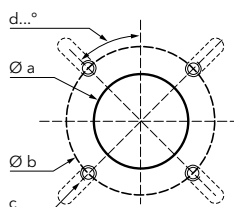

PACKAGING

The burner is delivered on a pallet in two packages containing:

- burner housing
- combustion head

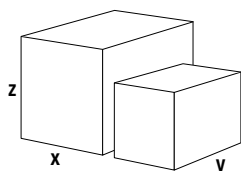

Component		Dimensions (mm)			Gross weight (kg)
		X	Y	Z	
Burner body	VL5.950 D	800	600	850	58,8
	VL5.1200 D	800	600	850	58,6
Combustion head	VL5.950 (KN)	780	265	280	10
	VL5.950 (KL)	1010	265	280	13,5
	VL5.950 (KM)	1010	265	280	12,5
	VL5.1200 (KN)	780	265	280	10,1
	VL5.1200 (KL)	1010	265	280	13,5
	VL5.1200 (KM)	1010	265	280	12

VL4.460 DP / VL4.610 DP

180 ... 610 kW
Three stages



- **Fuel:** light oil (viscosity 6 mm²/s at 20°C, H_u = 11,86 kWh/kg)
- **Emissions:** NO_x < 185 mg/kWh (NCV), Low NO_x class 2 burners according to EN267
- **Protection level:** IP 41

TECHNICAL DATA

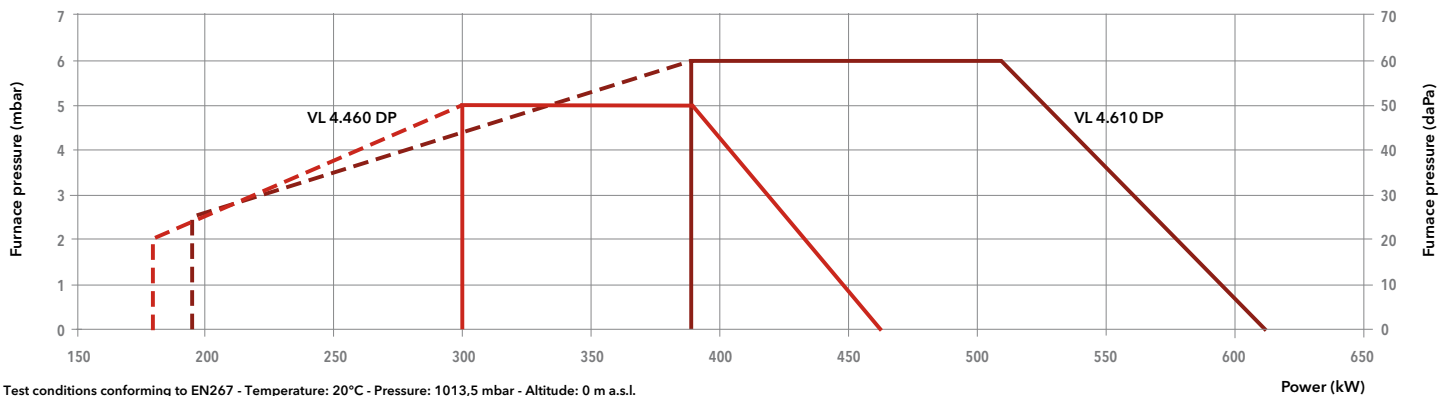

Model	VL4.460 DP		VL4.610 DP	
Operation range	(180) 300 - 460 kW		(195) 390 - 610 kW	
Fuel flow	(15,2) 25,3 - 38,8 kg/h		(16,4) 32,9 - 51,4 kg/h	
Nozzles	4,00 + 2,50 US gal/h		4,50 + 3,00 US gal/h	
Control box / flame detection	TCH3... / QRB1		TCH3... / QRB1	
Fan motor	230 V - 50 Hz - 420 W		230 V - 50 Hz - 750 W	
Electrical consumption	545 W		830 W	
Flexible hoses	Rp 3/8" / DN6 x 1500 mm		Rp 3/8" / DN6 x 1500 mm	
Acoustic level (LpA)	70 dB(A)		71 dB(A)	
Head length	KN	KL	KN	KL
Complete burner code	3833968	3833969	3833970	3833971

OTHER AVAILABLE VERSIONS

 Versions for continuous ventilation and post-ventilation

SCOPE OF SUPPLY

The burner is delivered in its package complete with:

- 1 burner head with flange seal and securing screws
- 1 bag containing installation fittings
- 1 bag containing technical documentation (instruction manual, technical data, electrical diagram, exploded view and spare parts list)

DIMENSIONS (mm)

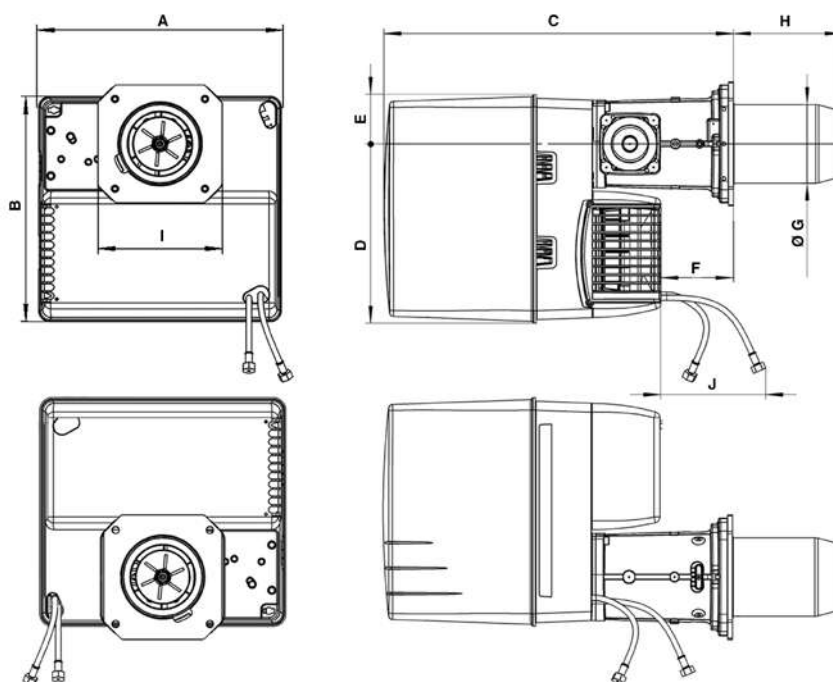

A	B	C	D	E	F	ØG	H		I	J
							KN	KL		
465	475	640	377	97	149	150	220	360	245	1000

Connecting flange

Øa (mm)	b (mm)	c	d
190-240	200-270	M10	45°

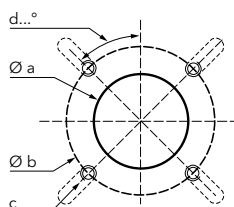

PACKAGING

The burner is delivered on a pallet in two packages containing:

- burner housing
- combustion head

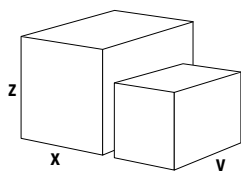

Component		Dimensions (mm)			Gross weight (kg)
		X	Y	Z	
Burner body	VL4.460 DP	490	490	590	30
	VL4.610 DP	490	490	590	34,2
Combustion head	KN	750	260	295	8,5
	KL	895	260	295	9,7

VL5.950 DP / VL5.1200 DP

260 ... 1186 kW
Three stages



- **Fuel:** light oil (viscosity 6 mm²/s at 20°C, H_v = 11,86 kWh/kg)
- **Emissions:** NO_x < 185 mg/kWh (NCV), Low NO_x class 2 burners according to EN267
- **Protection level:** IP 21

TECHNICAL DATA

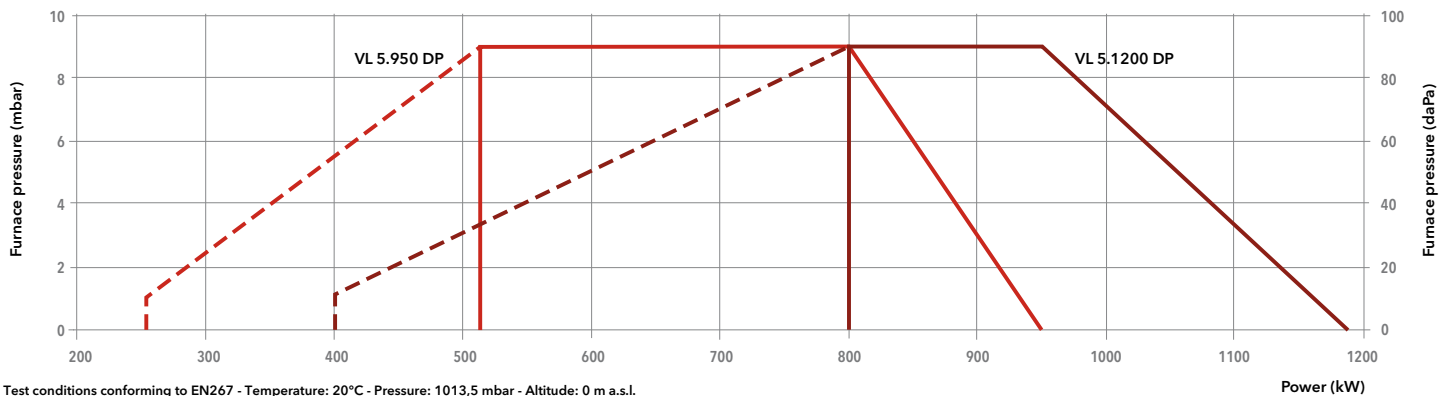

Model	VL5.950 DP			VL5.1200 DP		
Operation range	(260) 510 - 950 kW			(400) 800 - 1186 kW		
Fuel flow	(21,9) 43 - 80,1 kg/h			(33,7) 67,5 - 100 kg/h		
Nozzles	7,50 + 6,50 US gal/h			8,50 + 7,50 US gal/h		
Control box / flame detection	TCH3... / QRB1			TCH3... / QRB1		
Fan motor	230/400 V - 50 Hz - 1,5 kW			230/400 V - 50 Hz - 1,5 kW		
Electrical consumption	160 + 1700 W			155 + 1940 W		
Flexible hoses	Rp 3/8" / M16 x 1,5 - 1500 mm			Rp 3/8" / M16 x 1,5 - 1500 mm		
Acoustic level (LpA)	70 dB(A)			71 dB(A)		
Head length	KN	KL	KM	KN	KL	KM
Complete burner code	3833956	3833957	3833958	3833959	3833960	3833961

OTHER AVAILABLE VERSIONS

Versions for continuous ventilation and post-ventilation

SCOPE OF SUPPLY

The burner is delivered in its package complete with:

- 1 burner head with flange seal and securing screws
- 1 bag containing installation fittings
- 1 bag containing technical documentation (instruction manual, technical data, electrical diagram, exploded view and spare parts list)

DIMENSIONS (mm)

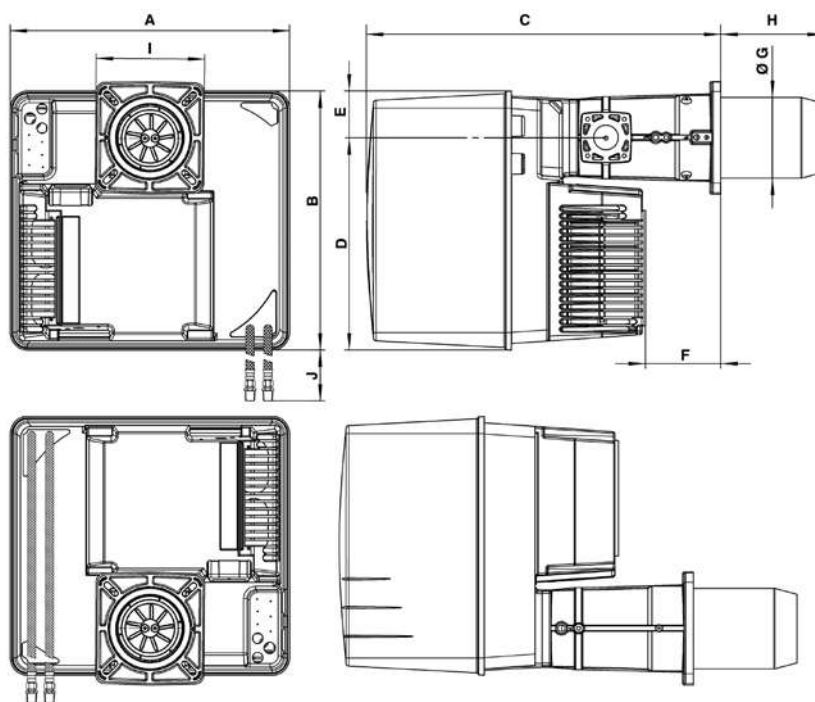

A	B	C	D	E	F	ØG	H			I	J
							KN	KM	KL		
581	549	752	450	99	164	170	215	325	435	230 x 238	950

Connecting flange

Øa (mm)	b (mm)	c	d
195	220-260	M10	45°

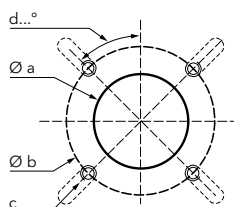

PACKAGING

The burner is delivered on a pallet in two packages containing:

- burner housing
- combustion head

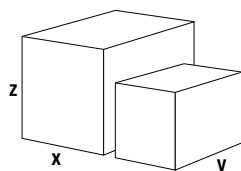

Component		Dimensions (mm)			Gross weight (kg)
		X	Y	Z	
Burner body	VL5.950 DP	800	600	850	58,8
	VL5.1200 DP	800	600	850	58,6
Combustion head	VL5.950 (KN)	780	265	280	10
	VL5.950 (KL)	1010	265	280	13,5
	VL5.950 (KM)	1010	265	280	12,5
	VL5.1200 (KN)	780	265	280	10,1
	VL5.1200 (KL)	1010	265	280	13,5
	VL5.1200 (KM)	1010	265	280	12

VL6.1600 DP / VL6.2100 DP

320 ... 2080 kW

Three stages

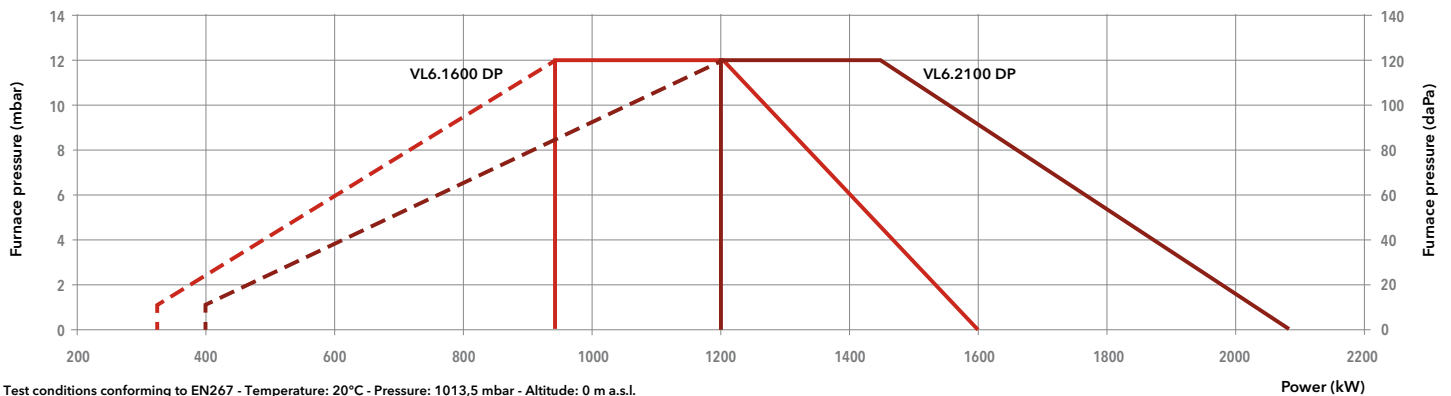

- **Fuel:** light oil (viscosity 6 mm²/s at 20°C, H_v = 11,86 kWh/kg)
- **Emissions:** NO_x < 185 mg/kWh (NCV), Low NO_x class 2 burners according to EN267
- **Protection level:** IP 21

TECHNICAL DATA

Model	VL6.1600 DP			VL6.2100 DP		
Operation range	(320) 950 - 1600 kW			(400) 1200 - 2080 kW		
Fuel flow	(27) 80,1 - 124,9 kg/h			(33,7) 101,2 - 177 kg/h		
Nozzles	3 x 6,50 US gal/h			3 x 8,50 US gal/h		
Control box / flame detection	TCH3... / QRB1			TCH3... / QRB1		
Fan motor	230/400 V - 50 Hz - 2,2 kW			230/400 V - 50 Hz - 2,5 kW		
Electrical consumption	352 + 2240 W			380 + 2840 W		
Flexible hoses	Rp 1/2" / M16 x 1,5 - 1500 mm			Rp 1/2" / M16 x 1,5 - 1500 mm		
Acoustic level (LpA)	78,1 dB(A)			79,3 dB(A)		
Head length	KN	KL	KM	KN	KL	KM
Complete burner code	3833694	3833695	3833696	3833697	3833698	3833699

OTHER AVAILABLE VERSIONS

 Versions for continuous ventilation and post-ventilation

SCOPE OF SUPPLY

The burner is delivered in its package complete with:

- 1 burner head with flange seal and securing screws
- 1 bag containing installation fittings
- 1 bag containing technical documentation (instruction manual, technical data, electrical diagram, exploded view and spare parts list)

DIMENSIONS (mm)

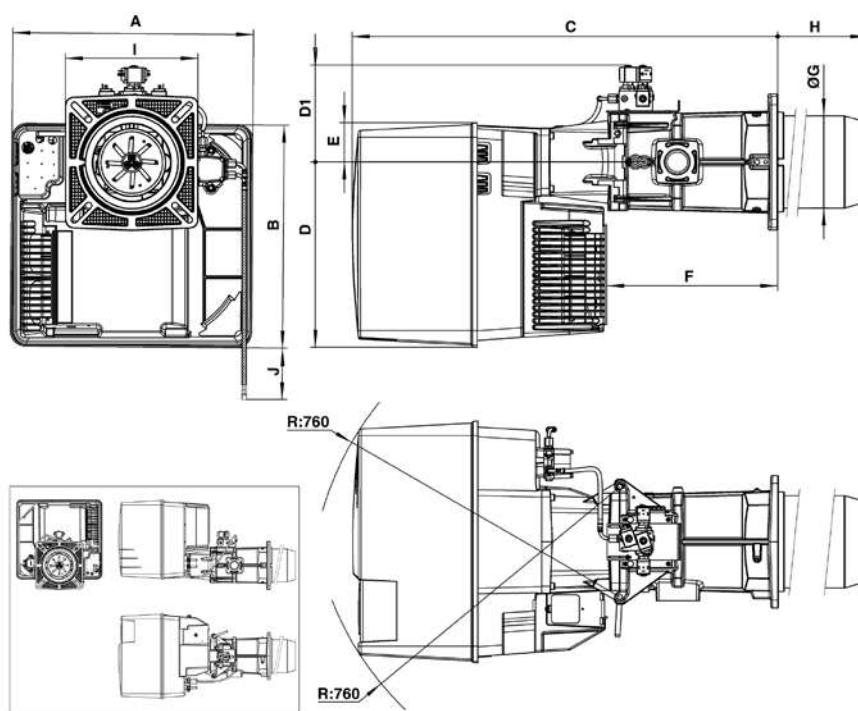

A	B	C	D	D1	E	F	ØG	H			I	J
								KN	KM	KL		
592	553	1050	456	239	97	421	227	270	370	470	326x335	950

Connecting flange

Øa (mm)	b (mm)	c	d
250	300-400	M12	45°

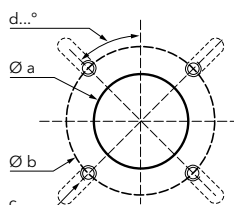

PACKAGING

The burner is delivered on a pallet in two packages containing:

- burner housing
- combustion head

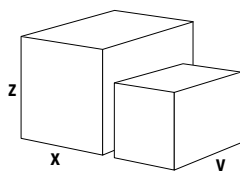

Component		Dimensions (mm)			Gross weight (kg)
		X	Y	Z	
Burner body	VL6.1600 DP	800	600	850	79,4
	VL6.2100 DP	800	600	850	79,6
Combustion head	VL6.1600 (KN)	800	380	420	42
	VL6.1600 (KL)	1000	420	380	29,8
	VL6.1600 (KM)	1000	420	380	28,3
	VL6.2100 (KN)	800	380	420	24
	VL6.2100 (KL)	1000	380	420	42
	VL6.2100 (KM)	1000	380	420	42

VL1.40 BIO / VL1.70 BIO / VL1.100 BIO

16 ... 100 kW
One stage

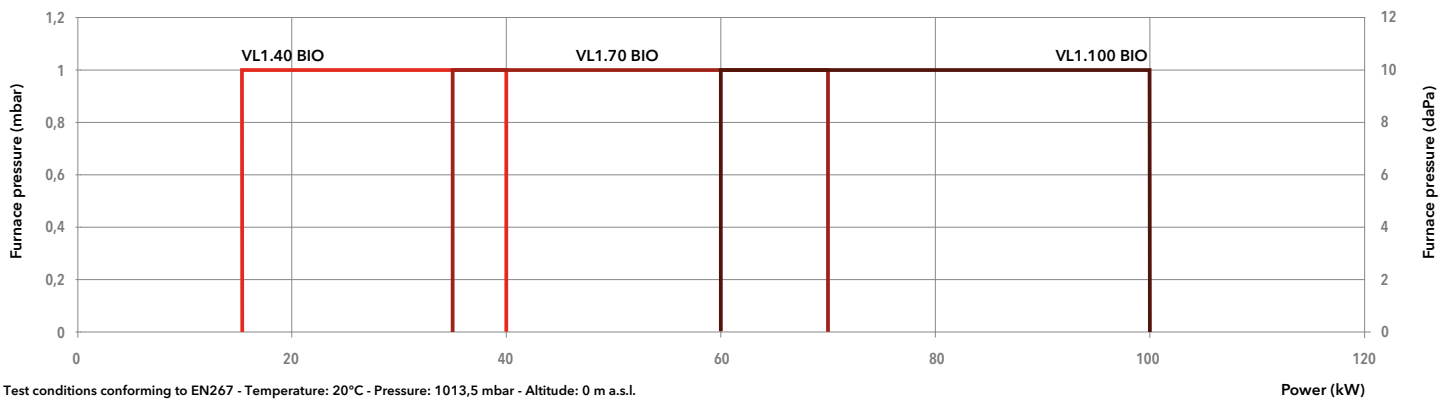

- **Fuel:** light oil and Eco fuel oil F30 (viscosity 6 mm²/s at 20°C, H_u = 11,86 kWh/kg)
- **Emissions:** NO_x < 100 mg/kWh (NCV), burners compliant with ErP Directive
- **Protection level:** IP 21

TECHNICAL DATA

Model	VL1.40 BIO	VL1.70 BIO	VL1.100 BIO
Operation range	16 - 40 kW	35 - 70 kW	60 - 100 kW
Fuel flow	1,3 - 2,9 kg/h	2,4 - 4,2 kg/h	3,7 - 6,3 kg/h
Nozzle	0,65 US gal/h 45°S	1,1 US gal/h 45°S	2,25 US gal/h 45°H
Control box / flame detection	TCH1... / QRB1	TCH1... / QRB1	TCH1... / QRB1
Fan motor	230 V - 50 Hz - 110 W	230 V - 50 Hz - 110 W	230 V - 50 Hz - 110 W
Electrical consumption	244 W	244 W	233 W
Flexible hoses	Rp 3/8" / M14 x 1,5 - 1000 mm	Rp 3/8" / M14 x 1,5 - 1000 mm	Rp 3/8" / M14 x 1,5 - 1000 mm
Acoustic level (LpA)	65 dB(A)	65 dB(A)	65 dB(A)
Head length	KN	KN	KN
Complete burner code	3837225	3837226	3837227

OTHER AVAILABLE VERSIONS

 Versions for continuous ventilation and post-ventilation

SCOPE OF SUPPLY

The burner is delivered in its package complete with:

- 1 setting template
- 1 burner flange with insulation
- 1 bag containing installation fittings
- 1 bag containing technical documentation (instruction manual, technical data, electrical diagram, exploded view and spare parts list)



DIMENSIONS (mm)

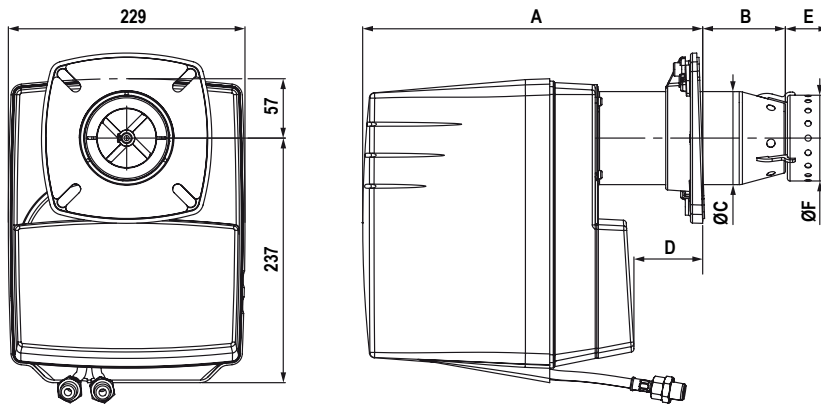

Model	A	B	ØC	D	E	ØF
VL1.40 BIO	264 ... 329	70 ... 145	90	12 ... 77	42	83
VL1.70 BIO	264 ... 344	70 ... 145	90	12 ... 92	45	83
VL1.100 BIO	297 ... 357	70 ... 138	90	15 ... 83	56	83

Connecting flange

Øa (mm)	b (mm)	c	d
95-104	150-170	M8	45°

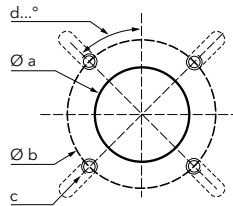

PACKAGING

The burner is delivered in a single package containing all the components

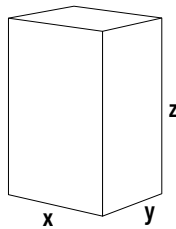

	Dimensions (mm)			Gross weight (kg)
	X	Y	Z	
VL1.40 BIO	300	260	650	11
VL1.70 BIO	300	260	650	11
VL1.100 BIO	300	260	650	12

A modulating burner allows to adapt the power delivered according to the boiler/system requirements.

To obtain the modulating operation it is necessary to install a power regulator and the relative temperature or pressure probes, chosen in accordance with the specific requirements of the installation.

To simplify the selection of regulator and probes ELCO offers specific kits mounted in factory on the burner:

Kit RWF 50 with sensor

RWF 50 is a basic controller with analog output or 3-position output

Description	Burners	Code
Kit GEP130 (water - immersion probe)	V2	3834039
Kit GEA130 (water - strap-on probe)	V2	3834040
Kit IEP130 (water - immersion probe)	V3	3834043
Kit IEA130 (water - strap-on probe)	V3	3834044
Kit LEP130 (water - immersion probe)	V4	3834047
Kit LEA130 (water - strap-on probe)	V4	3834048
Kit MEP130 (water - immersion probe)	V5 and V6	3834049
Kit MEA130 (water - strap-on probe)	V5 and V6	3834050
MIF001R (kit mounted in factory)	V2 to V6	on request



Example:

Kit with immersion probe with working field limitation up to 130°C for water tube boiler, mounted in factory on a VG2.210 D E

Kit GEP130
(water - immersion probe)
3834039

+

MIF001R
(kit mounted
in factory)

Kit RWF 55 with sensor

RWF 55 offers some more functions, such us:

- Modbus slave RS485 interface as standard
- 3 analog inputs
- Accepts thermocouples J, K, N, T, etc. as input
- Analog output DC 0(4)...20mA or 0...10V

Description	Burners	Code
Kit LEP 130 (water - immersion sensor)	V5 and V6	3834602
Kit LEA 130 (water - strap-on probe)	V5 and V6	3834603
Kit LVA 16 (steam - pressure probe)	V5 and V6	3834604
Acc AQE21.02 (kit for using Kit LEP 130 on hot air generator)	V5 and V6	3834307
MIF001R (kit mounted in factory)	V5 and V6	on request



Example:

Kit with pressure probe for steam boiler, mounted in factory on a VG5.950 DP

Kit LVA 16
(steam - pressure probe)
3834604

+

MIF001R
(kit mounted
in factory)

RWF 50 stand-alone and wiring kit

Description	Burners	Code
Load controller RWF50 SA	V2 to V6	3833498
Wiring kit RWF50 EW03	V2	3834056
Wiring kit RWF50 EW04	V3	3834057
Wiring kit RWF50 EW05	V4	3834058
Wiring kit RWF50 W06-07	V5 and V6	3834032



Example:
Power regulator RWF50 for VG3.290 DP E and wiring kit

Load controller
RWF50 SA
3833498

+

Wiring kit
RWF50 EW04
3834057

RWF 55 stand-alone and wiring kit

Description	Burners	Code
Load controller RWF55 SA	VG5 and VG6*	3834298
Wiring kit RWF55 W06-07	VG5 and VG6*	3834299
Load controller RWF55.5	EK EVO 4 and 5	3147730



*: for models VGL5 and VGL6 the RWF55 must be installed in our factory; contact us in case of order

Example:
Power regulator RWF55 for VG5.1200 DP and wiring kit

Load controller
RWF55 SA
3834298

+

Wiring kit
RWF55 W06-07
3834299

Example:
Power regulator RWF55 for EK EVO 4.1000 L-EOT

Load controller
RWF55.5
3147730

Separated sensors

Description	Burners	Code
Acc TIP 130 (Immersion probe, water 130°C)	V2 to V6	3833163
Acc TSP 130 (Strap-on probe, water 130°C)	V2 to V6	3833165
Acc TIP 400 (Hot water/air probe Pt100 / 400°C - L = 160 mm)	V2 to V6	65300274
Acc QBE2002-P1 (0 ... 1 bar)	V2 to V6	3834310
Acc QBE2002-P2 (0 ... 2 bar)	V2 to V6	3834311
Acc QBE2002-P4 (0 ... 4 bar)	V2 to V6	3834312
Acc QBE2002-P10 (0 ... 10 bar)	V2 to V6	3834313
Acc QBE2002-P16 (0 ... 16 bar)	V2 to V6	3834305
Acc QBE2002-P25 (0 ... 25 bar)	V2 to V6	3834314
Acc AQB2.1 (QBE sensor support)	V2 to V6	3834309
Acc AQB2001 (1 meter connection pipe)	V2 to V6	3834308
Acc QAC22 (external probe)	V2 to V6	13018513



O₂ TRIM for BT3xx

This kit is used to optimize the combustion in order to keep the air excess as much stable as possible irrespective of the changes that can occur during operations, for instance slight calorific value variations, combustion air temperature and pressure. This improves the seasonal efficiency and therefore reduces the fuel consumption. The kit includes the following components:

- Lambda transmitter LT3
- Lambda probe LS2
- Probe installation fitting (PIF)
- Gas extraction device (GED)

The control unit has to be installed close to the probe (max 25 m of cable).

The probe needs a calibration but no reference gas is necessary.

The display shows the O₂ content.

Maximum distance between the LT3 and the burner control panel is 500 m.

Description	Additional LSB modules installed at LT3	GED length	Code
Kit for O₂ trim (LT3 + LS2) Flue temp max 300 °C - Display for O₂ visualization (Note: for models equipped with BT3xx this kit needs a LCM module installed in the burner control panel)	none	150 mm	3759296
		300 mm	3759297
		450 mm	3759298
	4x 0/4-20 mA output	150 mm	3759299
		300 mm	3759300
		450 mm	3759301
	4x 0/4-20 mA output + 4x digital output	150 mm	3759302
		300 mm	3759303
		450 mm	3759304

The lambda probe LS2 is equipped with a 2 m long connection cable to connect the probe to the transmitter (LT3). This connection cable can be extended by a maximum of 23 m (total of 25 m). For longer distances the admission does expire. Therefore, there are ready-made cables as well as the probes connection box (PCB).

The PCB is a small terminal box that is connected to the 2 m cable already existing on the probe. The wiring between the PCB and the transmitter must be carried out on the construction site with suitable cables and trained personnel.

Description	Code
Extension LS2 PCB ⁽¹⁾	3759317
Extension LS2 cable 5m	3759314
Extension LS2 cable 10m	3759315
Extension LS2 cable 20m	3759316

⁽¹⁾: the PCB is mandatory when an extension cable is needed

O₂ TRIM with CO measure for BT3xx

This kit is used for optimizing the combustion in order to keep the air excess as low as possible in order to maximize the seasonal efficiency and therefore minimize the fuel consumption. In addition to the features of the O₂ trim only, this kit reduces the air excess to its minimum because this system continuously measures the content of unburned fuel (CO_e) in the flue: should the air excess be reduced too much, the CO_e raises and the system reacts by increasing the air excess in order to keep firing in safe conditions. The kit includes the following components:

- Lambda transmitter LT3-F
- Lambda probe KS1D
- Probe installation fitting (PIF)
- Gas extraction device (GED)

The control unit has to be installed close to the probe (max 10 m of cable).

The probe needs a calibration but no reference gas is necessary.

The display shows the O₂ and CO_e content.

Maximum distance between the LT3-F and the burner control panel is 500 m.

Description	Additional LSB modules installed at LT3-F	GED length	Code
Kit for O₂ trim and CO control (LT3-F + KS1D) Flue temp max 300 °C (Note: for models equipped with BT3xx this kit needs a LCM module installed in the burner control panel)	none	150 mm	3759305
		300 mm	3759306
		450 mm	3759307
	4x 0/4-20 mA output	150 mm	3759308
		300 mm	3759309
		450 mm	3759310
	4x 0/4-20 mA output + 4x digital output	150 mm	3759311
		300 mm	3759312
		450 mm	3759313

The lambda probe KS1D is equipped with a 2 m long connection cable to connect the probe to the transmitter (LT3-F). This connection cable can be extended by a maximum of 8 m (total of 10 m). For longer distances the admission does expire. Therefore, there is a ready-made cable as well as the probes connection box (PCB).

The PCB is a small terminal box that is connected to the 2 m cable already existing on the probe. The wiring between the PCB and the transmitter must be carried out on the construction site with suitable cables and trained personnel.

Description	Code
Extension KS1D PCB ⁽¹⁾	3759319
Extension KS1D cable 5m	3759318

⁽¹⁾: the PCB is mandatory when an extension cable is needed

Kit LCM for BT3xx

Description	Burners	Code
Analog input and output (chosen among 0-10 V and 4-20 mA)	V2 M to V6 M	3836239
	EK EVO 4/5	3147726

Communication modules

Description	Burners	Code
ModBus/BT3 (EBM100) mounted on the burner	EK EVO 4/5	3147727
ProfiBus/BT3 (PBM100) mounted on the burner	EK EVO 4/5	3147728
ModBus/BT3 (EBM100) for external installation	V2 M to V6 M and EK EVO 4/5	3754456
ProfiBus/BT3 (PBM100) for external installation	V2 M to V6 M and EK EVO 4/5	3752986

Display

Description	Burners	Code
Lamtec UI300 display (to be mounted on the control box instead of the native display)	EK EVO 4/5	3147729

Remote software

Description	Burners	Code
Kit to connect a PC laptop to BT3xx for its parametrization (LSA100 + USB/CAN + cd-rom)	V2 M to V6 M	3751130

MDE2 System

Description	Burners	Code
PC interface tool to connect the control box to a personal computer allowing transmission of burner operation data, fault signals and service information	V1 and V2	3148650

Cable for 0-10V load input ⁽¹⁾ (applicable to Ariston TCG2/TCH2 or higher)

Description	Burners	Code
Kit 0-10V BCU/0	V2 to V6	3834253

⁽¹⁾: the 0-10 V must be exchanged with a device with the electric feeding shared with the burner. Alternatively a galvanic separator (code 3144698) must be fitted

Cable for 0-10V load input ⁽¹⁾ + potentiometer for actuator position feedback (applicable to Ariston TCG2/TCH2 or higher)

Description	Burners	Code
Kit 0-10V BCU/1	V2, V3, V4	3834170
Kit 0-10V BCU/2	V5, V6	3834171

⁽¹⁾: the 0-10 V must be exchanged with a device with the electric feeding shared with the burner. Alternatively a galvanic separator (code 3144698) must be fitted

Analog signal converter and galvanic separator ⁽²⁾ (applicable to Ariston TCG2/TCH2 or higher)

Description	Burners	Code
Conversion among 0-10 V, 4-20 mA, 0-20 mA signals	V2 to V6	3144698

⁽²⁾: all the items provided with code 3834253 are already included in this kit

Front boiler flange

Description	Burners	Code
CP1	V1	13018495
CP2	V2	13018496
CP3.1	V3	3833151
CP4	V4 and V5	13018499
CP5.1	V6	13008019

Sound proofing box - noise reduction 15...20 dB(A)

Description	Burners	Code
CI20	V2	on request
CI21	V3	on request
CI22	V4	on request
CI23	V5	on request
CI24	V6	on request

Sound proofing box - noise reduction 20...30 dB(A)

Description	Burners	Code
CI31	V3	on request
CI32	V4	on request
CI33	V5	on request
CI34	V6	on request

External air intake connection kit

Description	Burners	Code
Kit RG4 (Ø 50mm, directable)	VB1.20 to V1.55	13004320
Kit RG9 (Ø 50)	VB1.20 to VB1.95	13011996
Kit RG10 (Ø 100)	V2	13018822
Kit RG11 (Ø 160)	V3	3833152
Kit RG12 (Ø 200)	V4	3833429
Kit RG3 (Ø 250)	V5 and V6	13014375

External valve connection kit

Description	Burners	Code
Connector for safety solenoid valve	V1 to V4	13010959

Maximum gas pressure switch

Description	Burners	Code
Kit for burners fitted with Artison BCU TCxx	V1 to V6	3833903
Kit for burners fitted with BT3xx	V2 M... to V6 M...	3836857

Gas and air manometer with push button

Description	Code
AGM 0-60mbar	13002181
AGM 0-100mbar	13018509
AGM 0-400mbar	13018510

Gas filter

Description	Code
RP 15 - 1/2"	3141957
RP 20 - 3/4"	3142045
RP 25 - 1"	3142046
RP 40 - 1"1/2	3141954
RP 50 - 2"	3121384
DN 65 - 2"1/2	3124111
DN 80 - 3"	3142088
DN 100 - 4"	3142205
DN 125 - 5"	3142206

Antivibration coupling - Compensator

Description	Code
RP 1/2" threaded connection	3122321
RP 3/4" threaded connection	3122322
Rp 1" threaded connection	3122323
RP 1"1/4 threaded connection	3122324
Rp 1"1/2 threaded connection	3122325
Rp 2" threaded connection	3122326
DN50 flanged connection	12001014
DN65 flanged connection	3142060
DN80 flanged connection	3122328
DN100 flanged connection	3122329
DN125 flanged connection	3142061

Ball valve

Description	Code
Rp 1/2" threaded connection	3142000
Rp 3/4" threaded connection	3142254
Rp 1" threaded connection	3121430
Rp 1"1/4 threaded connection	3142253
Rp 1"1/2 threaded connection	3142101
Rp 2" threaded connection	3142102
DN65 flanged connection	3142062
DN80 flanged connection	3143730
DN100 flanged connection	3141997
DN125 flanged connection	3141998

Kit Variatron

Description	Burners	Code
Kit Variatron 1,5 KW	VG5.950/1200 DP	3836887
Kit Variatron 2,2 KW	VG6.1600 DP	3836888
Kit Variatron 3 KW	VG6.2100 DP	3836889

Kit remote reset

Description	Burners	Code
Kit for burners fitted with Artison BCU TCxx	V1 to V6	13011486
Kit for burners fitted with BT3xx	V2 M... to V6 M...	3144622

Kit additional oil safety valve

Description	Burners	Code
Kit OSV 01/02/03	V1 and V2	3832706
Kit OSV 06	V5	3834195

"Flame on" digital output (BT300)

Description	Burners	Code
Kit ROS BT3	V2 M to V6 M	3144260

Subsidiaries ELCO

GERMANY

ELCO GmbH
Dreieichstraße 10
Mörfelden-Walldorf
Tel. +49 (0)6105 287-287
Fax +49 (0)6105 287-199

NETHERLANDS

Elco Burners B.V.
Meerpaalweg, 1
1332 BB Almere
P.O. box 30048
1303 AA Almere
Tel. +31 088 69 573 11
Fax +31 088 69 573 90

FRANCE

14, rue du Saule Trapu
Parc d'activité du Moulin
91882 Massy
Tel. +33 01 60 13 64 64
Fax +33 01 60 13 64 65

SWITZERLAND

Elcotherm AG
Sarganserstrasse 100
7324 Vilters
Tel. +41 (0)81 725 25 25
Fax +41 (0)81 723 13 59

AUSTRIA

ELCO Austria GmbH
Aredstraße 16 - 18
2544 Leobersdorf
Tel. +43 (0)2256 639 99 32
Fax +43 (0)2256 644 11

ITALY

Via Roma, 64
31023 Resana (TV)
Tel. +39 0423 719 500
Fax +39 0423 719 580

UK & IRELAND

Ariston Thermo UK Ltd
Suite 3, The Crown House
Blackpole East, Blackpole Road,
Worcester WR3 8SG
Tel. +44 01905 788010
Fax +44 01905 788011

RUSSIA

Ariston Thermo RUS
Eniseyskaya str. 1, bld 1,
Office Center "LIRA" #438
129344 Moscow
Tel. +7 495 213 0300 #5700
Fax +7 495 213 0302

CHINA

Ariston Thermo (China) Co., Ltd.
F/15, V-Capital Bldg
No. 333 Xian Xia Road
200336 Shanghai
Tel. +86 21 6039 8691
Fax +86 21 6039 8620

Contact us to know more
about our products and solutions

www.elco-burners.com
contact@elco-burners.com

Version 2.1 | 16/01/2023

All rights reserved | ELCO declines all responsibility for any printing mistakes or any content transcription in the present document and reserves the right to modify, without prior notice, any product datas or characteristics